

H 90 COBRE Cobre | 110.0270.807

FAMILY : **Campanas** | SERIES : **TENDER** | MODEL : **H 90 COBRE** | FINISH : **Cobre** | INSTALLATION TYPE : **T invertida**

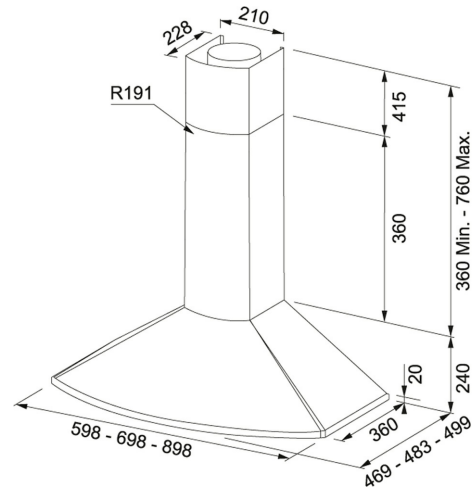

DATOS TÉCNICOS

Potencia Máx. (W)	250 W
Total Power	254 W
Iluminación	LEDS-2X4W
Aspiración en Mín. (UNE EN-61591)	300 m3/h
Aspiración en Máx. (UNE EN-61591)	620 m3/h
Pot. Sonora en Mín. (UNE EN-60704-3)	50 dB(A)
Pot. Sonora en Máx. (UNE EN-60704-3)	66 dB(A)
Tipo de Mandos	Pulsantes
Ancho	90,00 cm
Tipo de campana	Decorativa
Clase Energética	C
Salida	Ø-120---150-MM
Voltage	220-240V
Pressure	500,00 Pa
Grease filter	Filtros de Aluminio
Type of motor	Energy 800 Plus
Acabado	COPPER
Dimensions	900X500