

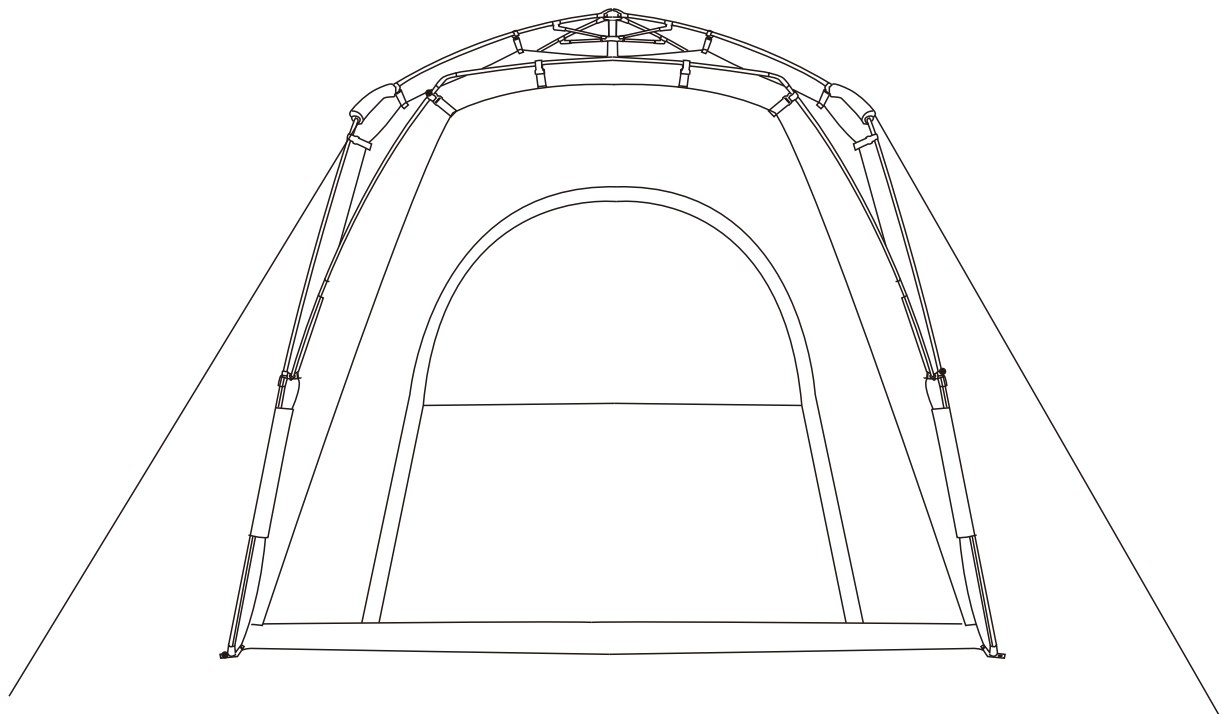

IN221100039V01_GL

A20-054



EN_ IMPORTANT, RETAIN FOR FUTURE REFERENCE: READ CAREFULLY.

FR_ IMPORTANT: A LIRE ATTENTIVEMENT ET À CONSERVER POUR CONSULTATION ULTÉRIEURE.

ES_ IMPORTANTE, LEA Y GUARDE PARA FUTURAS REFERENCIAS.

PT_ IMPORTANTE, RETER PARA REFERÊNCIA FUTURA: LEIA ATENTAMENTE.

DE_ WICHTIG! SORGFÄLTIG LESEN UND FÜR SPÄTER NACHSCHLAGEN AUFBEWAHREN.

IT_ IMPORTANTE! CONSERVARE IL PRESENTE MANUALE PER FUTURO RIFERIMENTO E LEGGERLO ATTENTAMENTE.



WARNING: KEEP ALL FLAME AND HEAT SOURCES AWAY FROM THIS TENT.

This tent is not fireproof. The fabric will burn if left in continuous contact with a flame source.

Precautions

- Do NOT use candles, matches or other open flames in or near a tent.
- Fuel-powered lanterns and appliances are NOT recommended for use in or near a tent. If fuel-powered lanterns or appliances such as wood stoves or electric heaters are used, **exercise extreme caution**. Keep them away from the tent walls. Do NOT leave them unattended. Turn them off before going to sleep. Make sure the tent is well ventilated at all times to avoid suffocation.
- Build campfires downwind and several metres away from a tent. Extinguish campfires before leaving a campsite or going to sleep.
- Do NOT fuel lamps, heaters or stoves in a tent.
- Do NOT smoke in a tent.
- Do NOT store flammable liquids in a tent.
- Keep exits clear.
- Do NOT apply any foreign substance to a tent. It may diminish the flame resistant properties of tent material(s).



MISE EN GARDE : TENIR CETTE TENTE LOIN DE TOUTE FLAMME ET DE TOUTE SOURCE DE CHALEUR.

Cette tente n'est pas ininflammable. Le tissu brûlera s'il est laissé en contact continu avec une source de flamme.

Précautions

- NE PAS utiliser de bougies, d'allumettes ou d'autres flammes nues à l'intérieur ou à proximité d'une tente.
- Les lanternes et les appareils utilisant un combustible NE sont PAS recommandés pour une utilisation à l'intérieur ou à proximité d'une tente. Si vous utilisez des lanternes ou des appareils à combustible, tels que des poêles à bois ou des radiateurs électriques, **faites preuve d'une extrême prudence**. Gardez-les loin des parois de la tente. NE les laissez PAS sans surveillance. Éteignez-les avant d'aller vous coucher. Assurez-vous que la tente est toujours bien ventilée pour éviter l'asphyxie.
- Construire les feux de camp sous le vent et à plusieurs mètres d'une tente. Éteindre les feux de camp avant de quitter un emplacement de camping ou d'aller se coucher.
- NE PAS faire le plein de lampes, d'appareils de chauffage ou de cuisinières dans une tente.
- NE PAS fumer dans une tente.
- NE PAS entreposer de liquides inflammables dans une tente.
- Garder les sorties dégagées.
- NE PAS appliquer de substances étrangères sur une tente. Cela peut diminuer les propriétés ignifuges des matériaux de la tente.



WARNUNG: HALTEN SIE ALLE FLAMMEN UND WÄRMEQUELLEN VON DIESEM ZELT FERN.

Dieses Zelt ist nicht feuerfest. Der Stoff wird brennen, wenn er in ständigem Kontakt mit einer Flamme bleibt.

Vorsichtsmaßnahmen

- Verwenden Sie KEINE Kerzen, Streichhölzer oder andere offene Flammen in oder in der Nähe eines Zeltes.
- Kraftstoffbetriebene Laternen und Geräte werden NICHT für die Verwendung in oder in der Nähe eines Zeltes empfohlen. Wenn kraftstoffbetriebene Laternen oder Geräte wie Holzöfen oder elektrische Heizungen verwendet werden, **ist äußerste Vorsicht geboten**. Halten Sie sie von den Zeltwänden fern. Lassen Sie sie NICHT unbeaufsichtigt. Schalten Sie sie aus, bevor Sie schlafen gehen. Stellen Sie sicher, dass das Zelt jederzeit gut belüftet ist, um Erstickung zu vermeiden.
- Lagerfeuer im Lee und mehrere Meter von einem Zelt entfernt aufbauen. Lagerfeuer vor dem Verlassen eines Campingplatzes oder vor dem Schlafengehen löschen.
- Füllen Sie keine Lampen, Heizungen oder Öfen in einem Zelt mit Brennstoff.
- Rauchen Sie NICHT in einem Zelt.
- Lagern Sie brennbare Flüssigkeiten nicht in einem Zelt.
- Halten Sie die Ausgänge frei.
- Wenden Sie keine fremden Substanzen auf einem Zelt an. Dies kann die flammhemmenden Eigenschaften des Zeltmaterials beeinträchtigen.



ADVERTENCIA: MANTENGA TODAS LAS FUENTES DE LLAMA Y CALOR LEJOS DE ESTA TIENDA.

Esta tienda no es a prueba de fuego. La tela se quemará si se deja en contacto continuo con una fuente de llama.

Precauciones

- No use velas, fósforos ni otras llamas abiertas dentro o cerca de una tienda.
- No se recomiendan las linternas y aparatos a combustible para su uso dentro o cerca de una tienda de campaña. Si se utilizan linternas o aparatos a combustible, como estufas de leña o calefactores eléctricos, **ejerza extrema precaución**. Manténgalos alejados de las paredes de la tienda. NO los deje desatendidos. Apáguelos antes de irse a dormir. Asegúrese de que la tienda esté bien ventilada en todo momento para evitar la asfixia.
- Haga fogatas a favor del viento y a varios metros de distancia de una tienda. Apague las fogatas antes de abandonar un campamento o de irse a dormir.
- No abastezca de combustible lámparas, calefactores o estufas en una tienda.
- No fume en una tienda.
- No almacene líquidos inflamables en una tienda.
- Mantenga las salidas despejadas.
- No aplique ninguna sustancia extranjera a una tienda. Puede disminuir las propiedades de resistencia a la llama del material de la tienda.



ADVERTÊNCIA: MANTENHA TODAS AS FONTES DE CHAMA E CALOR LONGE DESTA TENDA.

Esta tenda não é à prova de fogo. O tecido queimará se mantido em contato contínuo com uma fonte de chama.

Precauções

- Não use velas, fósforos ou outras chamas abertas dentro ou perto de uma tenda.
- Lanternas e aparelhos a combustível **NÃO** são recomendados para uso dentro ou perto de uma tenda. Se lanternas ou aparelhos a combustível, como fogões a lenha ou aquecedores elétricos, forem usados, **tenha extrema cautela**. Mantenha-os afastados das paredes da tenda. **NÃO** os deixe sem supervisão. Desligue-os antes de ir dormir. Certifique-se de que a tenda esteja bem ventilada em todos os momentos para evitar sufocamento.
- Faça fogueiras a favor do vento e a vários metros de distância de uma tenda. Apague as fogueiras antes de deixar o acampamento ou ir dormir.
- Não abasteça lâmpadas, aquecedores ou fogões dentro de uma tenda.
- Não fume em uma tenda.
- Não armazene líquidos inflamáveis em uma tenda.
- Mantenha as saídas desobstruídas.
- Não aplique nenhuma substância estranha a uma tenda. Isso pode diminuir as propriedades de resistência ao fogo do(s) material(is) da tenda.



AVVERTENZA: TENERE TUTTE LE FONTI DI FIAMMA E CALORE LONTANO DA QUESTA TENDA.

Questa tenda non è ignifuga. Il tessuto brucerà se lasciato a contatto continuo con una fonte di fiamma.

Precauzioni

- Non utilizzare candele, fiammiferi o altre fiamme libere dentro o vicino a una tenda.
- Le lanterne e gli apparecchi a combustibile **NON** sono raccomandati per l'uso dentro o vicino a una tenda. Se si utilizzano lanterne o apparecchi a combustibile come stufe a legna o riscaldatori elettrici, **esercitare la massima cautela**. Tienili lontani dalle pareti della tenda. **NON** lasciarli incustoditi. Spegnili prima di andare a dormire. Assicurati che la tenda sia ben ventilata in ogni momento per evitare soffocamenti.
- Accendere fuochi da campo sottovento e a diversi metri di distanza da una tenda. Spegnere i fuochi da campo prima di lasciare un campeggio o andare a dormire.
- Non alimentare lampade, riscaldatori o stufe in una tenda.
- Non fumare in una tenda.
- Non conservare liquidi infiammabili in una tenda.
- Tenere le uscite libere.
- Non applicare alcuna sostanza estranea a una tenda. Potrebbe ridurre le proprietà di resistenza al fuoco dei materiali della tenda.

A x01



B x04



C x08



01

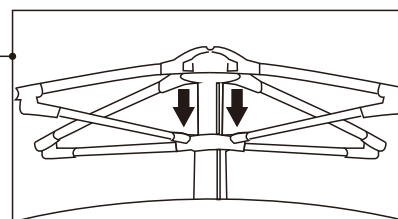
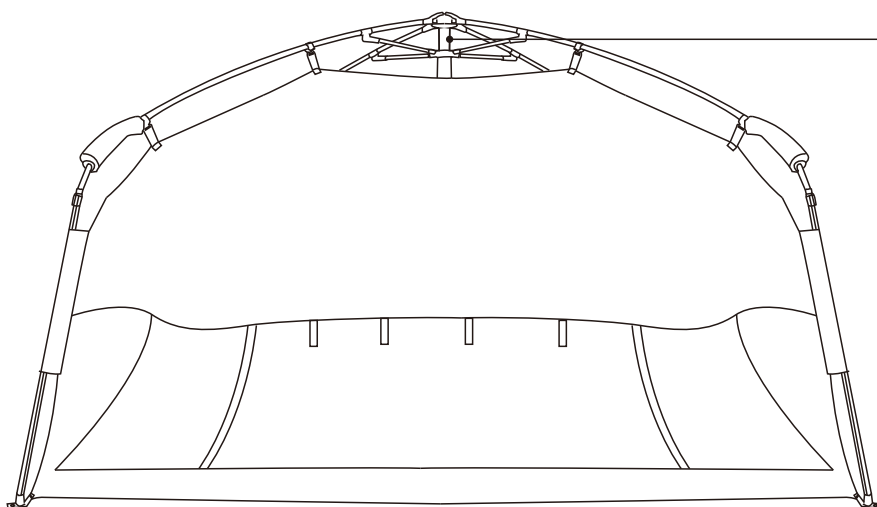

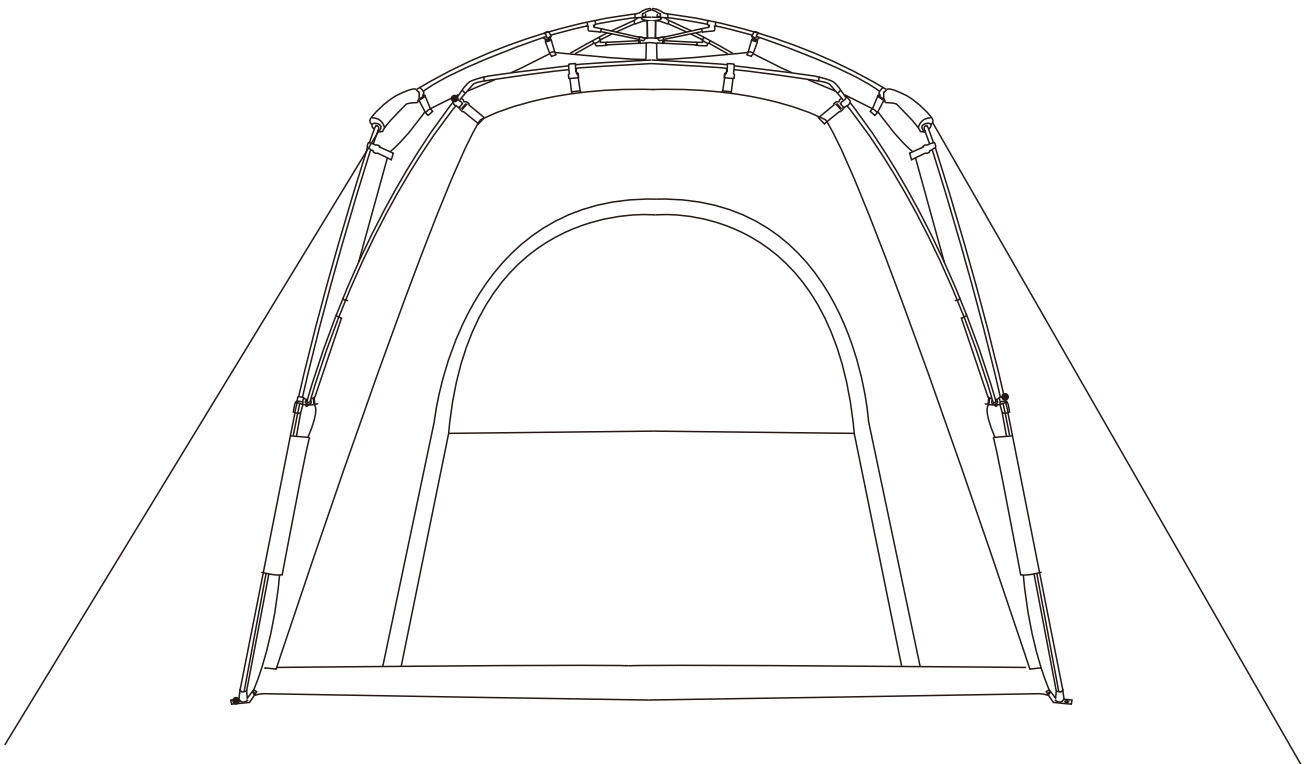
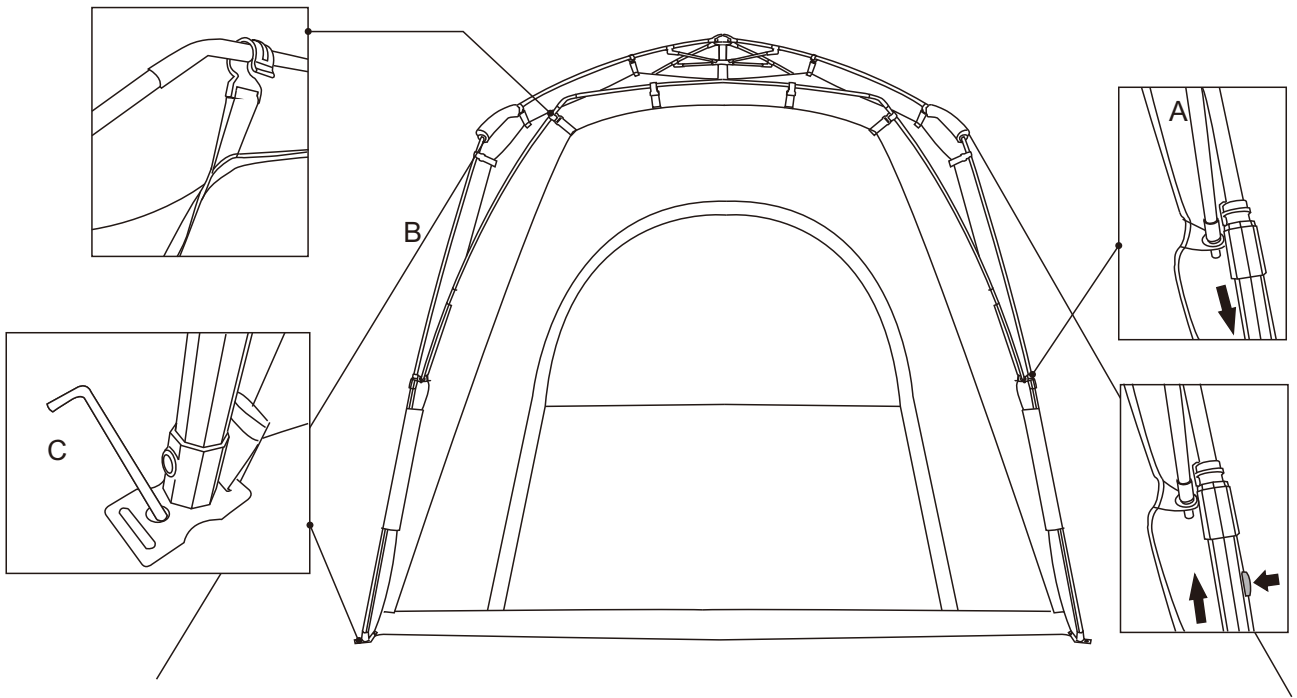

If you have any questions, please contact our customer care center, Our contact details are below:

US

 001-877-644-9366

 customerservice@aosom.com

Imported by Aosom LLC
27150 SW Kinsman Rd Wilsonville, OR 97070 USA
MADE IN CHINA

Wenn Sie Fragen haben, wenden Sie sich bitte an unser Kundendienstzentrum, Unsere Kontaktdaten stehen unten:

DE

 0049-0(40)-88307530

 service@aosom.de

ADRESSE DES IMPORTEURE/Hersteller/REP:
MH Handel GmbH
Wendenstraße 309
D-20537 Hamburg
Germany
IN CHINA HERGESTELLT

If you have any questions, please contact our customer care center, Our contact details are below:

CA

 416-792-6088

 customerservice@aosom.ca

Imported by Aosom Canada Inc.
7270 Woodbine Avenue, Unit 307, Markham,
Ontario Canada L3R 4B9
MADE IN CHINA

Si vous avez la moindre question, veuillez contacter notre centre d'assistance à la clientèle, Nos coordonnées sont les suivantes:

 416-792-6088

 customerservice@aosom.ca

Importé par Aosom Canada Inc.
7270 Woodbine Avenue, unité 307,
Markham, Ontario Canada L3R 4B9
FABRIQUÉ EN CHINE

In caso di dubbio, si prega di contattare il nostro centro assistenza clienti, I nostri dettagli di contatto sono di seguito:

IT

 0039-0249471447

 clienti@aosom.it

IMPORTATO DA/Produttore/REP:
AOSOM Italy srl
Centro Direzionale Milanofiori
Strada 1 Palazzo F1
20057 Assago (MI)
P.I.: 08567220960
FATTO IN CINA

Si tiene alguna pregunta, comuníquese con nuestro Centro de Atención al Cliente, Nuestros datos de contacto son los siguientes:

ES

 0034-931294512

 atencioncliente@aosom.es

IMPORTADOR/Fabricante/REP:
SPANISH AOSOM, S.L.
C/ROC GROS, N°15.08550, ELS HOSTALETES DE
BALENYÀ, SPAIN.
B66295775
HECHO EN CHINA

If you have any questions, please contact our customer care center, Our contact details are below:

UK

 0044-800-240-4004

 enquiries@mhstar.co.uk

IMPORTER ADDRESS:
MH STAR UK LTD
Unit 27, Perivale Park,
Horsenden lane South
Perivale, UB6 7RH
MADE IN CHINA

Se tiver alguma dúvida, por favor contacte o nosso Centro de Atendimento ao Cliente, Os nossos dados de contacto são os seguintes:

PT

 0034-931294512

 info@aosom.pt.

IMPORTADOR/Fabricante/REP:
SPANISH AOSOM, S.L.
C.ROC GROS N.15, 08550. ELS HOSTALETES DE
BALENYÀ
FEITO NA CHINA

Si vous avez la moindre question, veuillez contacter notre centre d'assistance à la clientèle, Nos coordonnées sont les suivantes:

FR

 0033-1-84166106

 aosom@mhfrance.fr

Importé par/Fabricant/REP:
MH FRANCE
2 Rue Maurice Hartmann
92130 Issy Les Moulineaux
France
FABRIQUÉ EN CHINE



FR

**DONNEZ
OU
RECYCLEZ**



ASSOCIATION

OU



LIVRAISON

OU



DÉCHÈTERIE

Adresses sur quefairedemesdechets.fr