

# Outsunny

IN231100524V03\_GL

**863-150V00**

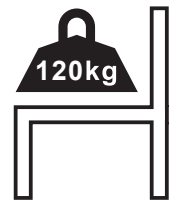
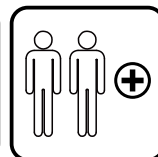
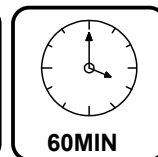
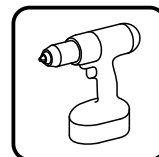
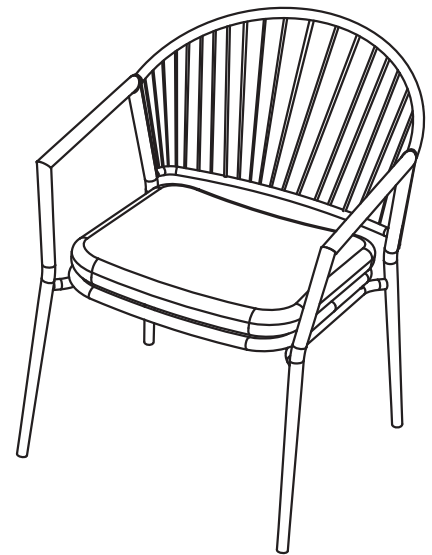
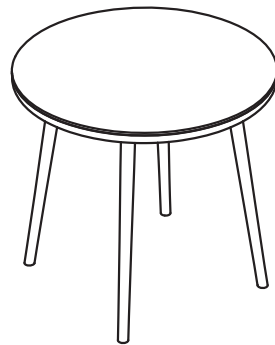
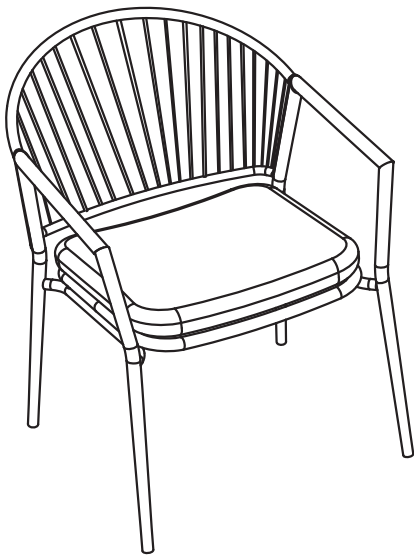

**EN\_ IMPORTANT, RETAIN FOR FUTURE REFERENCE: READ CAREFULLY.**

**FR\_ IMPORTANT: A LIRE ATTENTIVEMENT ET A CONSERVER POUR VOUS Y REFRERER ULTERIEUREMENT.**

**ES\_ IMPORTANTE, LEA DETENIDAMENTE Y GUARDE PARA FUTURAS REFERENCIAS.**

**PT\_ IMPORTANTE, GUARDE PARA FUTURA REFERÊNCIA, LEIA ATENTAMENTE.**

**DE\_ WICHTIG! SORGFÄLTIG LESEN UND FÜR SPÄTER NACHSCHLAGEN AUFBEWAHREN.**

**IT\_ IMPORTANTE, LEGGERE E CONSERVARE QUESTO MANUALE D'ISTRUZIONE PER UN USO FUTURO.**

# **IMPORTANT, RETAIN FOR FUTURE REFERENCE: READ CAREFULLY.**

## **Only for domestic use**

### **Use tips:**

- \*Put the chair stably on a flat floor.
- \*Mount the garden chairs in the shelter of the weather.
- \*Stay away from open flames.
- \*Don't hang anything in the structure.
- \*Avoid the overload at the anchors/structure.
- \*It is advised that don't stay on the chairs when there is a storm.
- \*Do not use in adverse weather condition and cover furniture when not in use.

### **Precautions before assembly:**

- \*Prepare a clean and dry mounting area.
- \*Verify that the product is not damaged.
- \*Check that none of the pieces are missing.

### **Maintenance:**

- \*Clean with a soft fabric.
- \*Regularly remove leaves and / or water collected on the canvas.
- \*Check the chair regularly.

### **Storage conditions:**

- \*The fabric should be stored completely dry, in a clean and dry place to avoid the risks of mold.

### **Maintenance:**

\*Don't use this product if the seat cloths, cloth cushion or tarpaulins are ageing, and contact our customer service.

### **Caution with the risks of pinching or cuts during assembly.**

**The manufacturer declines all responsibility in case of damages due to a bad installation or due to weather.**

# **IMPORTANT: A LIRE ATTENTIVEMENT ET À CONSERVER POUR CONSULTATION ULTÉRIEURE.**

## **Seulement pour usage domestique**

### **Conseils:**

- \* Pour une performance optimale, veuillez le poser sur une surface plane.
- \* Installer la chaise sous l'auvent.
- \* Maintenez à l'écart de toute flamme nue.
- \* Évitez de suspendre des matériaux sur le meuble.
- \* Veuillez à ne pas dépasser les capacités de poids maximales.
- \* Il est conseillé de ne pas rester sur la chaise en cas d'orage.
- \* Ne pas utiliser dans des conditions météorologiques défavorables et couvrir les meubles lorsqu'ils ne sont pas utilisés.

### **Précautions avant l'assemblage:**

- \* Préparez une zone de montage propre et sèche.
- \* Vérifiez que le produit n'est pas endommagé.
- \* Vérifiez qu'aucun des morceaux ne manque.

### **Recommandations d'entretien:**

- \* Veuillez utiliser un chiffon doux pour essuyer la chaise.
- \* Veuillez nettoyer régulièrement l'eau stagnante du fauteuil
- \* Veuillez vérifier régulièrement la chaise pour éviter une structure lâche.

### **Conditions de stockage:**

- \* Lorsqu'ils ne sont pas utilisés, les meubles doivent être recouverts d'une housse appropriée.

### **Entretien:**

- \* Si vous remarquez une détérioration du tissu du siège, du coussin en tissu ou de la bâche, ne l'utilisez pas, contactez notre service clientèle immédiatement.

**Veuillez faire attention à ne pas vous blesser lors de l'assemblage du produit.**

**Le fabricant n'est pas responsable des dommages causés par une mauvaise installation.**

# IMPORTANTE, LEA Y GUARDE PARA FUTURAS REFERENCIAS.

## **Solamente para uso doméstico**

### **Consejos de uso:**

- \*Coloque el balancín de forma estable sobre un suelo plano.
- \*Monte las sillas de jardín en el toldo.
- \*Manténgase alejado de llamas abiertas.
- \*No cuelgue nada en la estructura.
- \*Envíe la sobrecarga en los anclajes.
- \*Se aconseja no permanecer en el balancín cuando hay tormenta.
- \*Se recomienda resguardar en caso de viento o lluvia fuerte y en su ausencia.

### **Precauciones antes del montaje:**

- \*Prepare una zona de montaje limpia y seca.
- \*Verificar que el producto no este dañado.
- \*Controlar que no falta ninguna de las piezas.

### **Mantenimiento:**

- \*Limpiar con la ayuda de un paño suave.
- \*Eliminar regularmente las hojas y/o agua recogidas sobre la lona.
- \*Inspeccione las sillas regularmente.

### **Condiciones de almacenaje:**

- \*La tela debe ser guardada totalmente seca, en un lugar limpio y seco para evitar los riesgos de moho.

### **Mantenimiento:**

\*No utilice este producto si la tela del asiento, el cojín de tela o la lona alquitranada están envejeciendo, comuníquese con nuestro servicio de atención al cliente a tiempo.

**Precaución con los riesgos de pinzamientos o cortes durante el montaje. El fabricante declina toda responsabilidad en caso de deterioros debidos a una mala instalación o por causas meteorológicas.**

# **IMPORTANTE, RETER PARA REFERÊNCIA FUTURA: LEIA ATENTAMENTE.**

## **Produto para uso em doméstico**

### **Conselhos de uso:**

- \* Coloque o produto sobre um solo plano e estável.
- \* Monte as cadeiras sobre um toldo.
- \* Mantenha-o afastado de fontes de calor e chamas.
- \* Evite a sobre carga das fixações do produto.
- \* Guarde em caso de vento ou chuva forte.

### **Precauções antes da montagem:**

- \* Prepare a zona de montagem. Certifique-se de que esteja limpa e seca.
- \* Certifique-se que o produto esteja em bom estado.
- \* Verifique que não falte nenhuma das peças.

### **Manutenção:**

- \* Limpar o produto com a ajuda de um pano suave.
- \* Inspeccionar o produto de forma regular a fim de detectar possíveis defeitos que possa afetar seu uso.

### **Condições de armazenamento:**

- \* A fim de evitar a aparecimento de mofo, os tecidos se devem guardar totalmente secos e em um lugar limpo e sem umidade.

### **Manutenção:**

- \* Não utilize este produto se os panos de assento, almofadas de pano ou lonas estiverem a envelhecer, e contacte o nosso serviço ao cliente.

### **Atenção:**

**Risco de cortes durante a montagem. O fabricante declina toda responsabilidade no caso de deterioração devido uma má instalação ou por causas meteorológicas.**

**Se o produto estiver equipado com algum mecanismo elétrico de ajuste de altura ou similar, somente poderá ser substituído ou reparado por uma pessoa qualificada ou técnicos.**

# WICHTIG! SORGFÄLTIG LESEN UND FÜR SPÄTER NACHSCHLAGEN AUFBEWAHREN.

## Nur für den häuslichen Gebrauch bestimmt

### Nutzungshinweise:

- \* Optimale Leistung bitte auf eine ebene Fläche stellen.
- \* Installieren Sie den Stuhl unter der Markise.
- \* Von offenen Flammen fernhalten.
- \* Vermeiden Sie jegliche hängenden Materialien an den Möbeln.
- \* Bitte überschreiten Sie nicht die maximalen Gewichtskapazitäten.
- \* Es wird empfohlen, die Schaukel bei schlechten Wetterbedingungen nicht zu benutzen.
- \* Verwendung nicht bei schlechtem Wetter und decken Sie die Möbel ab, wenn sie nicht in Verwendung sind.

### Vorsichtsmaßnahmen vor der Montage:

- \* Bitte bereiten Sie einen sauberen und trockenen Montagebereich vor.
- \* Stellen Sie sicher, dass das Produkt nicht beschädigt ist.
- \* Vergewissern Sie sich, dass keines der Zubehöerteile fehlt.

### Instandhaltung:

- \* Bitte reinigen Sie die Schaukel nur mit einem weichen Tuch.
- \* Bitte entfernen Sie regelmäßig alle Blätter und / oder Wasser, die sich auf dem Stoff angesammelt haben.
- \* Überprüfen Sie die Gartenstühle regelmässig.

### Lagerung:

- \* Bei Nichtverwendung sollten die Möbel mit einer geeigneten Möbelabdeckung abgedeckt werden.

### Wartung:

\* Verwenden Sie dieses Produkt nicht, wenn die Sitztücher, das Stoffkissen oder die Planen gealtert sind, und wenden Sie sich an unseren Kundendienst.

### Vorsicht vor Quetsch- und Schnittgefahr bei der Montage.

**Der Hersteller lehnt jede Haftung für Schäden ab, die durch unsachgemäße Installation oder Witterungseinflüsse verursacht wurden.**

# **IMPORTANTE! CONSERVARE IL PRESENTE MANUALE PER FUTURO RIFERIMENTO E LEggerLO ATTENTAMENTE.**

## **Solo per uso domestico**

### **Consigli per l'uso:**

- \*Per le prestazioni ottimali, si prega di posizionarli sulla superficie piana.
- \*Installare la sedia sotto la tenda da sole.
- \*Tenere lontano da qualsiasi fiamme libere.
- \*Evitare di appendere qualsiasi materiale sui mobili.
- \*Non superare le capacità massime di peso.
- \*E' consigliabile di non utilizzare l'altalena quando fuori c'e' un temporale.
- \*Non utilizzare nel maltempo e si prega di coprire i mobili quando non sono in uso.

### **Precauzioni prima del montaggio:**

- \*Preparare un'area di assemblaggio pulita e asciutta.
- \*Verificare che il prodotto non sia danneggiato.
- \*Controllare che nessun pezzo manchi.

### **Manutenzione:**

- \*Pulire con un panno morbido.
- \*Rimuovere regolarmente foglie e / o acqua depositata sul telo.
- \*Controllare le sedie regolarmente.

### **Condizioni per il deposito:**

- \*Il tessuto va riposto completamente asciutto in un luogo asciutto e pulito per evitare i rischi di muffa.

### **Manutenzione:**

\*Non utilizzare questo prodotto in caso che i tessuti del sedile, il cuscino in tessuto o i teloni si stanno invecchiando e contatta in tempo il nostro servizio clienti.

**Cautela causa rischio di tagli o pizzicamenti durante l'assemblaggio.**

**Il produttore declina ogni responsabilita' in caso di lesioni derivanti da montaggio inaccurato o dalle condizioni metereologiche.**

## PARTS

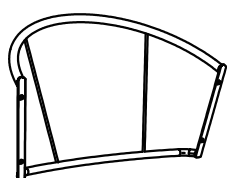

A x2

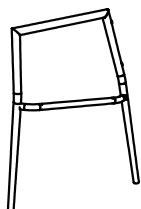

B x2

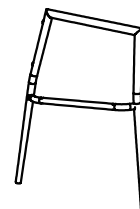

C x2

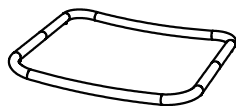

D x2

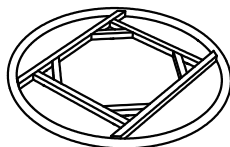

E x1



F x4



G x1



M x2

## HARDWARE

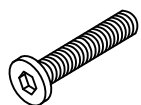
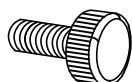
H x20  
M6\*15  
+1(spare)I x8  
M6\*35  
+1(spare)J x28  
+1(spare)

K x12



L x1

**EN** Do not confuse similar screws. Do not tighten bolts fully until all parts are connected!  
**FR** Ne pas confondre des vis similaires. Ne serrez pas les boulons à fond tant que toutes les pièces ne sont pas connectées!

**ES** No confunda tornillos similares. No apriete los tornillos completamente hasta que todas las partes están conectadas!

**PT** Não confundir parafusos semelhantes. Não apertar completamente os parafusos até que todas as peças estejam encaixadas!

**DE** Verwechseln Sie ähnliche Schrauben nicht. Ziehen Sie die Schrauben erst fest an, wenn alle Teile verbunden sind!

**IT** Non confondere le viti simili. non serrare completamente i bulloni fino a tutte le parti non sono ancora collegate!

## NOTE

A x 1

B x 1

C x 1

H x 4

J x 4

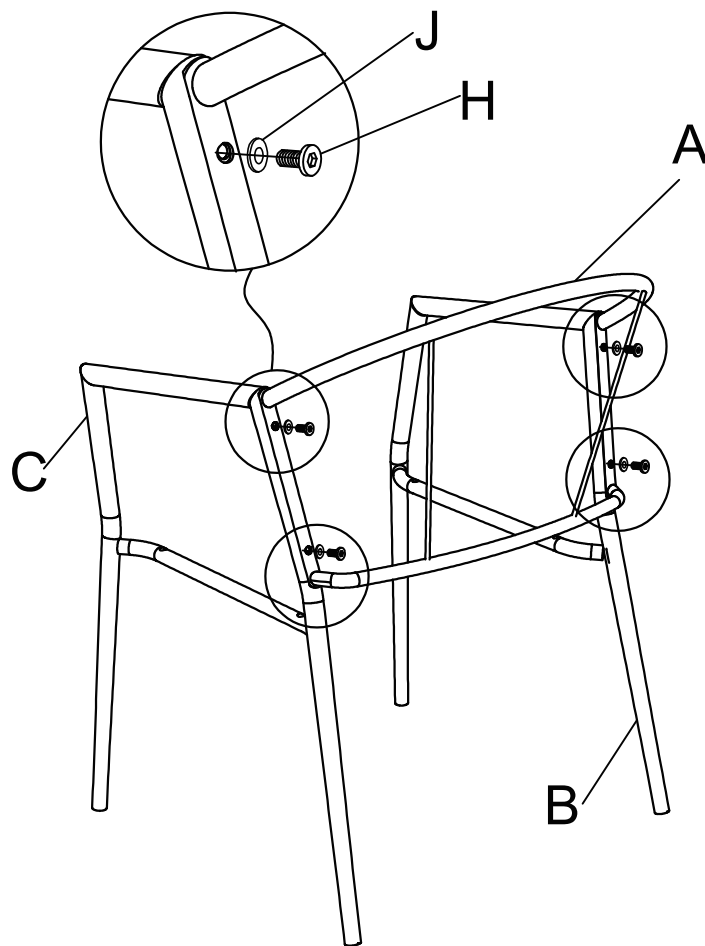

D x 1

I x 4

J x 4

K x 4

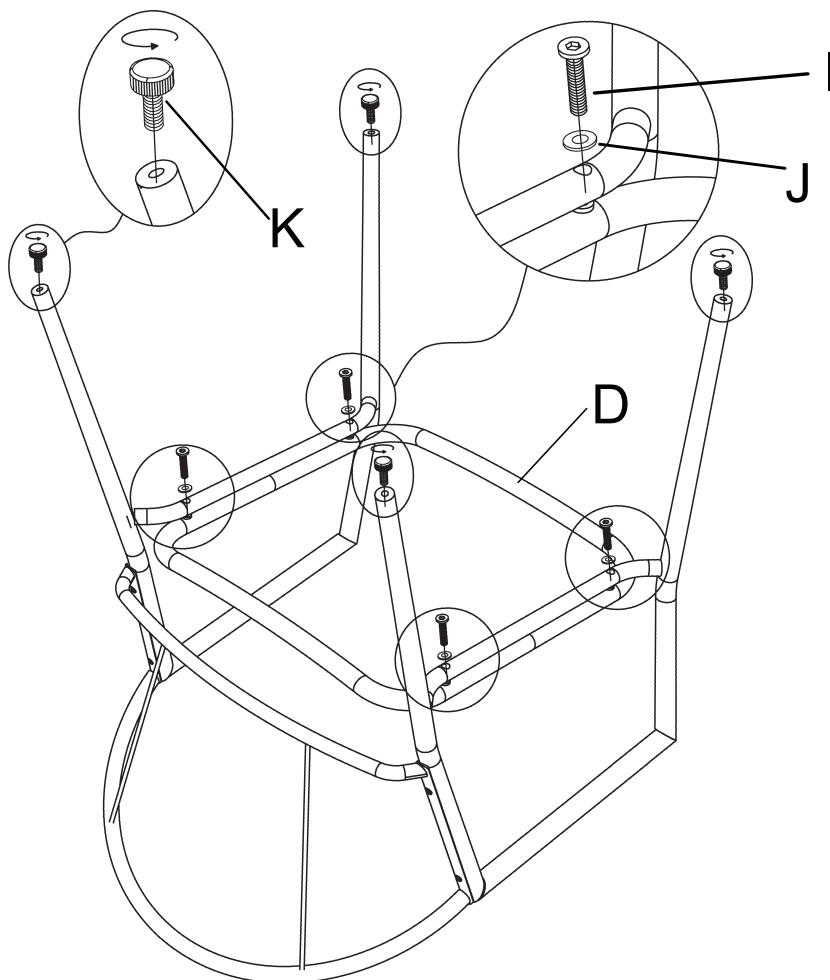

E x 1

F x 4

H x 12

J x 12

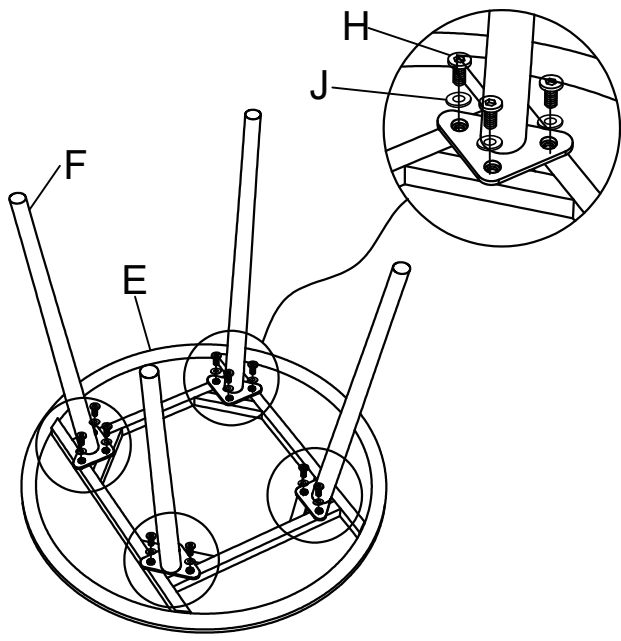

K x 4

G x 1

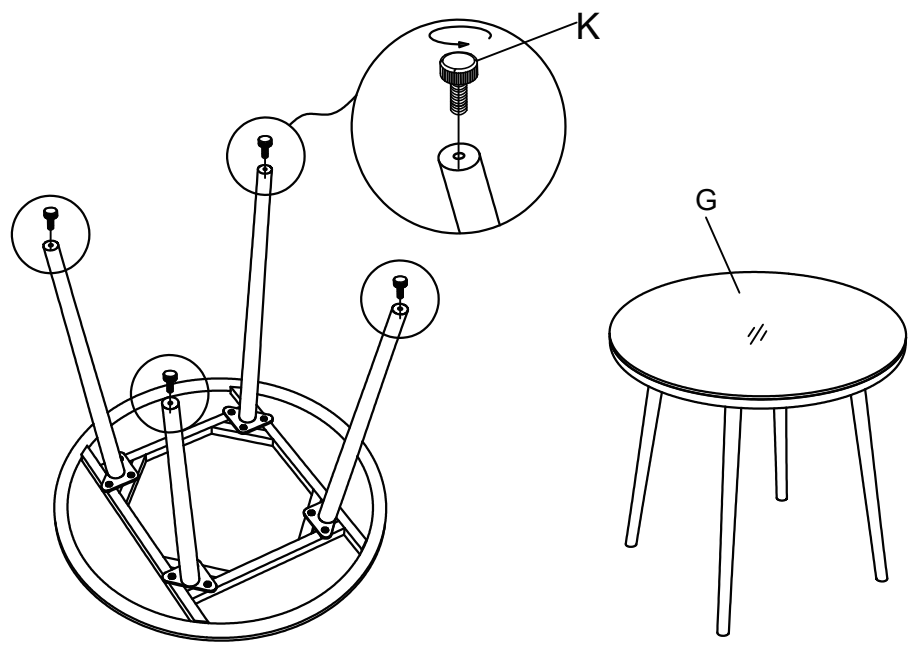

M x 2

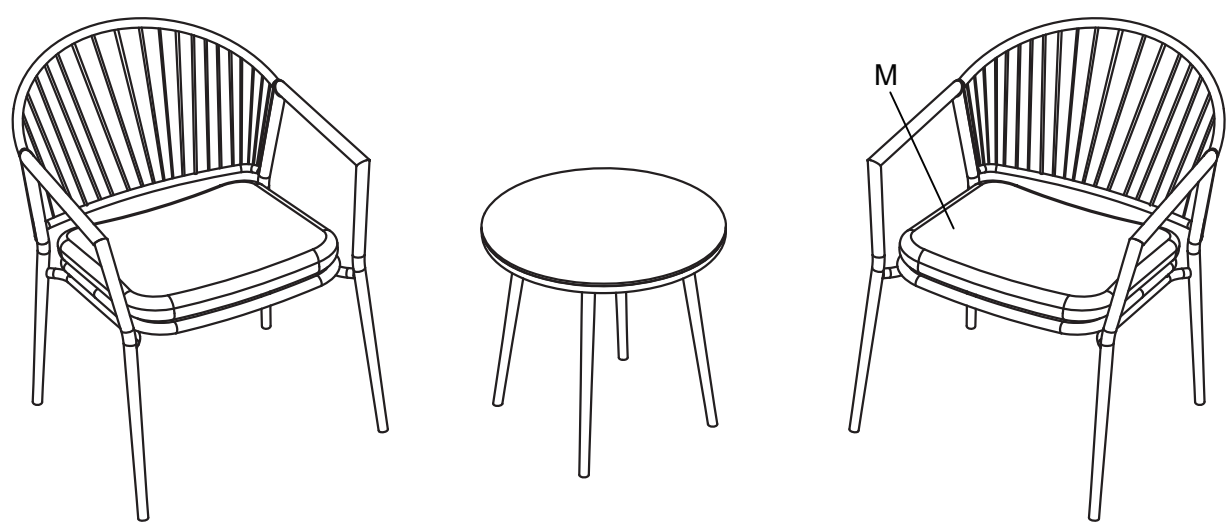

If you have any questions, please contact our customer care center, Our contact details are below:

**US**

 001-877-644-9366

 customerservice@aosom.com

Imported by Aosom LLC  
27150 SW Kinsman Rd Wilsonville, OR 97070 USA  
MADE IN CHINA

If you have any questions, please contact our customer care center, Our contact details are below:

**UK**

 0044-800-240-4004

 enquiries@mhstar.co.uk

IMPORTER ADDRESS:  
MH STAR UK LTD  
Unit 27, Perivale Park,  
Horsenden lane South  
Perivale, UB6 7RH  
MADE IN CHINA

If you have any questions, please contact our customer care center, Our contact details are below:

**CA**

Si vous avez la moindre question, veuillez contacter notre centre d'assistance à la clientèle, Nos coordonnées sont les suivantes:

 416-792-6088

 customerservice@aosom.ca

Imported by Aosom Canada Inc.  
7270 Woodbine Avenue, Unit 307, Markham,  
Ontario Canada L3R 4B9  
MADE IN CHINA

Importé par Aosom Canada Inc.  
7270 Woodbine Avenue, unité 307, Markham,  
Ontario Canada L3R 4B9  
FABRIQUÉ EN CHINE

Wenn Sie Fragen haben, wenden Sie sich bitte an unser Kundendienstzentrum, Unsere Kontaktdaten stehen unten:

**DE**

 0049-0(40)-88307530

 service@aosom.de

ADRESSE DES IMPORTEUR/Hersteller/REP:  
MH Handel GmbH Wendenstraße 309 D-20537  
Hamburg  
Germany  
IN CHINA HERGESTELLT

In caso di dubbio, si prega di contattare il nostro centro assistenza clienti, I nostri dettagli di contatto sono di seguito:

**IT**

 0039-0249471447

 clienti@aosom.it

IMPORTATO DA/Produttore/REP: AOSOM Italy srl  
Centro Direzionale Milanofiori Strada 1 Palazzo F1  
20057 Assago (MI)  
P.I.: 08567220960  
FATTO IN CINA

Si tiene alguna pregunta, comuníquese con nuestro Centro de Atención al Cliente, Nuestros datos de contacto son los siguientes:

**ES**

 0034-931294512

 atencioncliente@aosom.es

IMPORTADOR/Fabricante/REP:  
SPANISH AOSOM, S.L.  
C/ROC GROS, Nº15.08550, ELS HOSTALET DE  
BALENYÀ, SPAIN.  
B66295775  
HECHO EN CHINA

Se tiver alguma dúvida, por favor contacte o nosso Centro de Atendimento ao Cliente, Os nossos dados de contacto são os seguintes:

**PT**

 0034-931294512

 info@aosom.pt.

IMPORTADOR/Fabricante/REP: SPANISH  
AOSOM, S.L C.ROC GROS N.15, 08550. ELS  
HOSTALET DE BALENYÀ  
FEITO NA CHINA

Si vous avez la moindre question, veuillez contacter notre centre d'assistance à la clientèle, Nos coordonnées sont les suivantes:

**FR**

 0033-1-84166106  aosom@mhfrance.fr

Importé par/Fabricant/REP: MH FRANCE 2 Rue Maurice Hartmann 92130 Issy Les Moulinaux  
France  
FABRIQUÉ EN CHINE



**FR**

**DONNEZ  
OU  
RECYCLEZ**



OU



OU



ASSOCIATION

LIVRAISON

DÉCHÈTERIE

Adresses sur [quefairedemesdechets.fr](http://quefairedemesdechets.fr)