



**CAUTION:**

- This package contains small parts which are for adult assembly only.
- Care should be taken when unpacking and assembling toy.



**WARNING**

Adult Assembly Required

**IMPORTANT, RETAIN FOR FUTURE REFERENCE: READ CAREFULLY**

**ASSEMBLY INSTRUCTION**

## **Warning:**







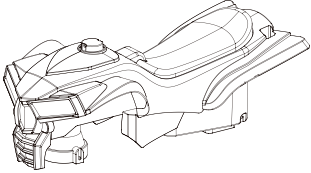

1. The Ride-On car is designed for children aged 12-36 months. The rider's weight must not exceed 25kg (55lbs).
2. The product is designed to only seat 1 child at a time to avoid injuries.
3. Parental guidance and supervision are strongly advised.
4. To ensure safety, all parts of the product must be assembled by an adult.
5. Avoid going near streets, crossroads, traffic areas, swimming pools and stairs when riding the car.
6. Check the product regularly to make sure everything is secure.  
In particular, the nut and bolt on the steering wheel must be tightened.
7. Dangers may occur if the product is not correctly assembled.
8. Shoes must be worn.

## **Battery Handling:**

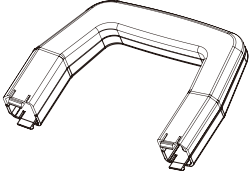
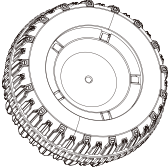
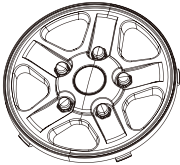
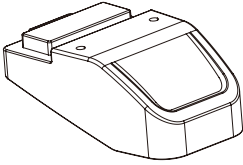
1. Battery must be handled by adults only.
2. Always remove exhausted batteries.
3. Use 2 x AA size batteries (not included) to make the lights and sound work.
4. Alkaline batteries are recommended.
5. Always remove batteries when the unit is not going to be used for an extended period of time.
6. When batteries need replacing, make sure to replace all of them at the same time.
7. Do not mix old and new batteries.
8. Do not mix different types of batteries (Alkaline Standard, Carbon-Zinc and Nickel-Cadmium).
9. Do not dispose of batteries in fire, they may explode or leak.

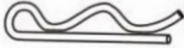
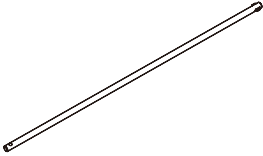
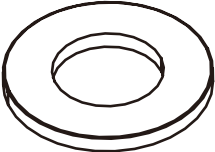
# ASSEMBLY INSTRUCTIONS

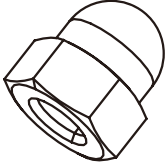
## COMPONENTS LIST

1. Car body×1		2. Handle×1	
3. Backrest ×1		4. Wheel×4	
5. Wheel cap×4		6. Anti-tumble shelf×1	
7. Plastic ring ×4		8. Cotter Pin×2	
9. Axle ×2		10. Washer ×4	
11. Bolt×1		12. Nut×1	
13. Screw ×2			

< Step 1 >

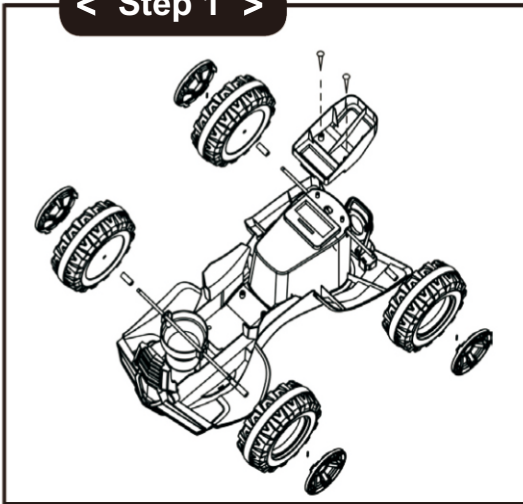

**How to assemble the wheels :**

- Insert the axle through plastic rings into the main body of the car, tightening using a cotter pin.
- Assemble the four wheel caps.

**How to assemble the anti-tumble shelf:**

- Place the anti-tumble shelf into the rear of the body.
- Assemble the two screws with a screwdriver.

< Step 2 >



**How to assemble the handle:**

- Place the handle.
- Insert the bolt into the hole and tighten with a screwdriver.

**How to assemble the toddler bar:**

- Place the toddler bar over the holes in the rear of the product.
- While holding the front of the vehicle down, push firmly on the toddler bar so that it fits into the holes. Ensure the toddler bar is properly fitted.

**BATTERY CHANGE**

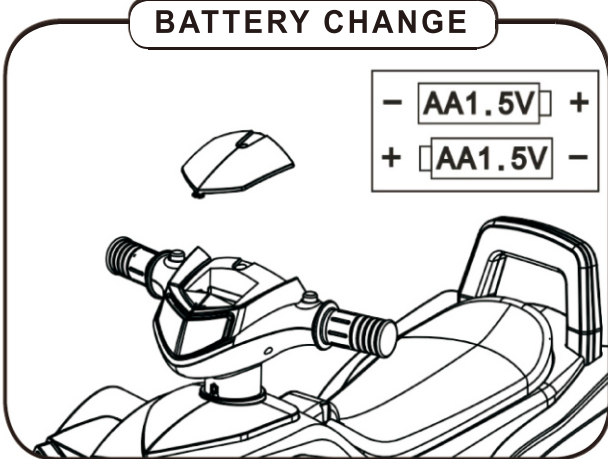

**How to change the battery:**

- Loosen the screw with a screwdriver.
- Keep the screw in a safe place away from children's reach.
- Put 2AA batteries in the battery house.
- Press the buttons on the handle to check the batteries are functioning and to make sure the revving engine, the horn and the blinking lights are properly activated, before securing the screws."

**AVERTISSEMENT:**

- Ce paquet contient de petites pièces qui sont destinées à un montage adulte uniquement.
- Des précautions doivent être prises lors du déballage et du montage du jouet.

**ATTENTION**

Assemblage adulte requis.

**IMPORTANT : LIRE ATTENTIVEMENT ET CONSERVEZ CE MANUEL POUR VOUS Y REFERER ULTERIEUREMENT.**

# Assemblage & manuel d'instructions

## **ATTENTION:**







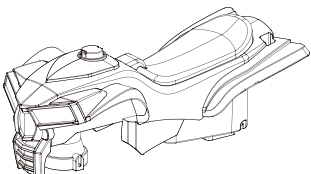

- 1-La voiture Ride-On est conçue pour les enfants âgés de 12-36 mois. Le poids du cycliste ne doit pas dépasser 25 kg (55 lb).
- 2-Le produit est conçu pour n'asseoir qu'un enfant à la fois afin d'éviter les blessures.
- 3-L'orientation et la surveillance parentales sont fortement conseillées.
- 4-Pour assurer la sécurité, toutes les pièces du produit doivent être assemblées par un adulte.
- 5-Évitez de vous approcher des rues, des carrefours, des zones de circulation, des piscines et des escaliers lorsque vous conduisez la voiture.
- 6-Vérifiez régulièrement le produit pour vous assurer que tout est sécurisé. En particulier, l'écrou et le boulon sur le volant doivent être serrés.
- 7-Des dangers peuvent survenir si le produit n'est pas correctement assemblé.
- 8-Des chaussures doivent être portées.

## **Manipulation de la batterie:**

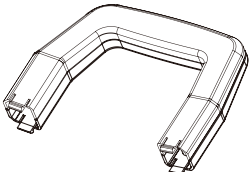
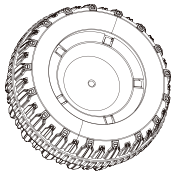
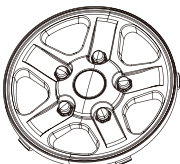
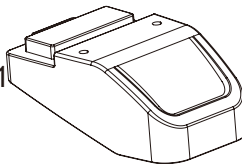
- 1-La batterie doit être manipulée uniquement par des adultes.
- 2-Retirez toujours les piles épuisées.
- 3-Veuillez utiliser 2 batteries AA (non incluses) pour faire marcher les lumières et le s sons.
- 4-Piles alcalines sont recommandées.
- 5-Retirez toujours les piles lorsque l'appareil ne sera pas utilisé pendant une période prolongée.
- 6-Lors du remplacement de piles neuves, remplacez toujours toutes les piles.
- 7-Ne mélangez pas les anciennes et les nouvelles piles.
- 8-Ne mélangez pas les piles alcalines, standard (carbone-zinc) ou rechargeables (piles au nickel-cadmium).
- 9-Ne jetez pas les batteries au feu, les batteries peuvent exploser ou fuir.

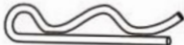
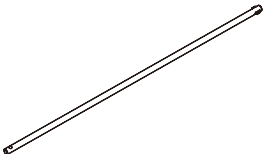
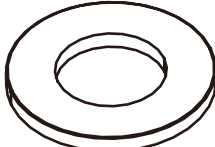
# INSTRUCTIONS DE MONTAGE

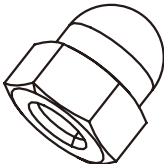
## LISTE DES COMPOSANTS

1. Carrosserie x 1		2. poignée x 1	
3. repos arrière x 1		4. Roue x 4	
5. Capuchon de roue x 4		6. Étagère anti-culbutage x 1	
7. Bague en plastique x 4		8. CotterPin x 2	
9. Essieu x 2		10. Rondelle x 4	
11. Boulon x 1		12. Écrou x 1	
13. Vis x 2			



FR

Cet appareil,  
ses accessoires,  
cordons et batteries  
se recyclent

REPRISE  
À LA LIVRAISON



ou

À DÉPOSER  
EN MAGASIN



ou

À DÉPOSER  
EN DÉCHÈTERIE



Points de collecte sur [www.quefairedemesdechets.fr](http://www.quefairedemesdechets.fr)  
Privilégiez la réparation ou le don de votre appareil !

### < Étape 1 >

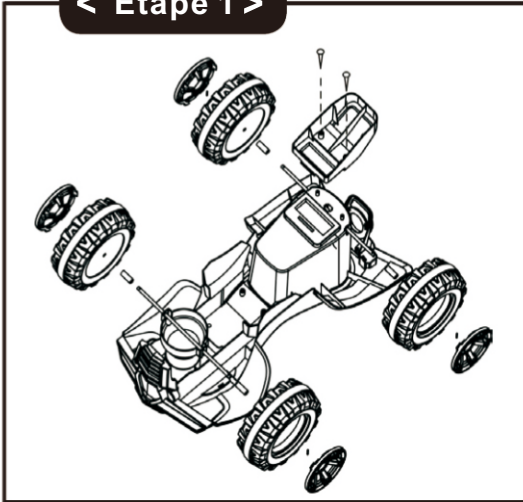

#### Comment assembler les roues:

- Insérez l'essieu à travers des anneaux en plastique dans le corps principal de la voiture, serrez à l'aide d'une goupille fendue.
- Assemblez les quatre enjoliveurs.

#### Comment assembler la tablette anti-culbute:

- Placez la tablette anti-culbute à l'arrière du corps.
- Assemblez les deux vis avec un tournevis.

### < Étape 2 >



#### Comment assembler la poignée:

- Placez la poignée.
- Insérez le boulon dans le trou et serrez avec un tournevis.

#### Comment assembler la barre pour tout-petits:

- Placez la barre pour tout-petits sur les trous à l'arrière du produit.
- Tout en maintenant l'avant du véhicule enfoncé, appuyez fermement sur la barre pour tout-petits afin qu'elle s'insère dans les trous. Assurez-vous que la barre pour tout-petits est correctement installée.

### CHANGEMENT DE BATTERIE

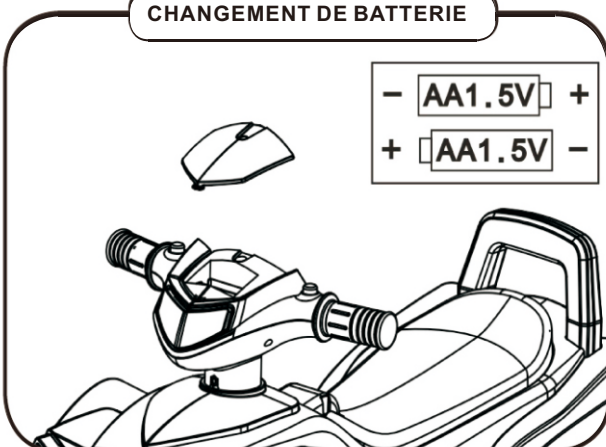

#### Comment échanger la batterie.

- Desserrez les vis avec un tournevis.
- Gardez les vis dans un endroit sûr, hors de la portée des enfants.
- Mettez 2 piles AA dans le logement des piles.
- Appuyez sur les boutons de la poignée pour vérifier que les piles fonctionnent et pour vous assurer que le moteur, le klaxon et les feux clignotants sont correctement activés, avant de serrer les vis.

**ACHTUNG:**

- Dieses Paket enthält Kleinteile, die nur für den Zusammenbau durch Erwachsene bestimmt sind.
- Beim Auspacken und Zusammenbau von Spielzeug ist Vorsicht geboten.

**ACHTUNG**

Montage durch einen Erwachsenen erforderlich

**WICHTIG, FÜR DIE SPÄTERE VERWENDUNG AUFBEWAHREN:  
SORGFÄLTIG DURCHLESEN**

# MONTAGEANWEISUNGEN

# **ACHTUNG:**







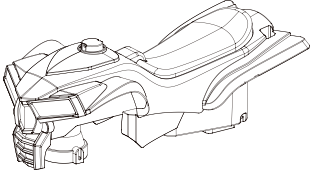

1. Dieses Spielzeugauto ist für Kinder im Alter von 12-36 Monaten. Das Gewicht des Fahrers darf 25 kg (55lbs) nicht überschreiten.
2. Dieses Produkt ist so gebaut, dass jeweils nur 1 Kind auf einmal darauf sitzen kann, um Verletzungen zu vermeiden.
3. Elterliche Anleitung und Aufsicht werden dringend empfohlen.
4. Um die Sicherheit zu gewährleisten, müssen alle Teile des Produkts von einem Erwachsenen zusammengebaut werden.
5. Bitte vermeiden Sie beim Fahren mit dem Spielzeugauto die Nähe von Straßen, Kreuzungen, Verkehrsflächen, Schwimmbädern und Treppen.
6. Bitte überprüfen Sie das Produkt regelmäßig, um sicherzustellen, dass alles ordnungsgemäß gesichert ist. Insbesondere müssen Mutter und Schraube am Lenkrad festgezogen werden.
7. Es können Gefahren auftreten, wenn das Produkt nicht korrekt montiert ist.
8. Die Schuhe müssen getragen werden.

# **Batteriehandhabung:**

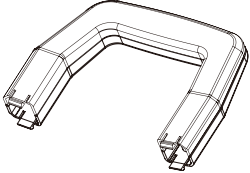
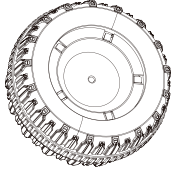
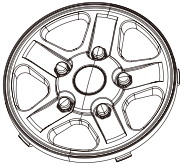
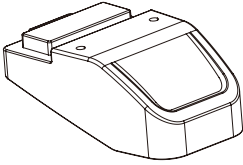
- 1- Batterien dürfen nur von Erwachsenen gehandhabt werden.
- 2- Entfernen Sie verbrauchte Batterien immer.
- 3- Bitte benutzen Sie 2x AA Batterien (nicht im Lieferumfang enthalten), damit das Licht und der Ton funktionieren.
- 4- Die Verwendung von Alkaline-Batterien wird empfohlen.
- 5- Bitte entfernen Sie die Batterien immer, wenn das Gerät über einen längeren Zeitraum nicht benutzt wird.
- 6- Ersetzen Sie beim Austausch neuer Batterien immer alle Batterien.
- 7- Bitte alte und neue Batterien nicht mischen.
- 8- Bitte mischen Sie keine Alkali-, Standard- (Kohlenstoff-Zink) oder wiederaufladbaren (Nickel-Cadmium-Batterien).
- 9- Bitte entsorgen Sie Batterien nicht im Feuer, Batterien können explodieren oder auslaufen.

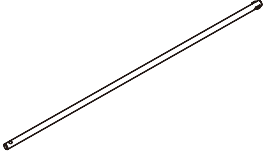
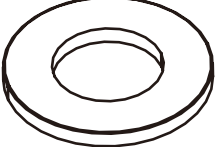
# MONTAGEANLEITUNG

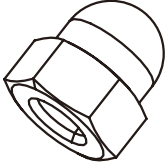
## BAUTEILLISTE

1. Fahrzeugkarosserie X1		2. Lenker x 1	
3. Rückenlehne x 1		4. Rad x 4	
5. Radkappe x 4		6. Abrollsicherung x 1	
7. Kunststoffring x 4		8. Federstecker x 2	
9. Achse x 2		10. Unterlegscheibe x 4	
11. Bolzen x 1		12. Mutter x 1	
13. Schraube x 2			

### < Schritt 1 >

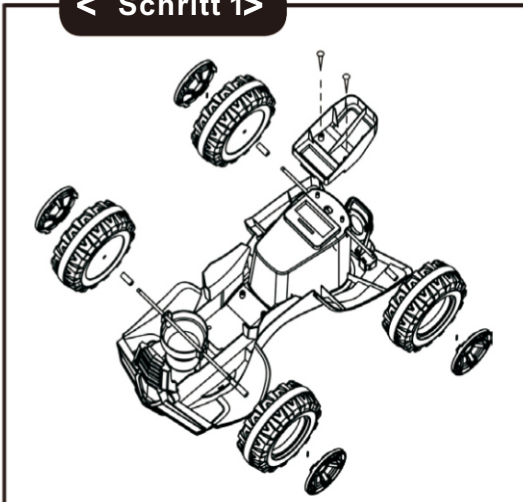

#### Montage der Räder:

- Bitte führen Sie die Achse durch Kunststoffringe in den Hauptkörper des Wagens ein, ziehen Sie sie mit einem Splint fest.
- Montieren Sie bitte die vier Radkappen.

#### So montieren Sie die Anti-Tumble-Ablage:

- Bitte legen Sie die Abrollsicherung in den hinteren Teil der Karosserie.
- Bitte montieren Sie die beiden Schrauben mit einem Schraubenzieher.

### < Schritt 2 >

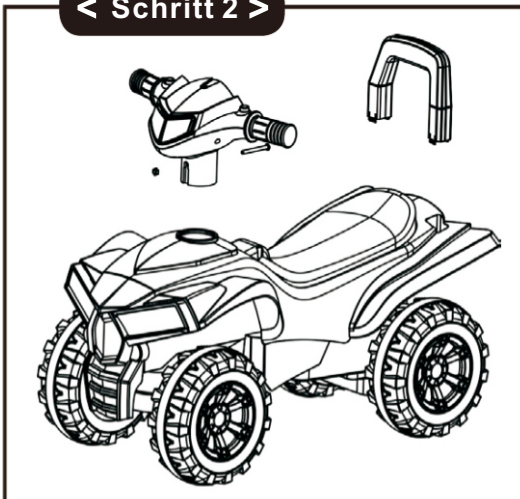

#### Montage der Lenkstange

- Bringen Sie die Lenkstange in die richtige Position
- Führen Sie den Bolzen in das Loch ein und ziehen Sie ihn mit einem Schraubenzieher fest.

#### Montage der Kleinkindstange

- Legen Sie die Kleinkindstange über die Löcher auf der Rückseite des Produkts.
- Halten Sie den vorderen Teil des Fahrzeugs unten und drücken Sie fest auf den Kleinkindstange, so dass diese in die Löcher passt. Vergewissern Sie sich, dass die Kleinkindstange richtig angebracht ist.

### BATTERIE WECHSEL

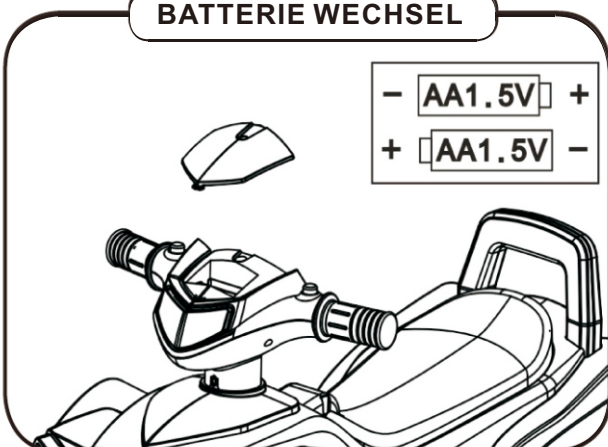

#### Wechseln der Batterie

- Lösen Sie die Schrauben mit einem Schraubenzieher.
- Bewahren Sie die Schrauben an einem sicheren Ort außerhalb der Reichweite von Kindern auf.
- Legen Sie 2AA-Batterien in das Batteriefach ein.
- Drücken Sie die Knöpfe am Griff, um die Funktion der Batterien zu prüfen und sicherzustellen, dass der Motor, die Hupe und die Blinklichter richtig aktiviert sind, bevor Sie die Schrauben befestigen.

**PRECAUCIÓN:**

- Este paquete contiene piezas pequeñas, lo que se requiere el montaje sólo por los adultos.
- Debe tener cuidado al desempacar y ensamblar el juguete.

**ADVERTENCIA**

Se requiere que se asamble por adultos sólo.

**IMPORTANTE, CONSERVAR PARA FUTURAS CONSULTAS:  
LEER DETENIDAMENTE.**

# INSTRUCCIONES DE MONTAJE

## **Advertencia:**







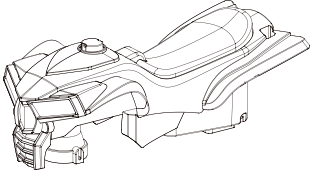

- 1- El auto (Ride-On Car) está diseñado para niños de 12 a 36 meses.. El peso del jinete no debe exceder 25 kg (55 lb).
- 2-El producto está diseñado para que se use por un/a niño/a a la vez con el motivo de evitar lesiones.
- 3-Recomendamos encarecidamente la orientación y supervisión de los padres.
- 4-Para garantizar la seguridad, todas las partes del producto deben ser ensambladas por un adulto.
- 5-Evite acercarse a las calles, cruces, áreas de tráfico, piscinas y escaleras al usar el auto.
- 6-Revise el producto regularmente para asegurarse de que todo esté seguro, especialmente la tuerca y el tornillo del volante deben estar apretados bien.
- 7-Pueden causar peligros si el producto no se ensambla de forma correcta.
- 8- Los zapatos deben ser usados al usar el producto.

## **Manejo de la batería:**

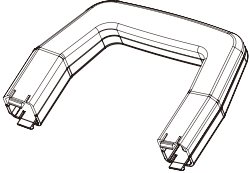
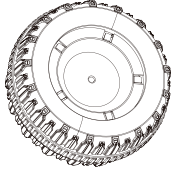
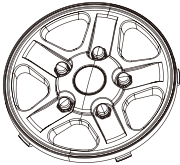
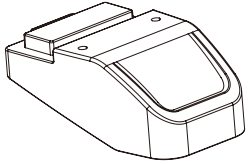
- 1-La batería sólo debe ser manejada por adultos.
- 2-Siempre retire las baterías agotadas.
- 3-Use 2 baterías de AA (no incluidas) para activar las luces y el sonido.
- 4-Recomendamos que use baterías alcalinas.
- 5-Siempre retire las baterías cuando el producto no se vaya a usar durante un período prolongado.
- 6-Cuando reemplace las baterías nuevas, reemplace siempre todas las baterías.
- 7-No mezcle las baterías viejas y nuevas.
- 8-No mezcle las baterías alcalinas, estándar (carbono-zinc) o recargables (baterías de níquel-cadmio).
- 9-No arroje las baterías al fuego, las baterías pueden explotar o causar fugas.

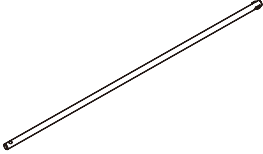
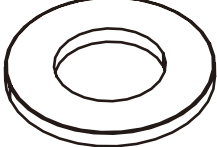
# INSTRUCCIONES DE MONTAJE

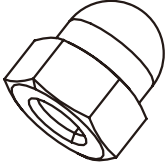
## LISTA DE COMPONENTES

1. Cuerpo del auto x 1		2. Manija Paso x 1	
3. Respaldo x 1		4. Rueda x 4	
5. Anillo de plástico x 4		6. Estante antivuelco x 1	
7. Anillo de plástico x 4		8. Pasador x 2	
9. Eje x 2		10. Arandela x 4	
11. Tornillo x 1		12. Tuerca x 1	
13. Tornillo x 2			

< Paso 1 >

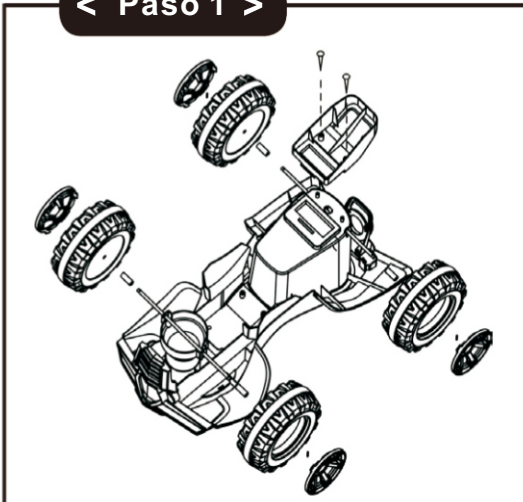

**Cómo ensamblar las ruedas:**

- Inserte el eje a través de anillos de plástico en el cuerpo principal del auto, apriete el eje con un pasador.
- Monte las 4 tapas de las ruedas.

**Cómo ensamblar el estante antivuelco:**

- Coloque el estante antivuelco en la parte posterior del cuerpo del auto.
- Ensamble los 2 tornillos con un destornillador.

< Paso 2 >



**Cómo ensamblar la manija:**

- Coloque la manija.
- Inserte el perno en el orificio y apriete el perno con un destornillador.

**Cómo ensamblar la barra para niños:**

- Coloque la barra para niños pequeños sobre los agujeros en la parte posterior de auto.
- Mientras mantenga presionando la parte delantera del auto, presione firmemente la barra para niños para que encaje en los agujeros. Asegúrese de que la barra para niños esté ajustada firmemente.

CAMBIO DE BATERÍAS

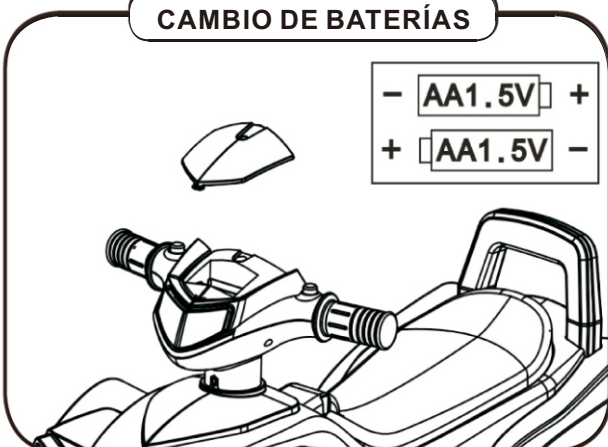

**Cómo cambiar la batería.**

- Afloje los tornillos con un destornillador.
- Mantenga los tornillos en un lugar seguro fuera del alcance de los niños.
- Coloque las baterías 2AA en la casa de baterías.
- Presione los botones en la manija para verificar que las baterías estén funcionando y para asegurarse de que el motor de revoluciones funcione bien, la bocina y las luces parpadeantes estén activadas de forma correcta, antes de fijar los tornillos ".



### **ATTENZIONE:**

- Questa confezione contiene parti di piccole dimensioni destinate esclusivamente all'assemblaggio da parte di adulti.
- Prestare attenzione durante il disimballaggio e il montaggio del giocattolo.



### **AVVERTENZA**

**RICHIESTO L'ASSEMBLAGGIO  
DA UN ADULTO**

**IMPORTANTE! CONSERVARE IL PRESENTE MANUALE PER FUTURO RIFERIMENTO E LEGGERLO ATTENTAMENTE.**

# ISTRUZIONI DI ASSEMBLAGGIO

## **Avvertenze:**







- 1-La macchinina è pensata per bambini di età compresa tra 12 e 36 mesi. Il peso massimo non deve superare i 25kgs (55lbs).
- 2-Il prodotto è progettato per ospitare 1 bambino per volta per evitare lesioni.
- 3-Si consiglia vivamente la guida sotto la supervisione dei genitori per garantire una guida sicura.
- 4-Per garantire la sicurezza sono necessari il montaggio e l'installazione da parte di un adulto per tutte le parti.
- 5-Evitare di avvicinarsi a strade, zone trafficate, piscine o scale durante la guida.
- 6-Controllare regolarmente il prodotto per assicurarsi che tutto sia sicuro. In particolare, il dado e il bullone sul volante devono essere fissati in sicurezza.
- 7-Potrebbero verificarsi pericoli se il prodotto non è assemblato correttamente.
- 8-Le scarpe devono essere indossate durante l'uso.

## **Gestione della batteria:**

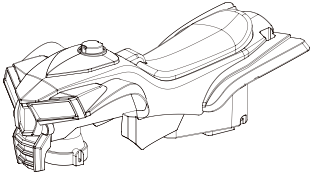
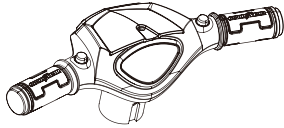
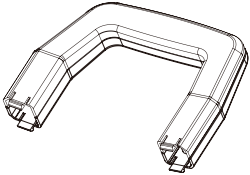
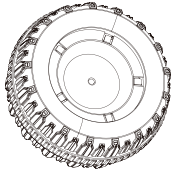
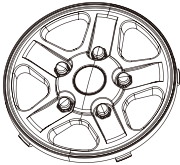
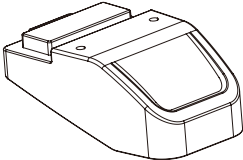
- 1-La batteria deve essere maneggiata solo da adulti.
- 2-Rimuovere sempre le batterie scariche.
- 3-Utilizzare 2 batterie formato AA (non incluse) per far funzionare le luci e il suono.
- 4-Si consigliano batterie alcaline.
- 5-Rimuovere sempre le batterie quando l'unità non verrà utilizzata per un lungo periodo di tempo.
- 6-Quando si sostituiscono nuove batterie, sostituire sempre tutte le batterie.
- 7-Non mescolare batterie vecchie e nuove.
- 8-Non mescolare batterie alcaline, standard (carbonio-zinco) o ricaricabili (nichel-cadmio).
- 9-Non gettare le batterie nel fuoco, le batterie potrebbero esplodere o perdere liquido.

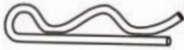
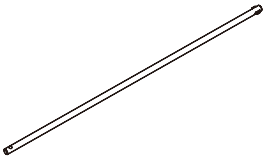
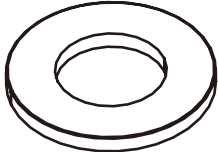
# ISTRUZIONI DI ASSEMBLAGGIO

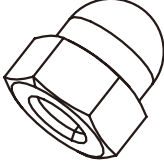
## LISTA PARTI

1. Telaio macchina x 1		2. Manubrio x 1	
3. Schienale x 1		4. Ruote x 4	
5. Cerchione x 4		6. Ripiano anti-caduta x 1	
7. Anello in plastica x 4		8. Coppiglia x 2	
9. Axle x 2		10. Rondella x 4	
11. Vite x 1		12. Dado x 1	
13. Bullone x 2			

### < PASSAGGIO 1 >

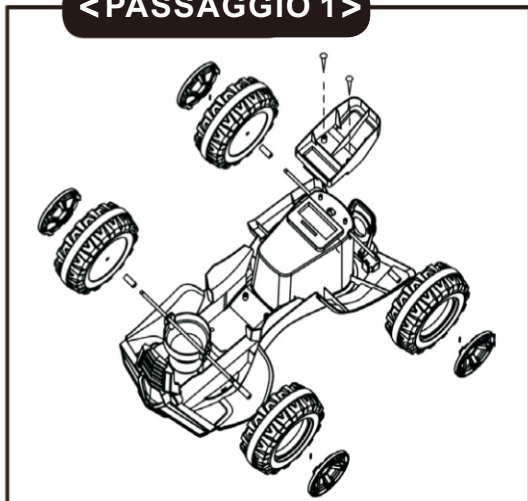

#### Come assemblare le ruote:

- Inserire l'asse attraverso gli anelli di plastica nel telaio principale dell'auto, fissare usando una coppiglia.
- Montare i cerchioni delle quattro ruote.

#### Come assemblare il ripiano anti-caduta:

- Posizionare il ripiano anti-caduta nella parte posteriore del veicolo.
- Montare le due viti con un cacciavite.

### < PASSAGGIO 2 >



#### Come assemblare il manubrio:

- Posizionare il manubrio.
- Inserire il bullone nel foro e stringere con un cacciavite.

#### Come assemblare lo schienale per bambini:

- Posizionare lo schienale per bambini sopra i fori nella parte posteriore del prodotto.
- Tenendo premuta la parte anteriore del veicolo, spingere con forza lo schienale del bambino in modo che si adatti ai fori. Accertarsi che lo schienale per bambini sia montato correttamente.

### SOSTITUZIONE DELLA BATTERIA



#### Come sostituire la batteria.

- Allentare le viti con un cacciavite.
- Conservare le viti in un luogo sicuro lontano dalla portata dei bambini.
- Inserire le batterie 2AA nel vano batterie.
- Premere i pulsanti sull'impugnatura per verificare il funzionamento delle batterie e per accertarsi che il motore, il clacson e le luci lampeggianti siano attivati correttamente, prima di stringere le viti.

**UK**

If you have any questions, please contact our customer care centre.

Our contact details are below:



0044-800-240-4004



enquiries@mhstar.co.uk

IMPORTER ADDRESS:

MH STAR UK LTD

Unit 27, Perivale Park,

Horsenden lane South

Perivale, UB6 7RH

MADE IN CHINA

**ES**

Si tiene alguna pregunta, comuníquese con nuestro Centro de Atención al Cliente. Nuestros datos de contacto son los siguientes:



0034-931294512



atencioncliente@aosom.es

Importador/Fabricante/REP:

Spanish Aosom, S.L.

C/ Roc Gros, nº 15. 08550, Els Hostalets de Balenyà, Spain.

B66295775

atencioncliente@aosom.es

TEL: 931294512

HECHO EN CHINA

**FR**

Si vous avez la moindre question, veuillez contacter notre centre d'assistance à la clientèle.

Nos coordonnées sont les suivantes:



0033-1-84166106



aosom@mhfrance.fr

Importé par/Fabricant/REP:

MH France

2, rue Maurice Hartmann

92130 Issy-les-Moulineaux

France

Fabriqué en Chine

**PT**

Se tiver alguma dúvida, por favor contacte o nosso Centro de Atendimento ao Cliente. Os nossos dados de contacto são os seguintes:



0034-931294512



info@aosom.pt.

IMPORTADOR:

SPANISH AOSOM, S.L

C.ROC GROS N.15, 08550. ELS HOSTALETES DE BALENYÀ

TEL: 931294512 (SEG-SEX DAS 7:30H ÀS 16:30H)

INFO@AOSOM.PT

WWW.AOSOM.PT

**DE**

Wenn Sie Fragen haben, wenden Sie sich bitte an unser Kundendienstzentrum.

Unsere Kontaktdaten stehen unten:



0049-0(40)-87408465



service@aosom.de

Importeur/Hersteller/REP:

MH Handel GmbH

Wendenstraße 309

D-20537 Hamburg

Germany

IN CHINA HERGESTELLT

**IT**

In caso di dubbio, si prega di contattare il nostro centro assistenza clienti. I nostri dettagli di contatto sono di seguito:



0039-0249471447



clienti@aosom.it

IMPORTATO DA/Produttore/REP:

AOSOM Italy srl

Centro Direzionale Milanofiori

Strada 1 Palazzo F1

20057 Assago (MI)

P.I.: 08567220960

FATTO IN CINA

