

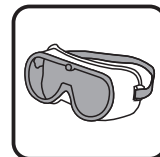

IN221100146V01_GL

845-390_845-390V00

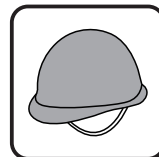
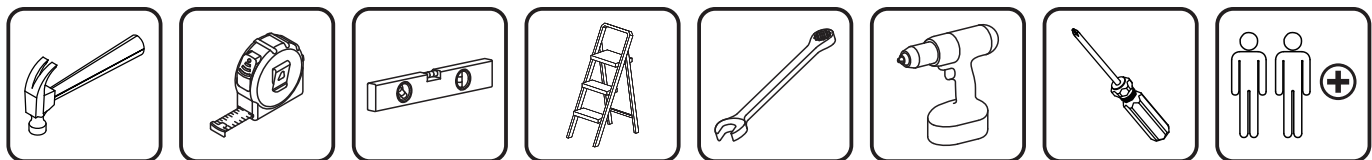
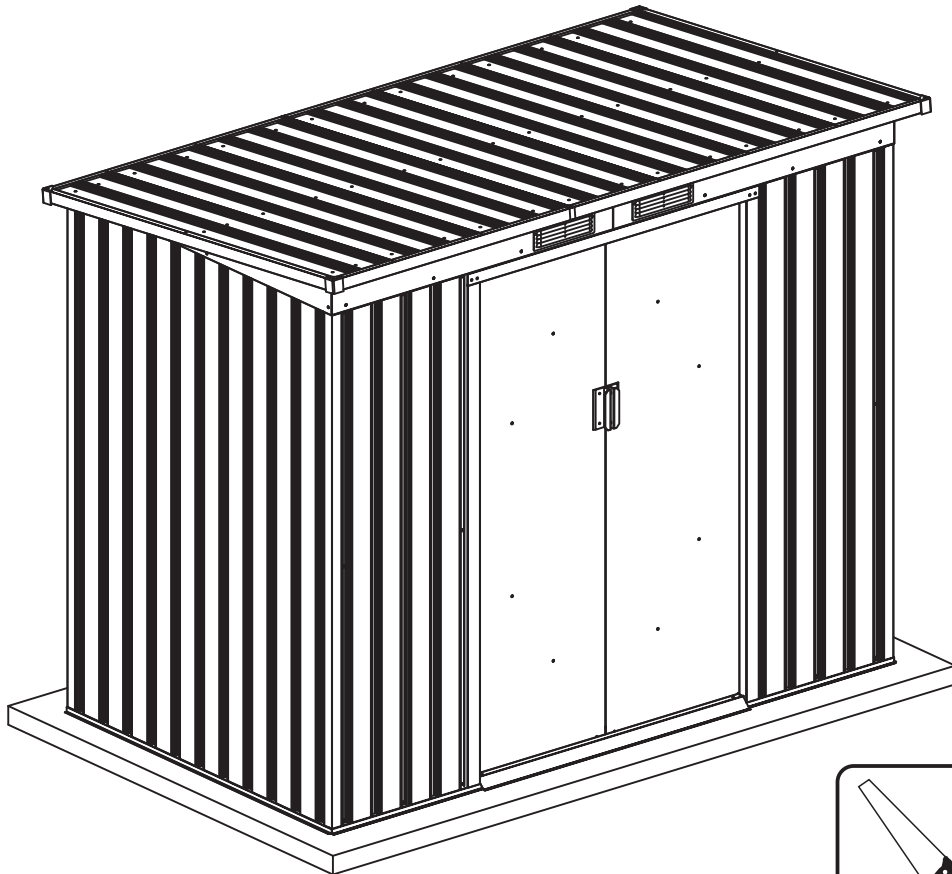

Tools Recommended

EN_IMPORTANT, RETAIN FOR FUTURE REFERENCE: READ CAREFULLY.

FR_IMPORTANT: A LIRE ATTENTIVEMENT ET À CONSERVER POUR CONSULTATION ULTÉRIEURE.

ES_IMPORTANTE, LEA Y GUARDE PARA FUTURAS REFERENCIAS.

PT_IMPORTANTE, RETER PARA REFERÊNCIA FUTURA: LEIA ATENTAMENTE.

DE_WICHTIG! SORGFÄLTIG LESEN UND FÜR SPÄTER NACHSCHLAGEN AUFBEWAHREN.

IT_IMPORTANTE! CONSERVARE IL PRESENTE MANUALE PER FUTURO RIFERIMENTO E LEGGERLO ATTENTAMENTE.

Manual del usuario

Please check local building codes regarding footings, location and other requirements before beginning construction. Study and understand this owner's manual of important information and helpful tips for easier and more enjoyable assembly.

Assembly instructions:

Reviewing all instructions and the appropriate information before you begin, make sure following the step sequence carefully for successful results.

Flooring base:

A good location for the storage building is a square and level area with good drainage.

A strong plastic sheet (thickness: at least 150µm) should be placed under the foundation to assist in reducing rising dampness from the soil, thus reducing condensation build up in the shed. Your storage building must be anchored to prevent wind damage. Once secured, it is highly recommended applying silicone along the inside of the base rail to minimize condensation.

Parts and Parts List:

Before you start, separate and identify all the parts and hardware to be sure that you have all the necessary parts for your building (refer to the Parts List Page).

If you find that a part is missing, please notify the seller within one week after receiving the product. Do not attempt to assemble the building if parts are missing because any building left partially assembled may be seriously damaged by light winds.

(Please tear off the safety protection layer before the assembly, keep the part number label if needed)

Safety must be put in the No. 1 position:

- 1 Select a dry and calm day for your assembly. Team works (Two or more people) are required during the assembly;
- 2 Wearing safety gloves, eye protection and long sleeves during the assembly to prevent injury; Pay attention to the sharp edge of some parts;
- 3 Children and pets are not allowed entering into the construction site;
- 4 Never concentrate your total weight on the roof of the building. When using a step ladder make sure that it is safety;

Care & Maintenance:

- 1 Keep the shed clean with soft cloth, use water if necessary;
- 2 Keep the door tracks clear of dirt and other stuff that prevent them from sliding easily.
- 3 Clean the snow with necessary tools to make sure it is safe to enter into; Heavy snow may cause collapse, please make sure safety before entering into.
- 4 The shed is not made for living but storing stuff.
- 5 Please add some oil on the top and bottom door sliding channel to make door slides smoothly.

Le manuel du propriétaire

Veillez vérifier les codes du bâtiment locaux concernant les semelles, l'emplacement et d'autres exigences avant de commencer la construction. Étudiez et comprenez dans ce manuel d'information les informations importantes et les conseils utiles pour un montage plus facile et plus agréable.

Instructions de montage :

Avant de commencer, passez en revue toutes les instructions et les informations appropriées. Assurez-vous de suivre attentivement la séquence des étapes pour obtenir des résultats satisfaisants.

Base de plancher :

Un bon emplacement pour le bâtiment de stockage est une zone carrée et plane avec un bon drainage.

Une feuille de plastique solide (épaisseur : au moins 150µm) doit être placée sous la fondation pour aider à réduire l'humidité ascendante du sol, réduisant ainsi l'accumulation de condensation dans le hangar. Votre bâtiment de stockage doit être ancré pour éviter les dommages causés par le vent. Une fois fixé, il est fortement recommandé d'appliquer du silicone le long de l'intérieur du rail de base pour minimiser la condensation.

Pièces et liste des pièces :

Avant de commencer, séparez et identifiez toutes les pièces et le matériel pour vous assurer que vous avez toutes les pièces nécessaires pour votre bâtiment (voir la page Liste des pièces).

Si vous constatez qu'une pièce est manquante, veuillez en informer le vendeur dans la semaine qui suit la réception du produit. N'essayez pas d'assembler le bâtiment si des pièces manquent, car tout bâtiment laissé partiellement assemblé peut être gravement endommagé par de légers vents.

(Veillez déchirer la couche de protection avant l'assemblage, conservez l'étiquette du numéro de pièce si nécessaire)

La sécurité doit être votre préoccupation no.1 :

1 Sélectionnez un jour sec et calme pour votre assemblée. Le travail en équipe (deux personnes ou plus) est requis pendant le montage.

2 Porter des gants de protection, des lunettes de protection et des manches longues pendant le montage pour éviter les blessures ; Faites attention au bord tranchant de certaines parties ;

3 Les enfants et les animaux domestiques ne sont pas admis sur le chantier de construction.

4 Ne concentrez jamais votre poids total sur le toit du bâtiment. Lorsque vous utilisez un escabeau, assurez-vous qu'il est en sécurité.

Entretien et maintenance :

1 Gardez la remise propre avec un chiffon doux, utilisez de l'eau si nécessaire ;

2 Gardez les rails de la porte exempts de saleté et autres objets qui les empêchent de glisser facilement.

3 Nettoyer la neige avec les outils nécessaires pour s'assurer qu'il est sans danger d'entrer ; Une neige abondante peut provoquer un effondrement, assurez-vous de la sécurité avant d'entrer.

4 La remise n'est pas faite pour soulever mais pour ranger des objets.

5 Veuillez ajouter un peu d'huile sur les glissières supérieure et inférieure de la porte pour que celle-ci glisse en douceur.

Manual del usuario

Antes de comenzar la construcción, consulte los códigos de construcción locales con respecto a las bases, la ubicación y otros requisitos. Estudie y comprenda este manual del propietario ya que contiene información importante y consejos útiles para un montaje más fácil y agradable.

Instrucciones de montaje

Revise todas las instrucciones y la información apropiada antes de comenzar, asegúrese de seguir cuidadosamente la secuencia de pasos para obtener resultados exitosos.

Base de suelo:

El cobertizo de almacenamiento debe instalarse en un lugar cuadrado y nivelado con buen drenaje.

Se debe colocar una lámina de plástico resistente (espesor: al menos 150 μm) debajo de la base para ayudar a reducir la humedad del suelo, reduciendo así la acumulación de condensación en el cobertizo. Su cobertizo de almacenamiento debe estar anclado para evitar daños por viento. Una vez instalado, se recomienda aplicar silicona a lo largo del interior del riel de base para minimizar la condensación.

Lista de Piezas y Accesorios:

Antes de comenzar, separe e identifique todas las piezas y el hardware para asegurarse de que tiene todas las piezas necesarias para su cobertizo (consulte la página de Lista de Piezas).

Si encuentra que haya faltante, notifique al vendedor dentro de una semana después de recibir el producto. No intente ensamblar el cobertizo si faltan piezas, porque cualquier cobertizo parcialmente ensamblado puede resultar seriamente dañado por vientos ligeros.

(Quite la capa de protección de seguridad antes del montaje, mantenga la etiqueta del número de pieza si es necesario)

La seguridad se debe enfocar en la posición No. 1.

- 1 Seleccione un día seco y tranquilo para su montaje. Se requiere trabajo en equipo (dos o más personas) durante el montaje.
- 2 Use guantes de seguridad, protección ocular y mangas largas durante el montaje para evitar lesiones; Preste atención al borde afilado de algunas partes.
- 3 Los niños y las mascotas no pueden ingresar al sitio de construcción.
- 4 Nunca concentre su peso total en el techo del edificio. Cuando utilice una escalera de mano, asegúrese de que sea segura.

Cuidado y Mantenimiento

- 1 Mantenga limpio el cobertizo con un paño suave, use agua si es necesario.
- 2 Mantenga los rieles de las puertas libres de suciedad y otras cosas que eviten que se deslicen fácilmente.
- 3 Limpie la nieve con las herramientas necesarias para asegurarse de que sea seguro ingresar; Las fuertes nevadas pueden provocar un colapso, por favor asegúrese de seguridad antes de entrar.
- 4 El cobertizo no está hecho para vivir sino para almacenar cosas.
- 5 Agregue un poco de aceite en la guía de la puerta superior e inferior para que la puerta se deslice suavemente.

Bedienungsanleitung

Vor Beginn der Bauarbeiten überprüfen Sie bitte die örtlichen Bauvorschriften in Bezug auf Fußböden, Standort und andere Anforderungen. Lesen und verstehen Sie diese Bedienungsanleitung mit wichtigen Informationen und hilfreichen Tipps für eine einfachere und angenehmere Montage.

Montageanweisung:

Überprüfen Sie alle Anweisungen und die entsprechenden Informationen, bevor Sie beginnen. Stellen Sie bitte sicher, dass Sie die Schrittsequenz sorgfältig befolgen, um erfolgreiche Ergebnisse zu erzielen.

Bodenbelag:

Ein guter Standort für das Lagergebäude ist ein quadratischer und ebener Bereich mit guter Entwässerung.

Eine starke Kunststoffplatte (Dicke: mindestens 150 µm) sollte unter das Fundament gelegt werden, um die Feuchtigkeit aus dem Boden zu verringern und so die Kondenswasserbildung im Schuppen zu verringern. Ihr Lagergebäude muss verankert sein, um Windschäden zu vermeiden. Nach dem Sichern wird dringend empfohlen, Silikon entlang der Innenseite der unteren Führungsschiene aufzutragen, um die Kondensation zu minimieren.

Teile und Teileliste:

Bevor Sie beginnen, trennen und identifizieren Sie alle Teile und Hardware, um sicherzustellen, dass Sie alle erforderlichen Teile für Ihr Gebäude haben (siehe Seite Teileliste).

Wenn Sie feststellen, dass Teile fehlen, benachrichtigen Sie bitte den Verkäufer innerhalb einer Woche nach Erhalt des Produkts. Versuchen Sie nicht, das Gebäude zusammenzubauen, wenn Teile fehlen, da ein teilweise zusammengebautes Gebäude durch leichten Wind ernsthaft beschädigt werden kann.

(Bitte entfernen Sie die Schutzschicht der Sicherheit vor der Montage. Bei Bedarf bewahren Sie die Artikelnummer auf)

Achten Sie erst auf die Sicherheit :

- 1 Wählen Sie einen trockenen und ruhigen Tag für Ihre Montage aus. Teamarbeiten (Zwei oder mehr Personen) sind während der Montage erforderlich;
- 2 Tragen Sie die Schutzhandschuhe, Augenschutz und lange Ärmel bei der Montage zur Vermeidung von Verletzungen; Achten Sie auf die scharfe Kante für einige Teile;
- 3 Die Kinder und Haustiere dürfen nicht auf die Baustelle betreten;
- 4 Konzentrieren Sie niemals Ihr Gesamtgewicht auf das Dach des Gebäudes. Bei Verwendung einer Trittleiter sollen Sie die Sicherheit gewährleisten.

Pflege und Wartung:

- 1 Halten Sie den Schuppen mit einem weichen Tuch sauber, verwenden Sie das Wasser wenn nötig;
- 2 Halten Sie die Türschiene von Schmutz und anderen Gegenständen fern, damit sie nicht leicht verrutschen können.
- 3 Reinigen Sie den Schnee mit den notwendigen Werkzeugen, um sicherzugehen, dass Sie sicher betreten können; Starker Schneefall kann zum Einsturz führen, bitte gewährleisten Sie die Sicherheit vor dem Betreten .
- 4 Der Schuppen ist nicht zum Wohnen gemacht, sondern zum Aufbewahren von Sachen.
- 5 Bitte geben Sie etwas Öl auf den oberen und unteren Schiebekanal der Tür, damit die Tür reibungslos gleitet.

Manuale d'istruzioni

Prima di iniziare, si prega di verificare i regolamenti edilizi locali relativi alle fondamenta, alla posizione e ad altri requisiti. Si prega di studiare e comprendere questo manuale di informazioni importanti e suggerimenti utili per un assemblaggio più semplice.

Istruzioni di assemblaggio:

Si prega di visionare tutte le istruzioni e le informazioni prima di iniziare, accertandosi di seguire attentamente la sequenza di passaggi.

Fondazione del pavimento:

Una buona posizione per la costruzione di stoccaggio è un'area quadrata e piana con un buon drenaggio.

Un foglio di plastica resistente (spessore: al minimo 150µm) dovrebbe essere posizionato sotto la fondazione per ridurre l'umidità derivata dal suolo, riducendo così l'accumulo di condensa di umidità nel capannone. La tua costruzione di stoccaggio deve essere ancorato per evitare danni causati dal vento. Una volta fissato, si consiglia vivamente di applicare il silicone lungo l'interno della guida di base per ridurre al minimo la condensa.

Parti e lista delle parti:

Prima di iniziare, separare e identificare tutte le parti e l'hardware per essere sicuri di disporre di tutte le parti necessarie per la costruzione (fare riferimento alla pagina della Lista delle Parti).

Se scoprite che manca una parte, avvisare il venditore entro una settimana dalla ricezione del prodotto. Non tentare di montare la costruzione se mancano parti perché qualsiasi costruzione lasciata parzialmente assemblata può essere seriamente danneggiata da venti leggeri.

(Si prega di rimuovere la pellicola di protezione prima del montaggio, mantenere l'etichetta del numero di parte, se necessario)

La sicurezza deve venire prima di tutto:









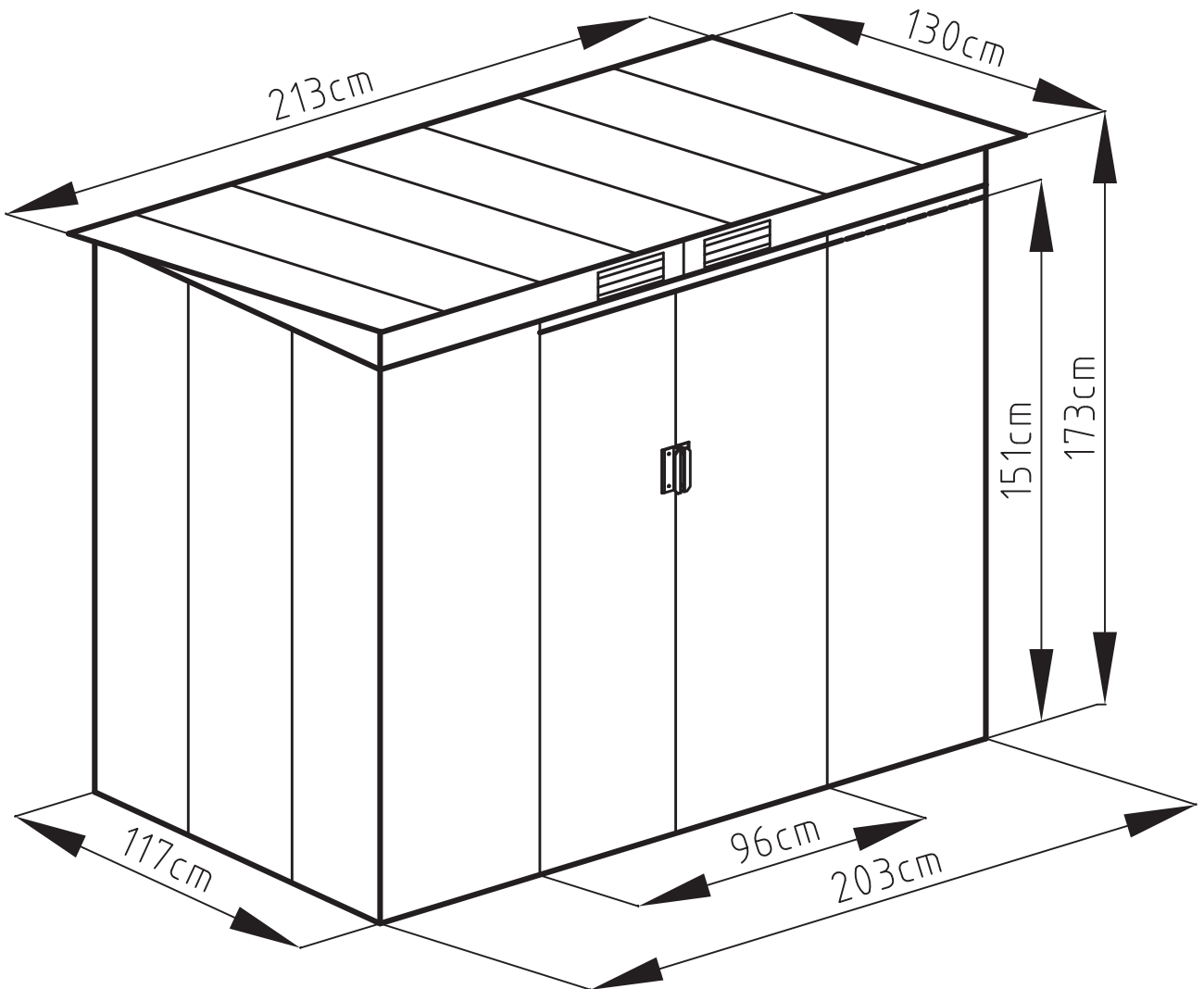
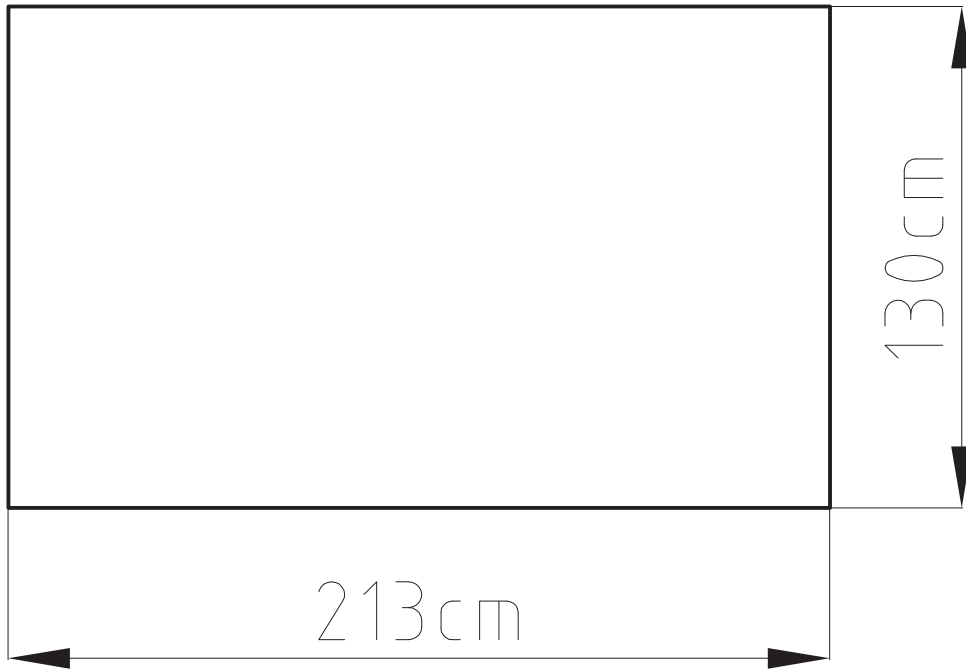







- 1 Scegli un giorno asciutto e calmo per il tuo assemblaggio. Il lavoro di gruppo (due o più persone) è richiesto durante l'assemblaggio;
- 2 Indossare guanti di sicurezza, occhiali protettivi e maniche lunghe durante l'assemblaggio per evitare lesioni. Prestare attenzione al bordo tagliente di alcune parti;
- 3 Ai bambini e agli animali domestici non è consentito entrare nel cantiere;
- 4 Non concentrare mai il peso totale sul tetto dell'edificio. Quando si utilizza una scala a pioli, assicurarsi che sia sicura;











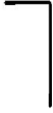





Manutenzione:

- 1 Tenere il capanno pulito con un panno morbido, usare acqua se necessario;
- 2 Tenere i binari della porta liberi da sporcizia e altre cose che impediscano loro di scivolare facilmente.
- 3 Pulisci la neve con gli strumenti necessari per assicurarti che sia sicuro entrare; La neve pesante può causare il collasso, controlla che sia sicuro prima di entrare.
- 4 Il capanno non è ideato come zona abitativa, ma solo come magazzino.
- 5 Si prega di aggiungere un po' di olio sul binario scorrevole superiore e inferiore della porta per rendere la porta scorrere più facile.

AREA OF INSTALLATION REQUIREMENT



Name of parts	Section	QTY(pcs)
Box 1/2		
Bm-A7		8
Bm-A7a		1
Bn-A23		1
Bn-A24		5
Bn-A25		1
Instruction manual		1
Box 2/2		
Bm-8		4
Bn-A19b		1
Bn-A19c		1
Bn-A21b		1
Bn-A21c		1
Bs-A1		1
Bs-A2		1
Bs-A3		2
Bs-A4		1
Bs-A5		1
Bs-A6		1
Bs-A9		1
Bs-A10		1
Bn-A11		1
Bn-A12		1
Bn-A13		2
Bm-16		1
Bm-17		1
Bs-A18		1
Bm-A30		1
Bm-A35		1

Name of parts	Section	QTY(pcs)
Bs-A28		1
Bs-A28a		1
Bn-A40		1
Bn-A26		1
Bn-A26a		1
Bm-A38		1
Bm-A38a		1
Bm-39		2
T-X29		
Bm-31		2
Bm-A32		4
Bs-A33		1
Bs-A34		1
Bs-A36		1
Bs-A37		1
Bn-A56		6
T-P7		1
T-P1		4
T-P2		4
BCP3		4
TP5A		2
T-P6		2
Bn-A50		154
Bn-A51		162
Bn-A52		16
Bn-A53		97
Bn-A54		72
V-A1		5
V-A2		2

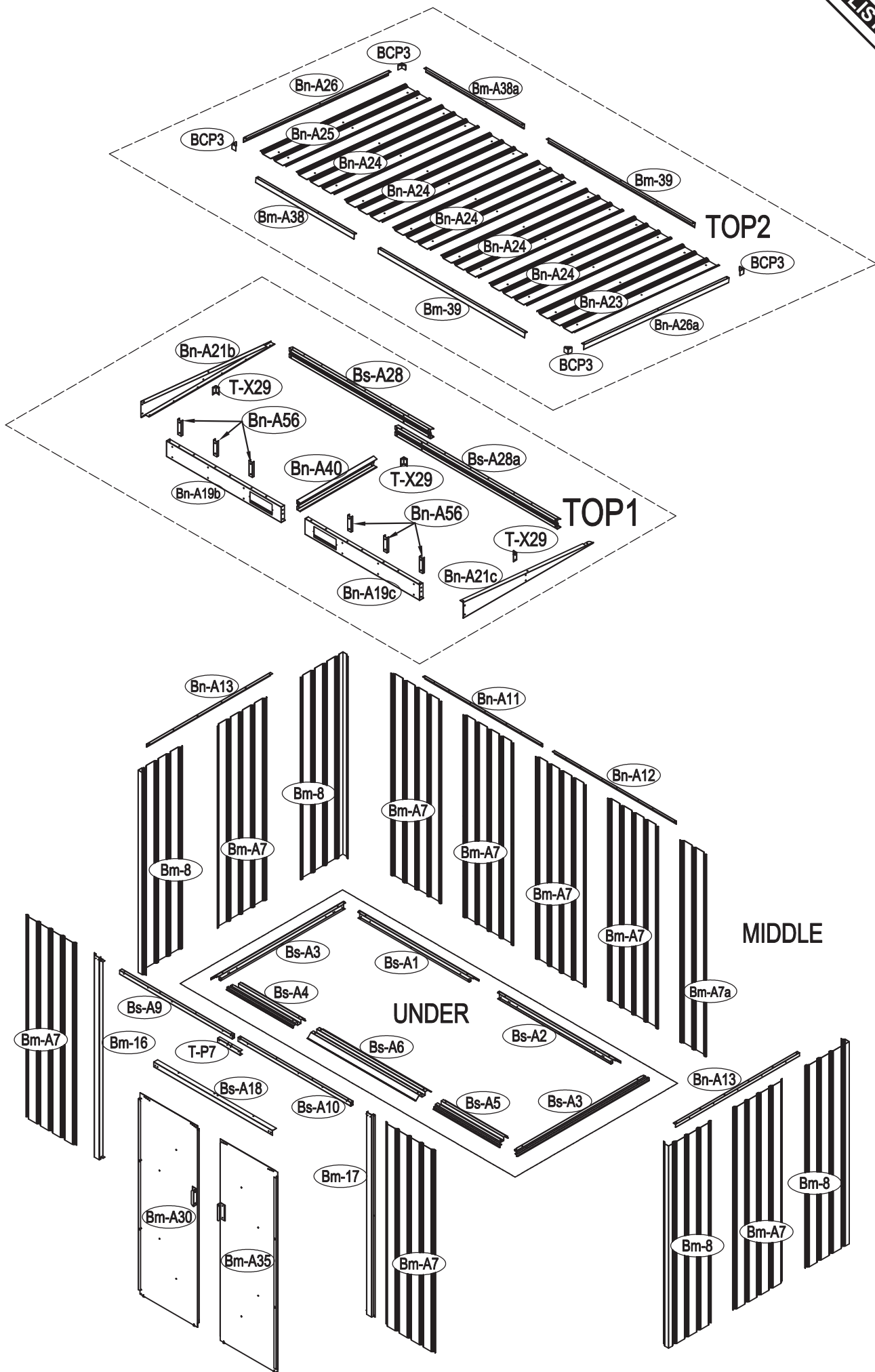

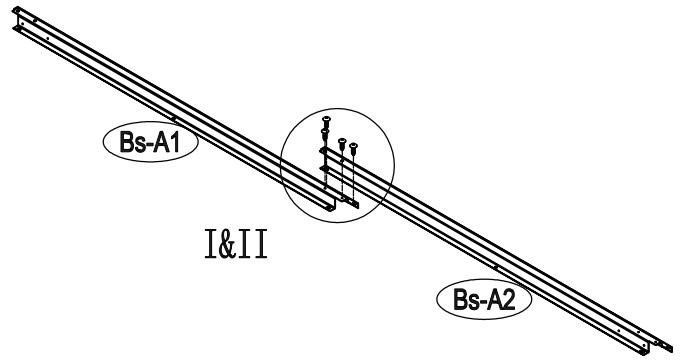
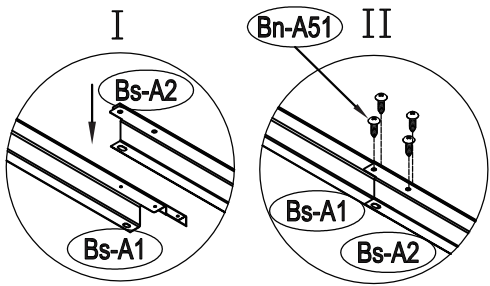

Bn-A51		x4
--------	---	----

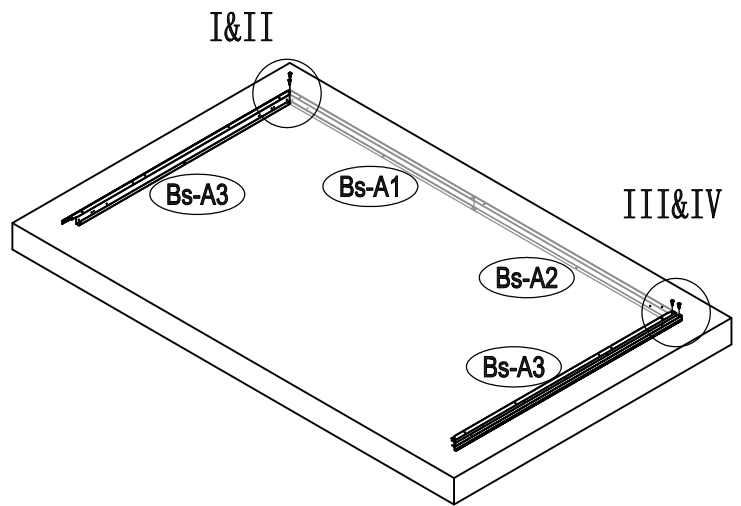
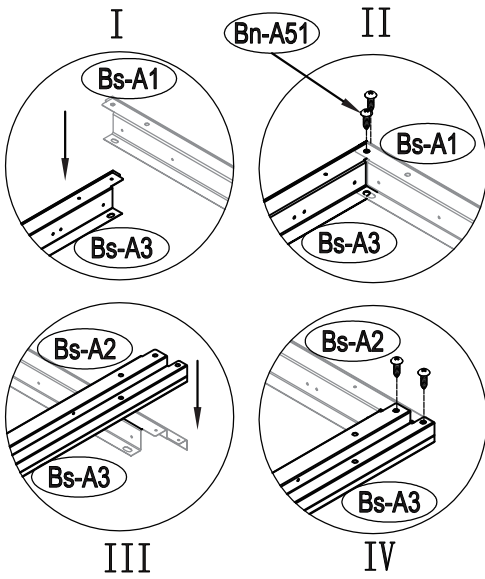

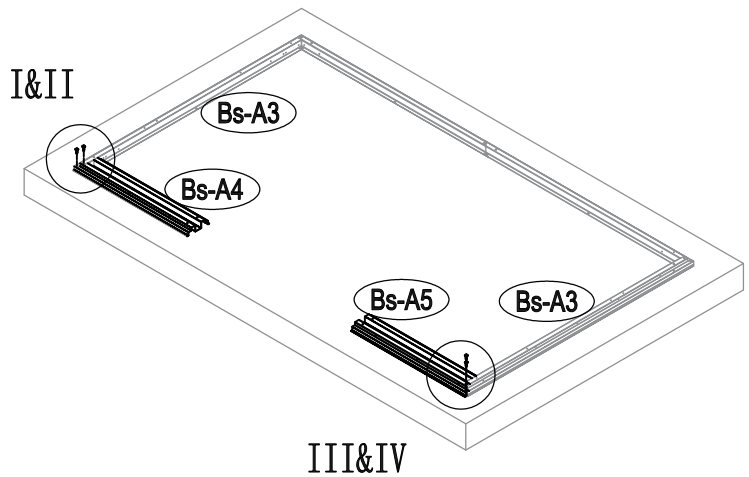
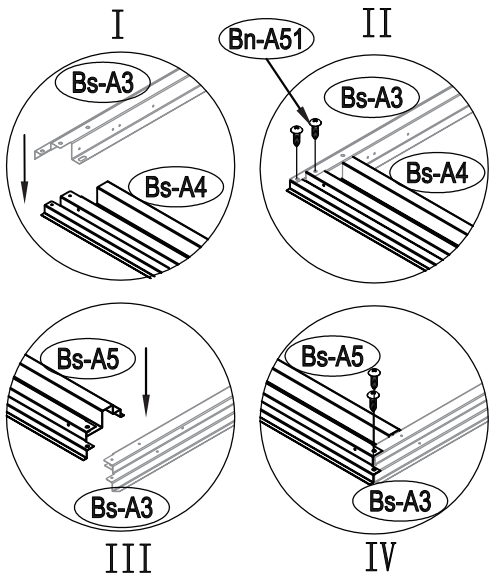

Bn-A51		x4
--------	---	----



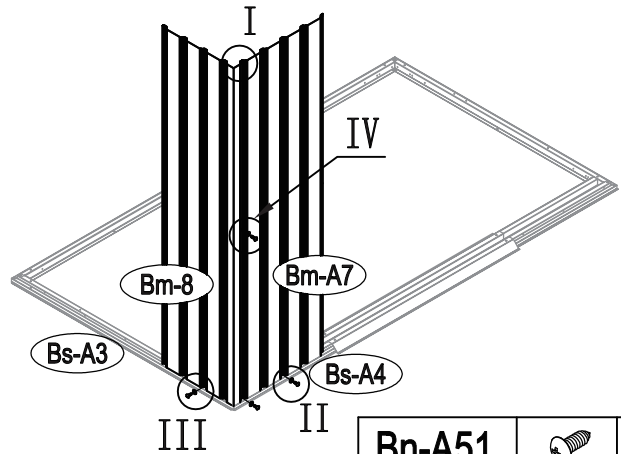
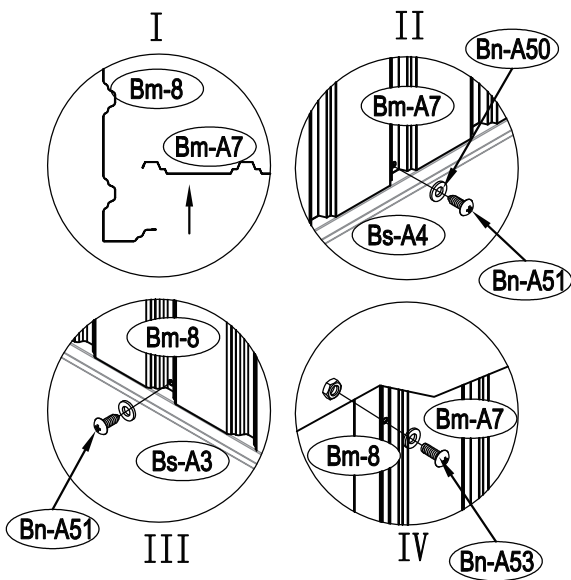
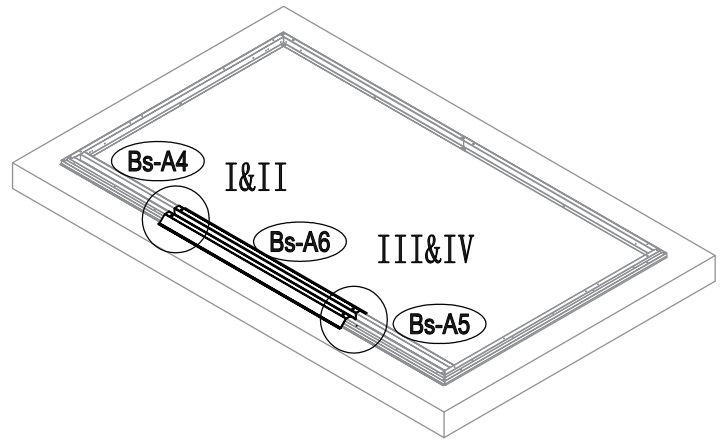
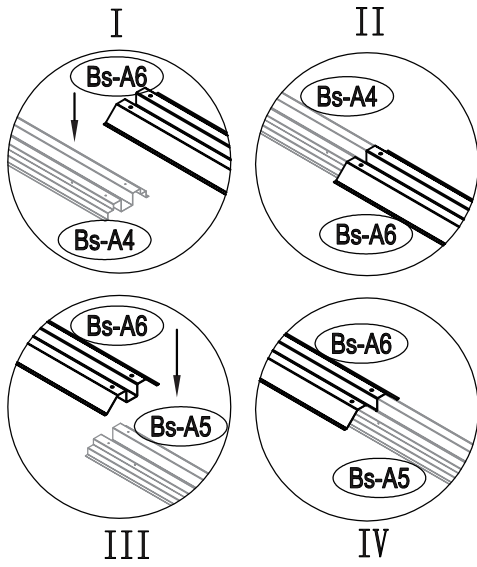

Bn-A51		x4
--------	---	----

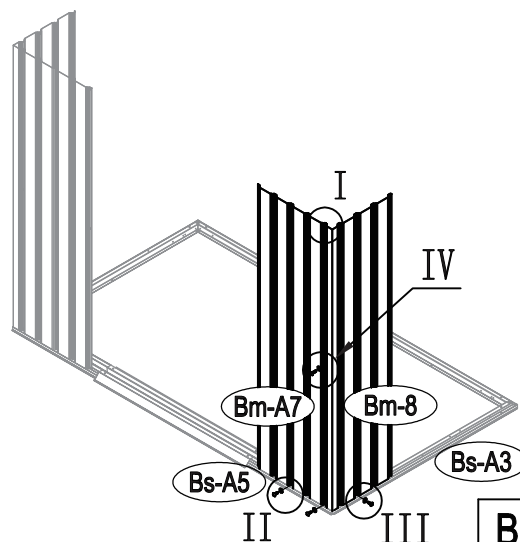
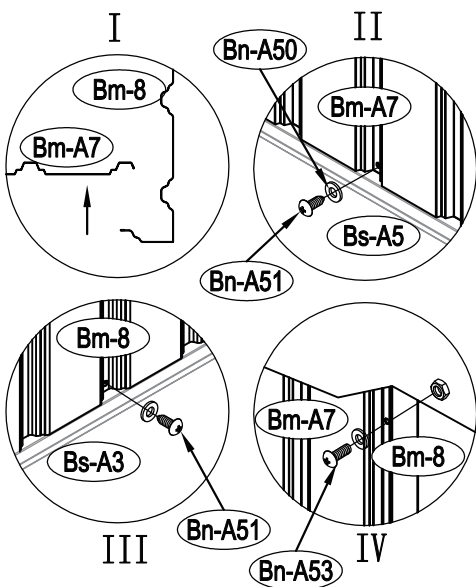

Bn-A51		x3
Bn-A53		x1



Bn-A51		x3
Bn-A53		x1

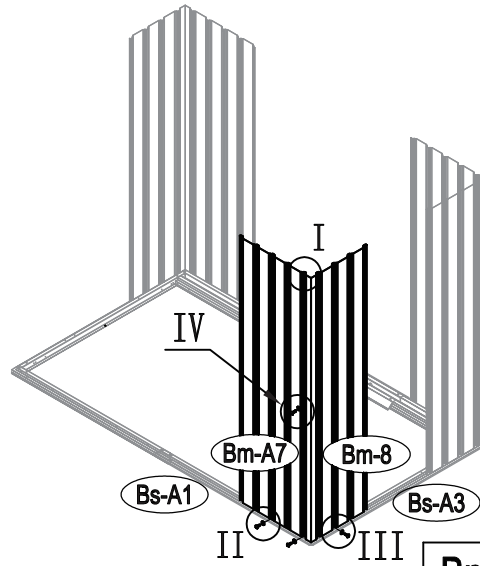
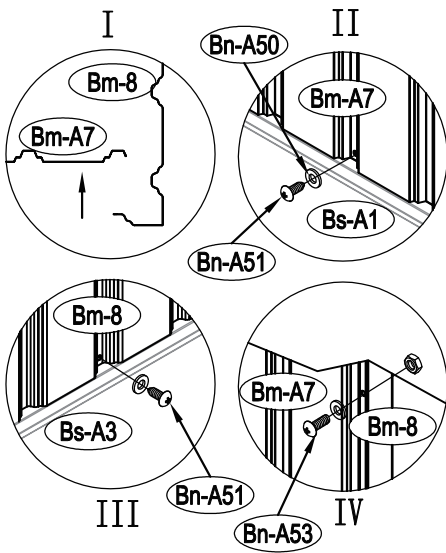

Bn-A51		x3
Bn-A53		x1

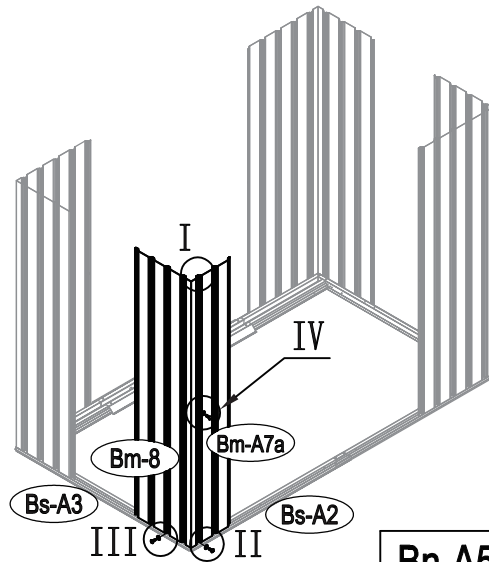
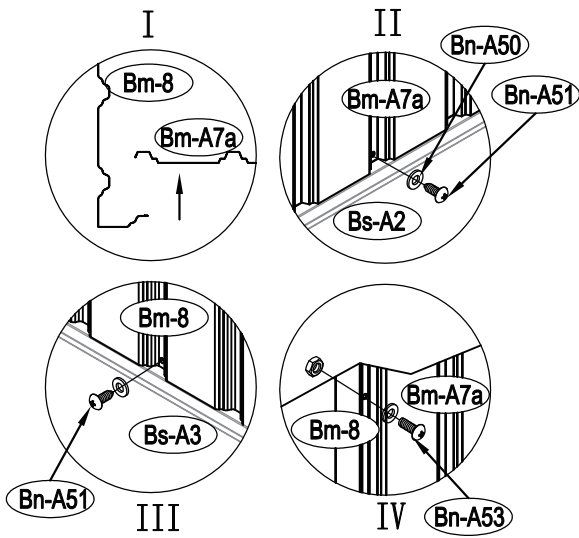

Bn-A51		x2
Bn-A53		x1

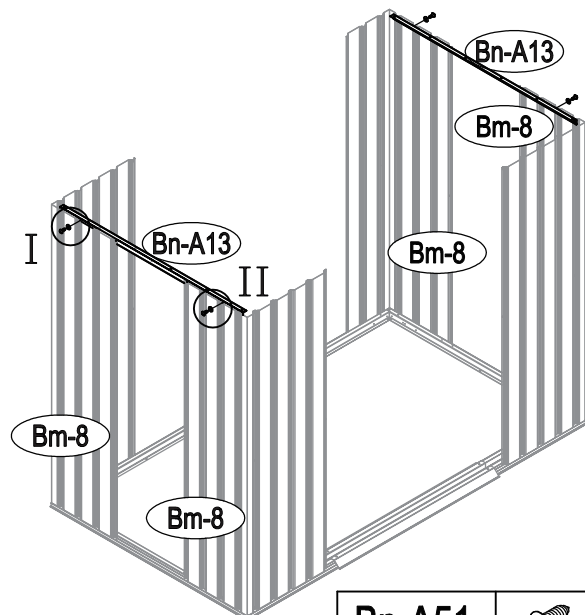
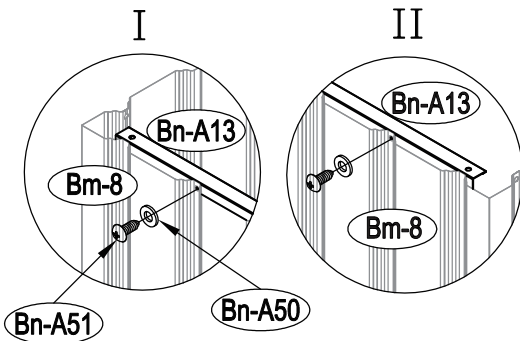

Bn-A51		x4
--------	--	----

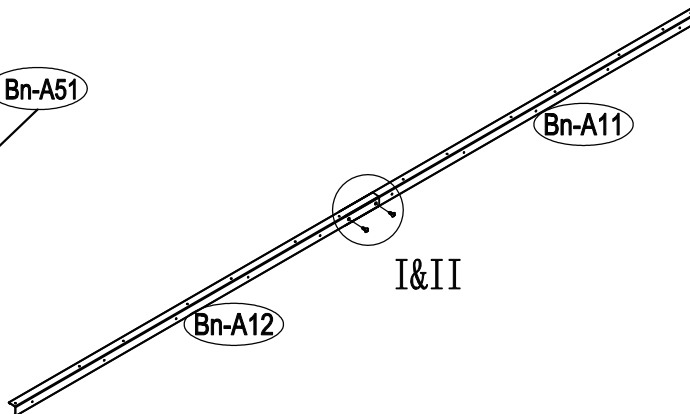
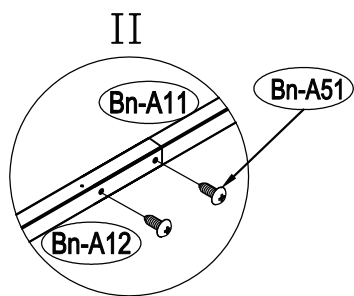
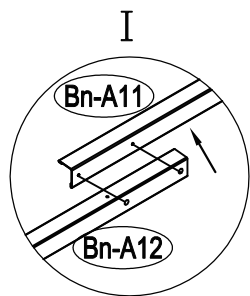

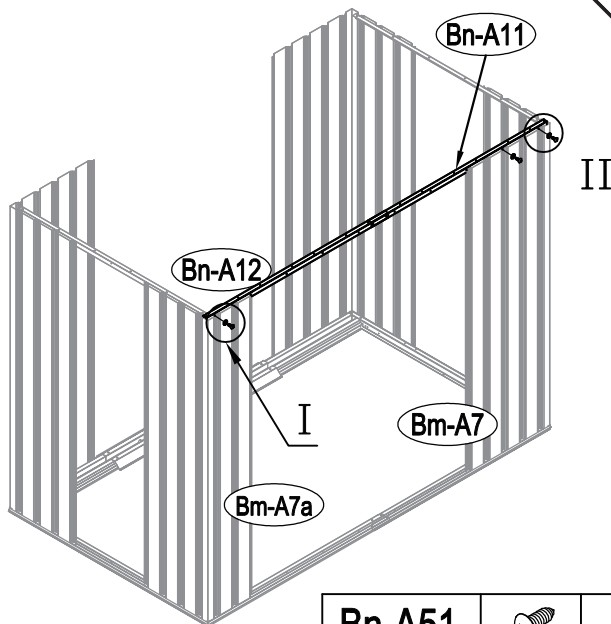
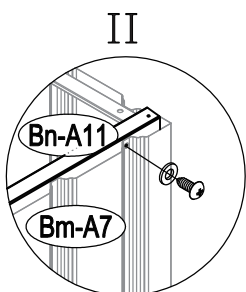
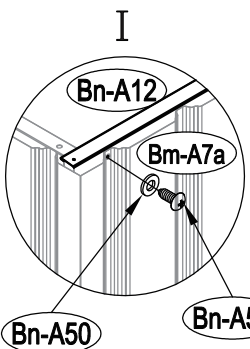

Bn-A51		x2
--------	---	----

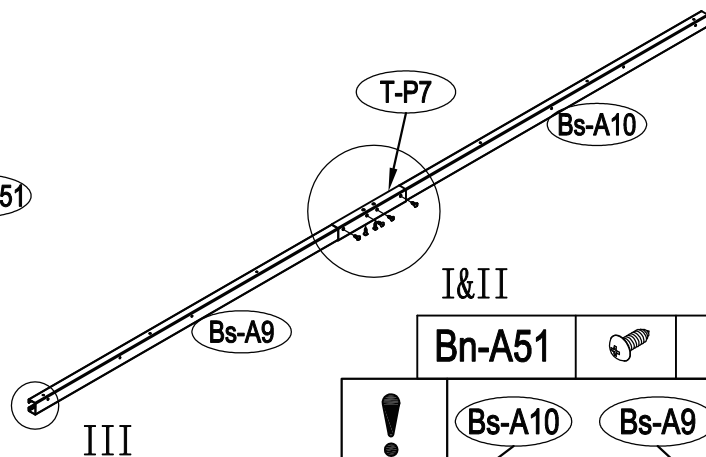
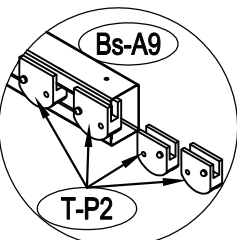
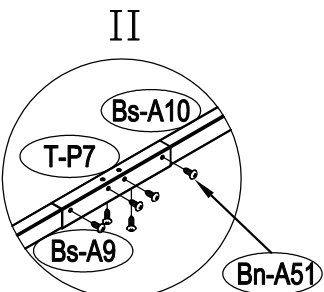
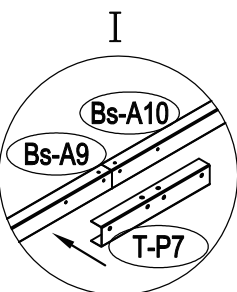

Bn-A51		x3
--------	---	----



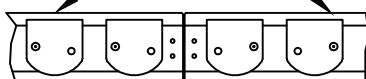

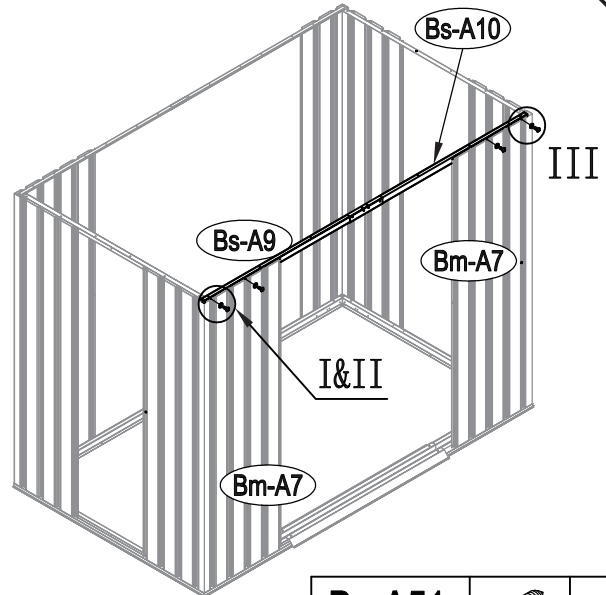
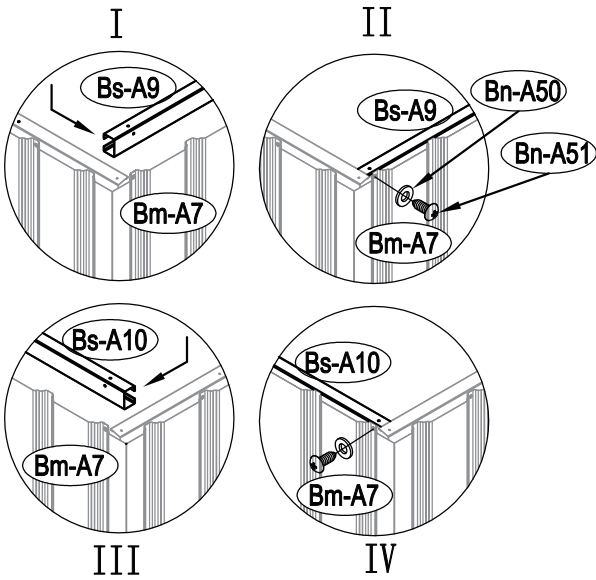
Bn-A51		x6
	Bs-A10	Bs-A9
		

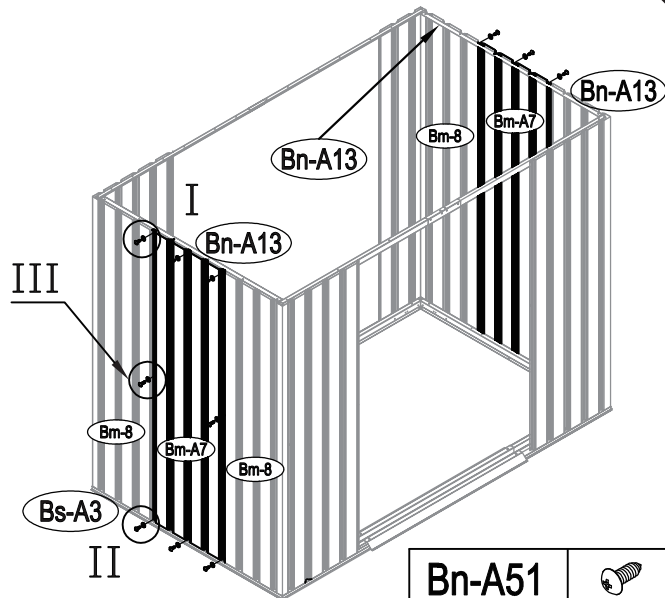
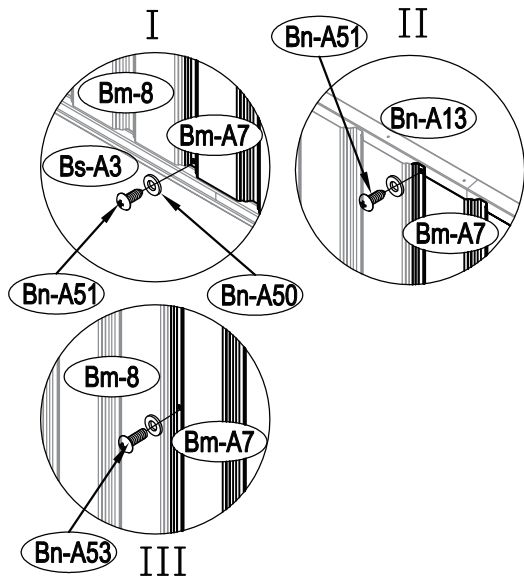

Bn-A51		x4
--------	---	----



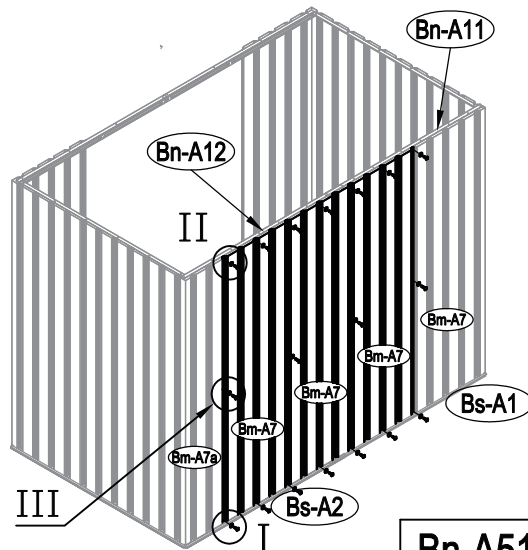
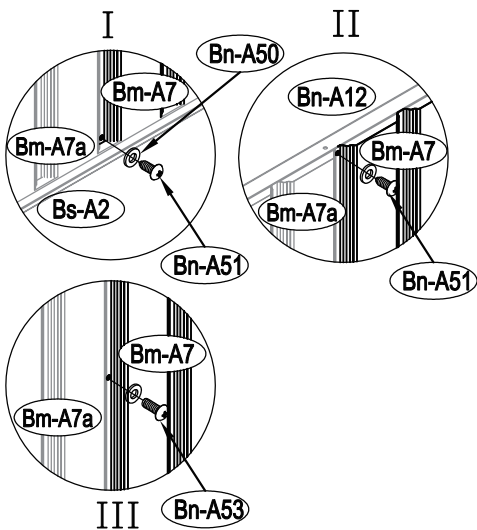

Bn-A51		x12
Bn-A53		x4



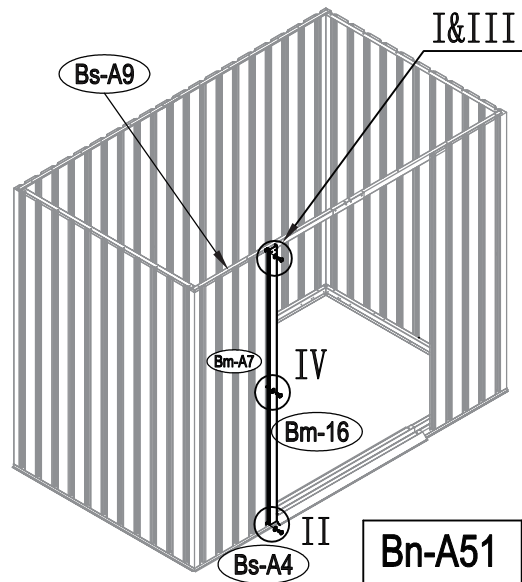
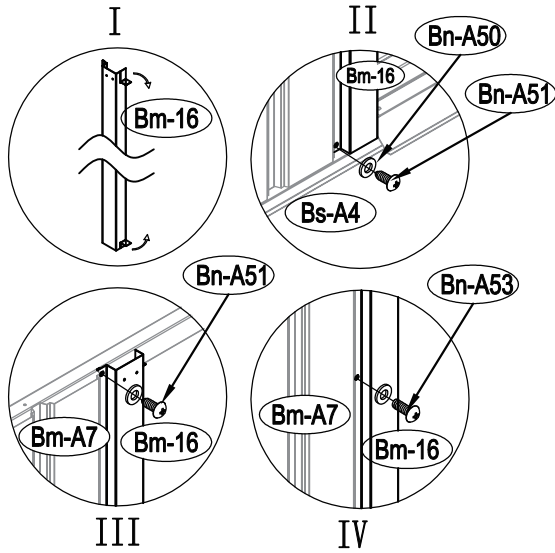

Bn-A51		x14
Bn-A53		x4

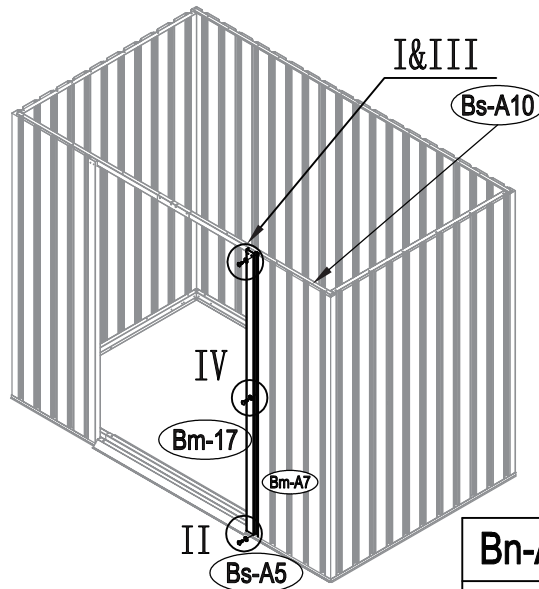
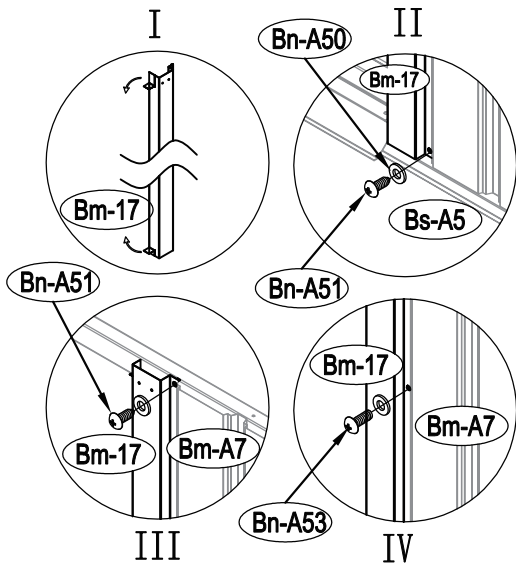

Bn-A51		x2
Bn-A53		x1



Bn-A51		x2
Bn-A53		x1

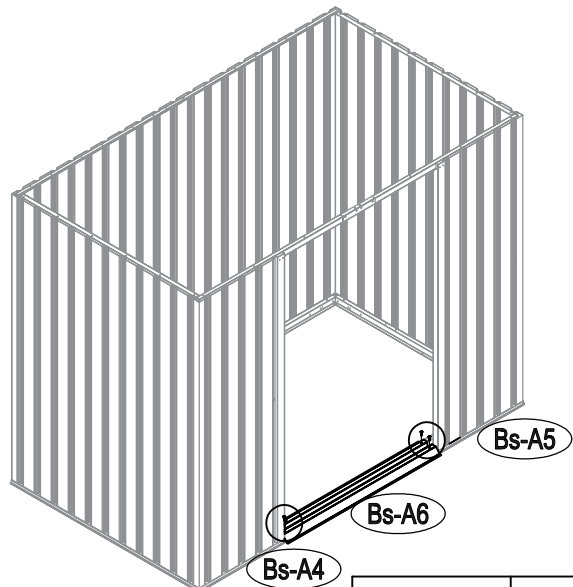
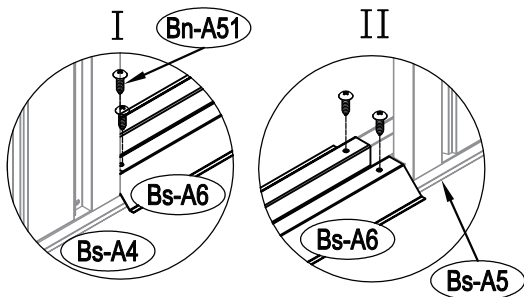

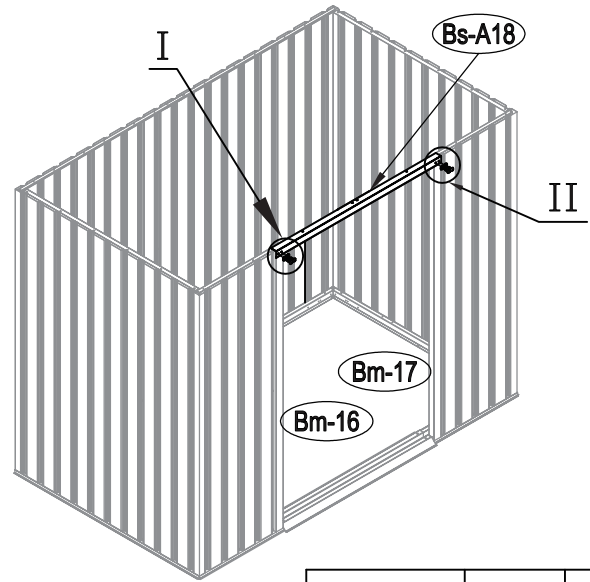
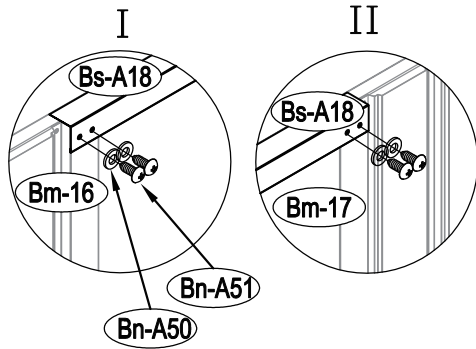

Bn-A51		x4
--------	---	----

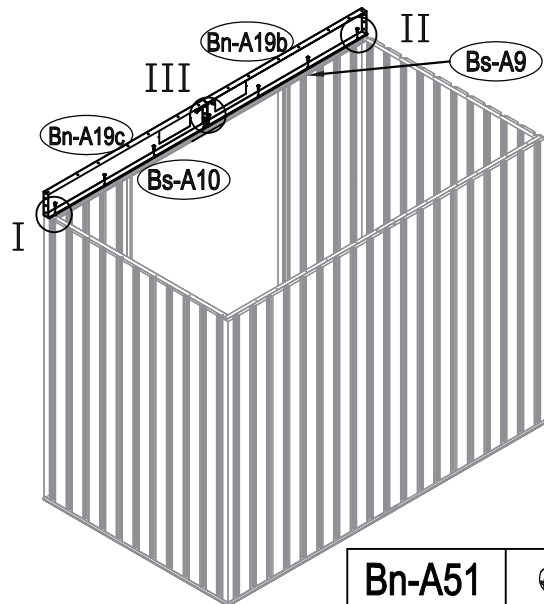
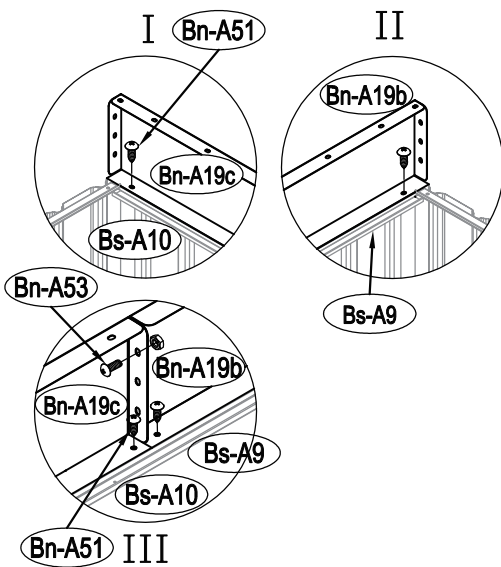

Bn-A51		x4
--------	---	----



Bn-A51		x8
Bn-A53		x1

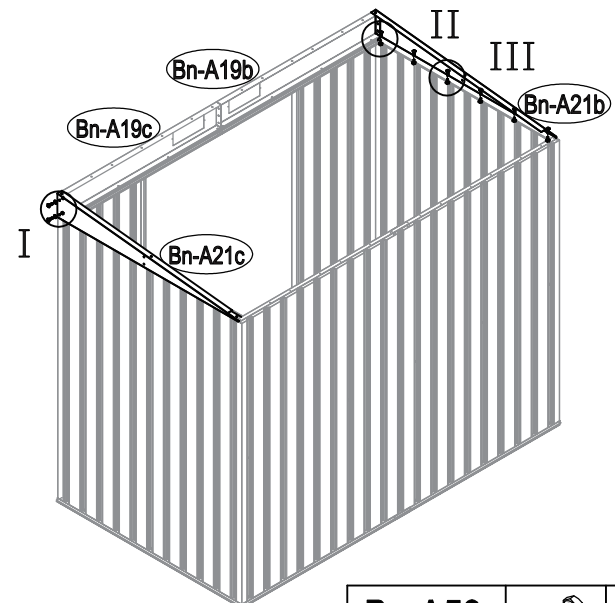
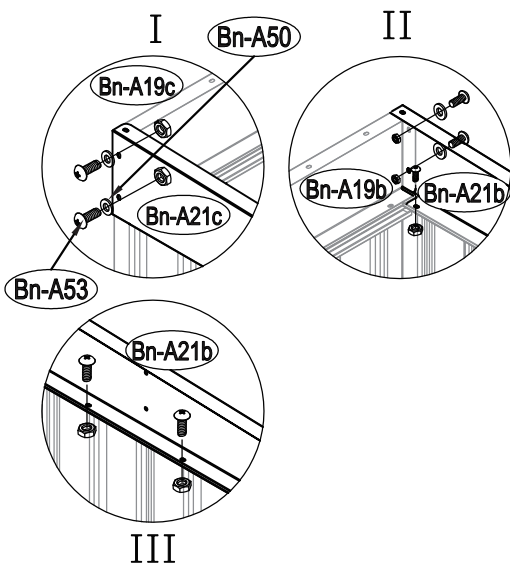

Bn-A53		x16
--------	---	-----

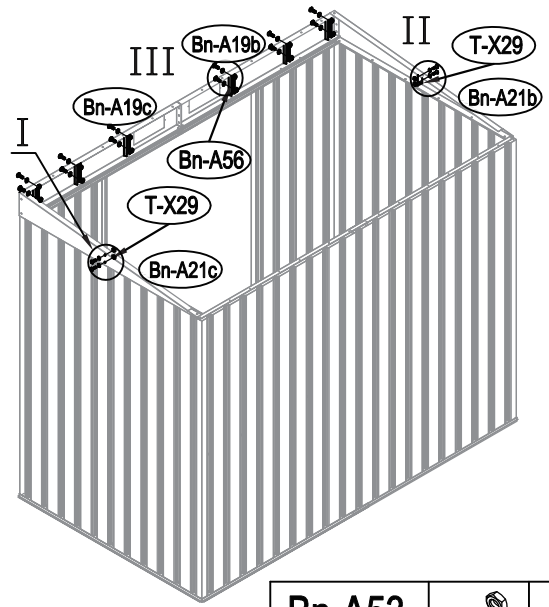
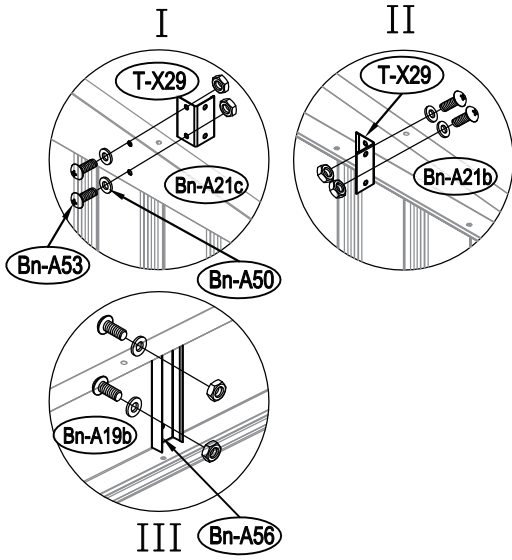

Bn-A53		x16
--------	---	-----

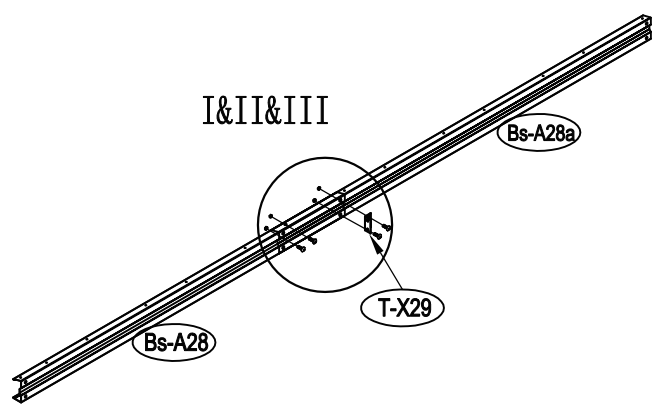
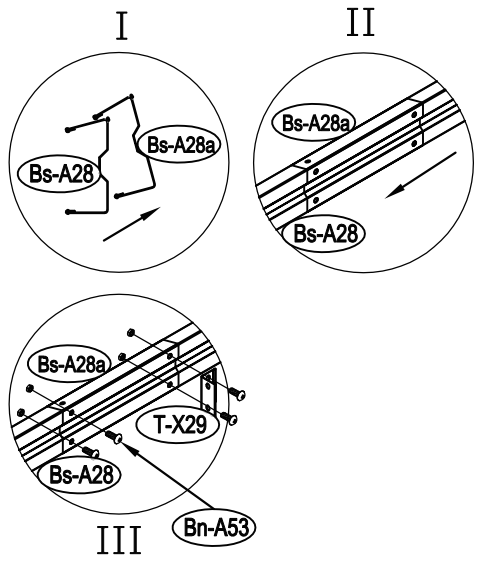

Bn-A53		x4
--------	---	----

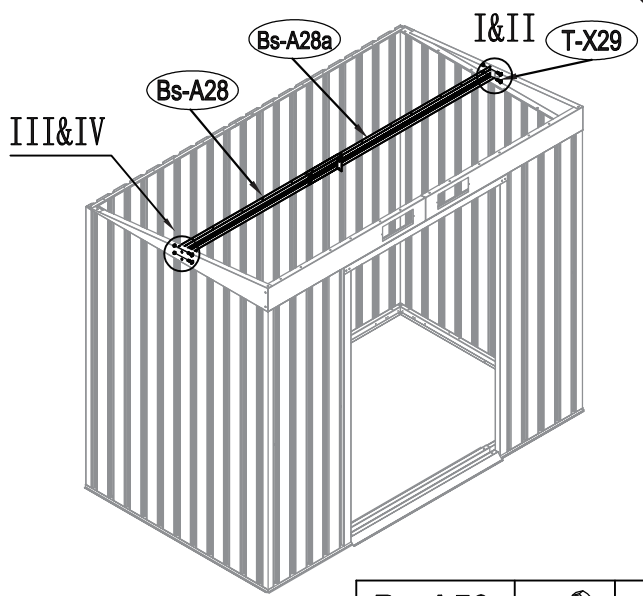
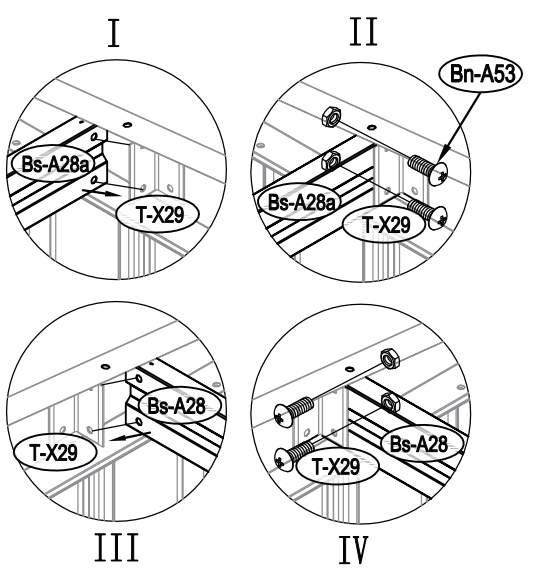

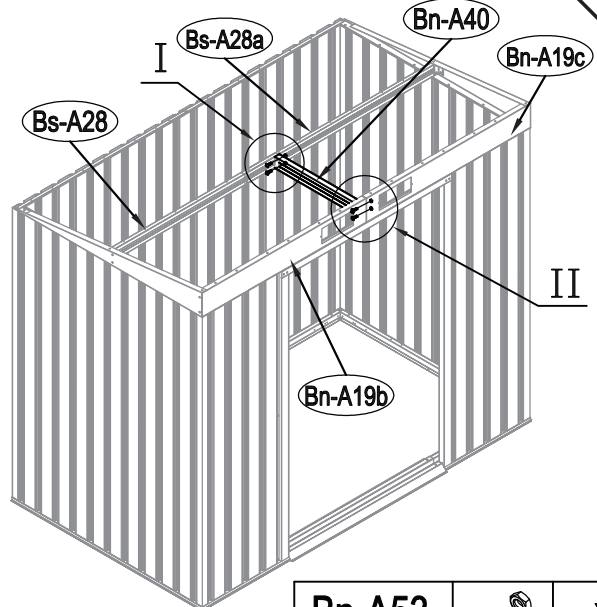
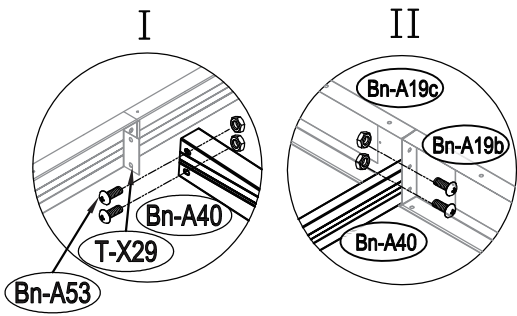

Bn-A53		x4
--------	---	----



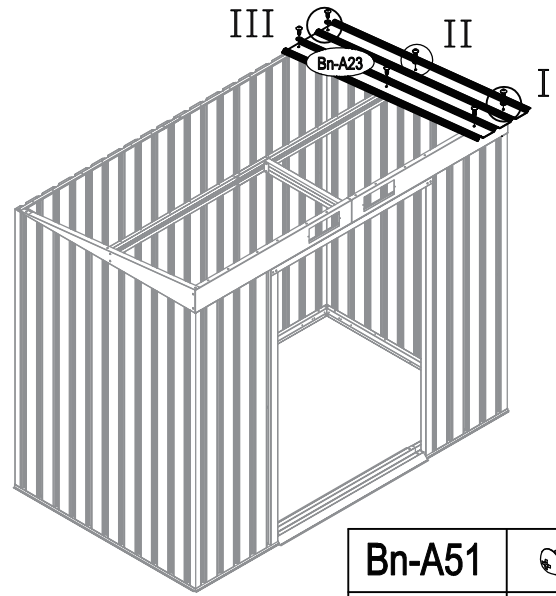
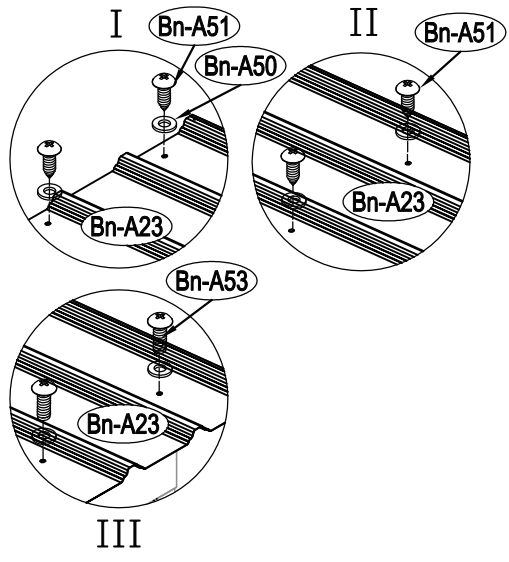

Bn-A53		x4
--------	---	----



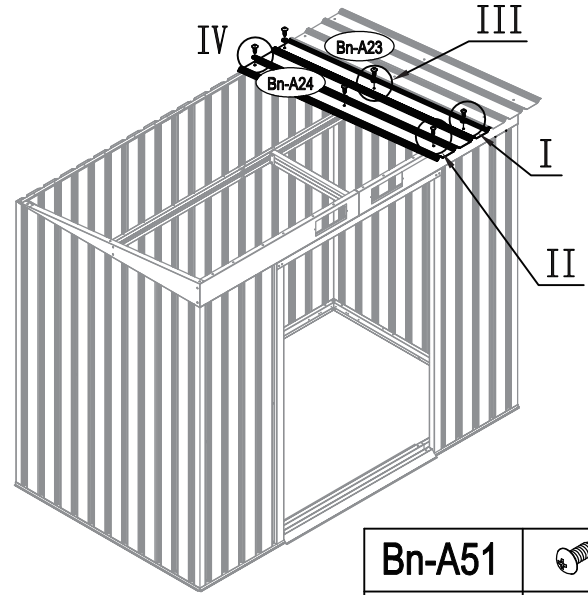
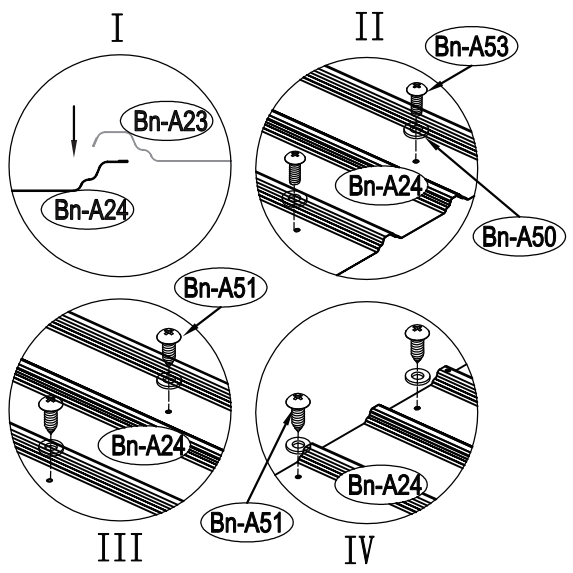

Bn-A51		x4
Bn-A53		x2



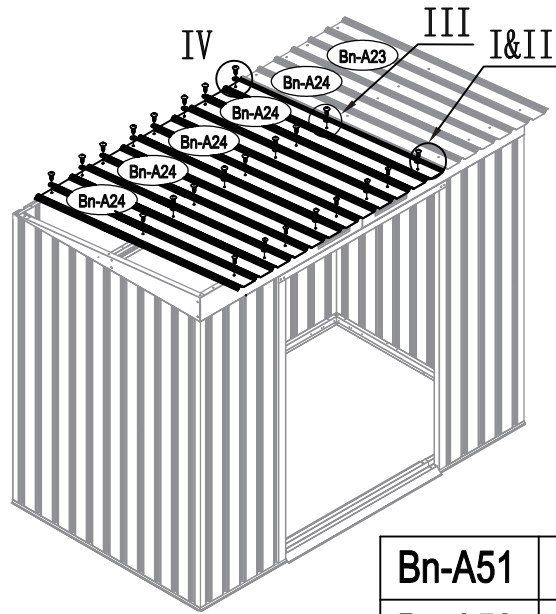
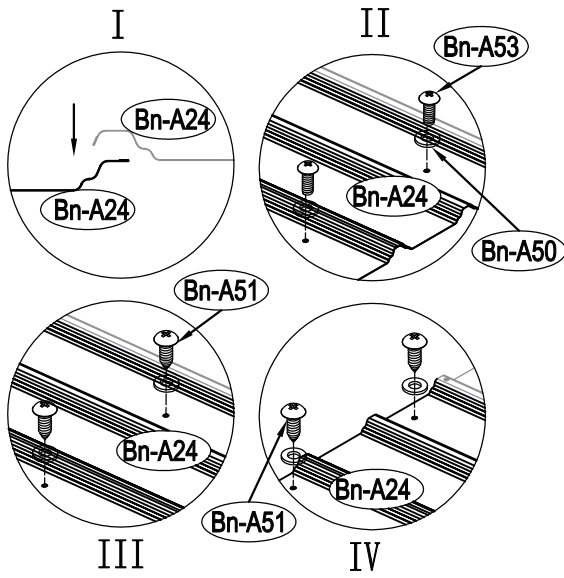

Bn-A51		x4
Bn-A53		x2

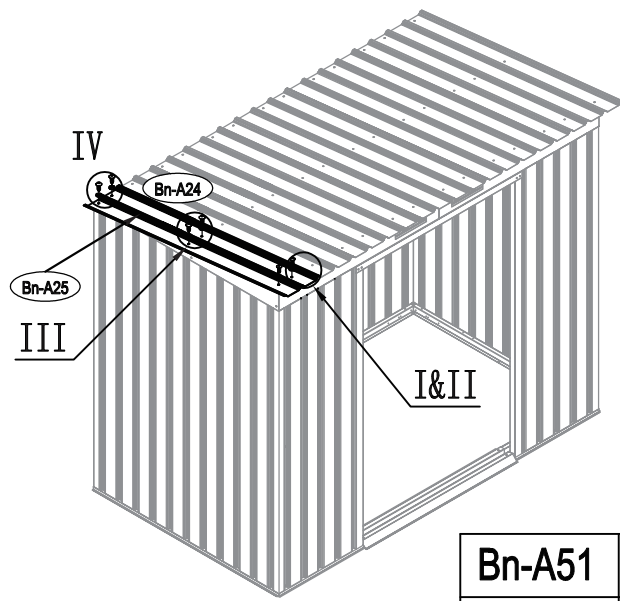
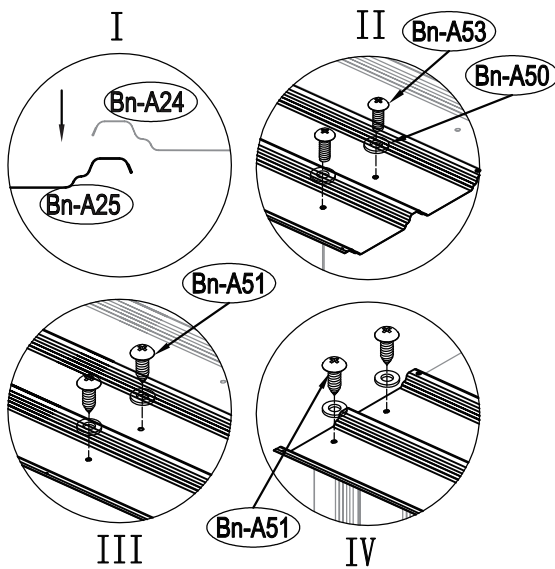

Bn-A51		x16
Bn-A53		x8



Bn-A51		x4
Bn-A53		x2

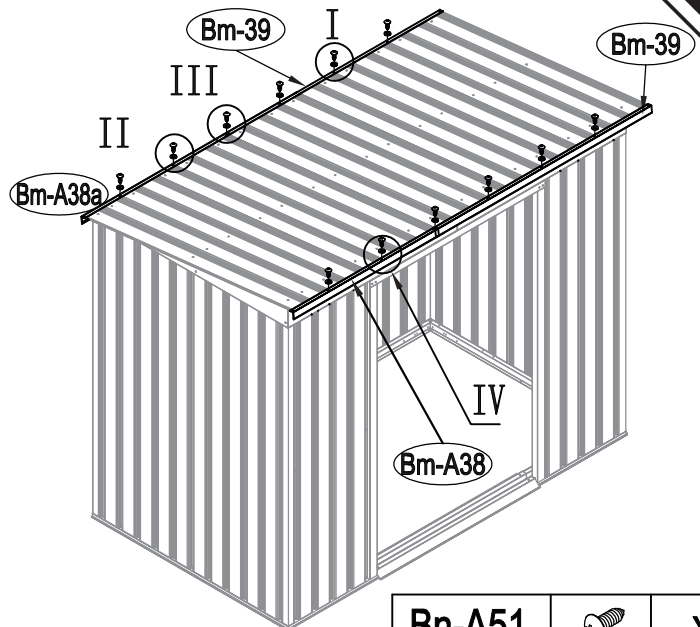
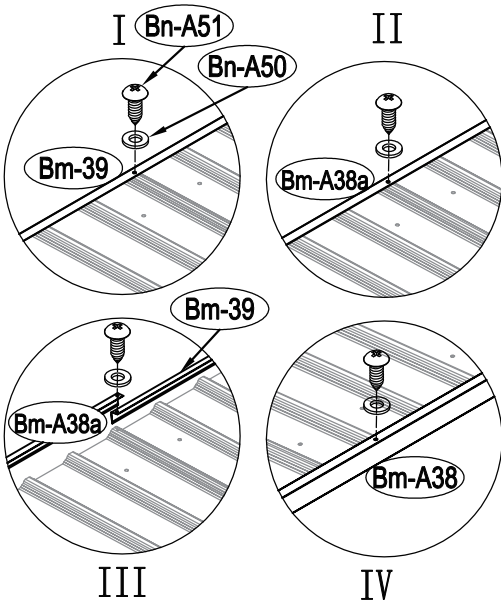

Bn-A51		x12
--------	---	-----

31

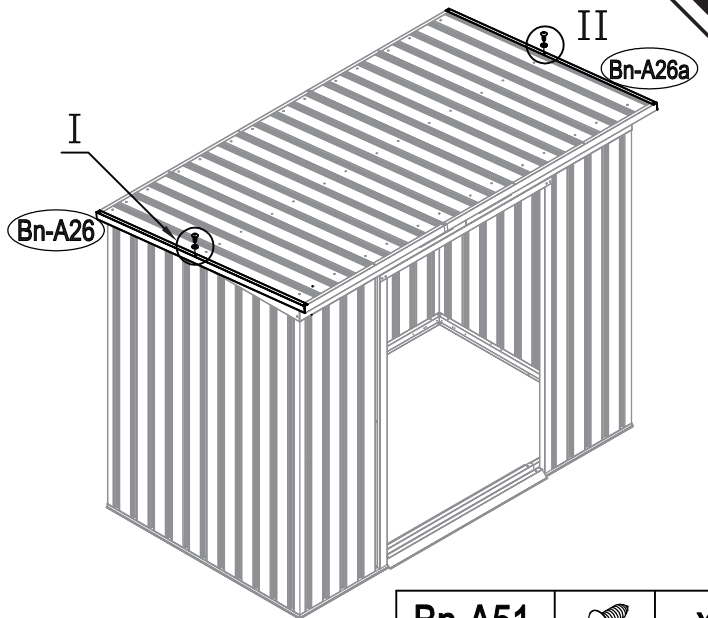
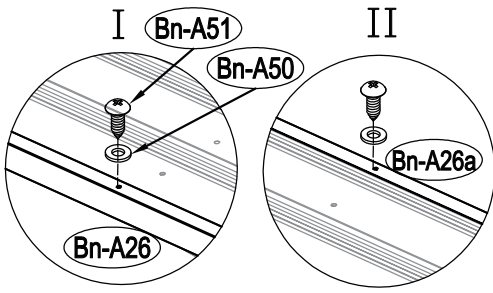

Bn-A51		x2
--------	---	----

32

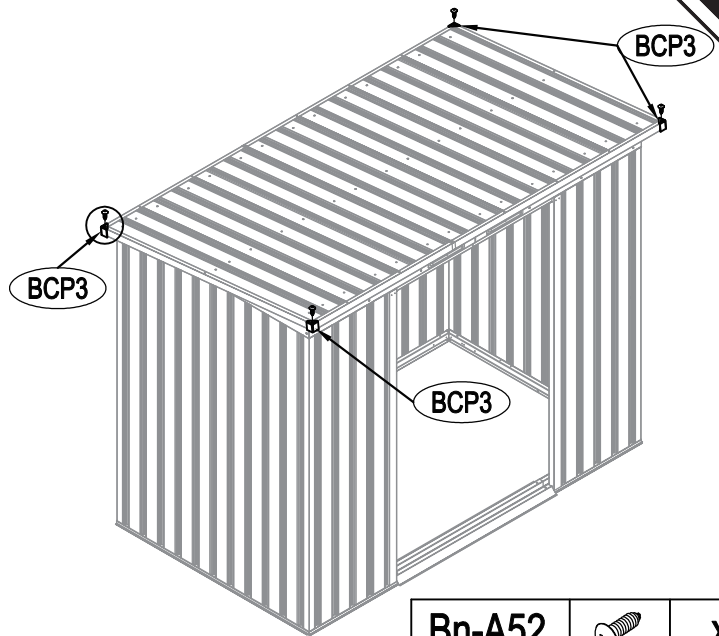
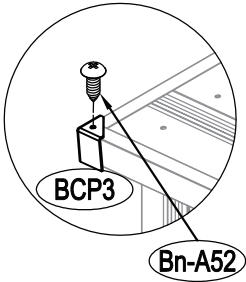

Bn-A52		x4
--------	---	----

33

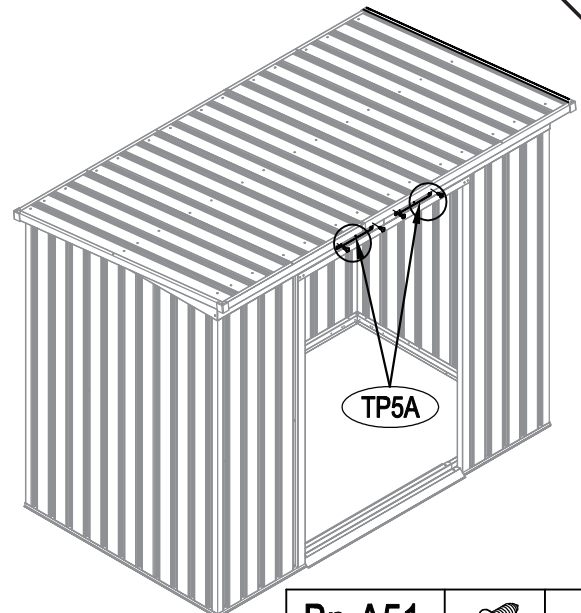
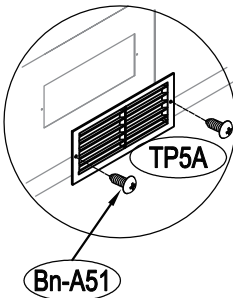

Bn-A51		x4
--------	---	----

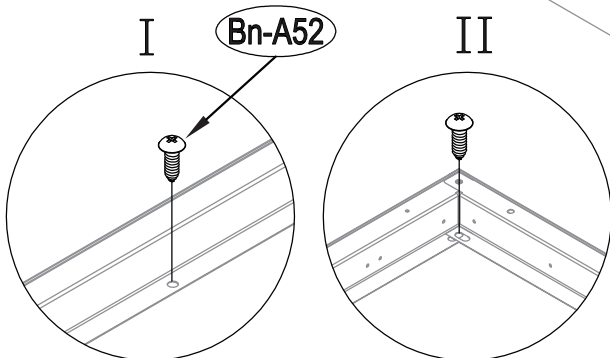
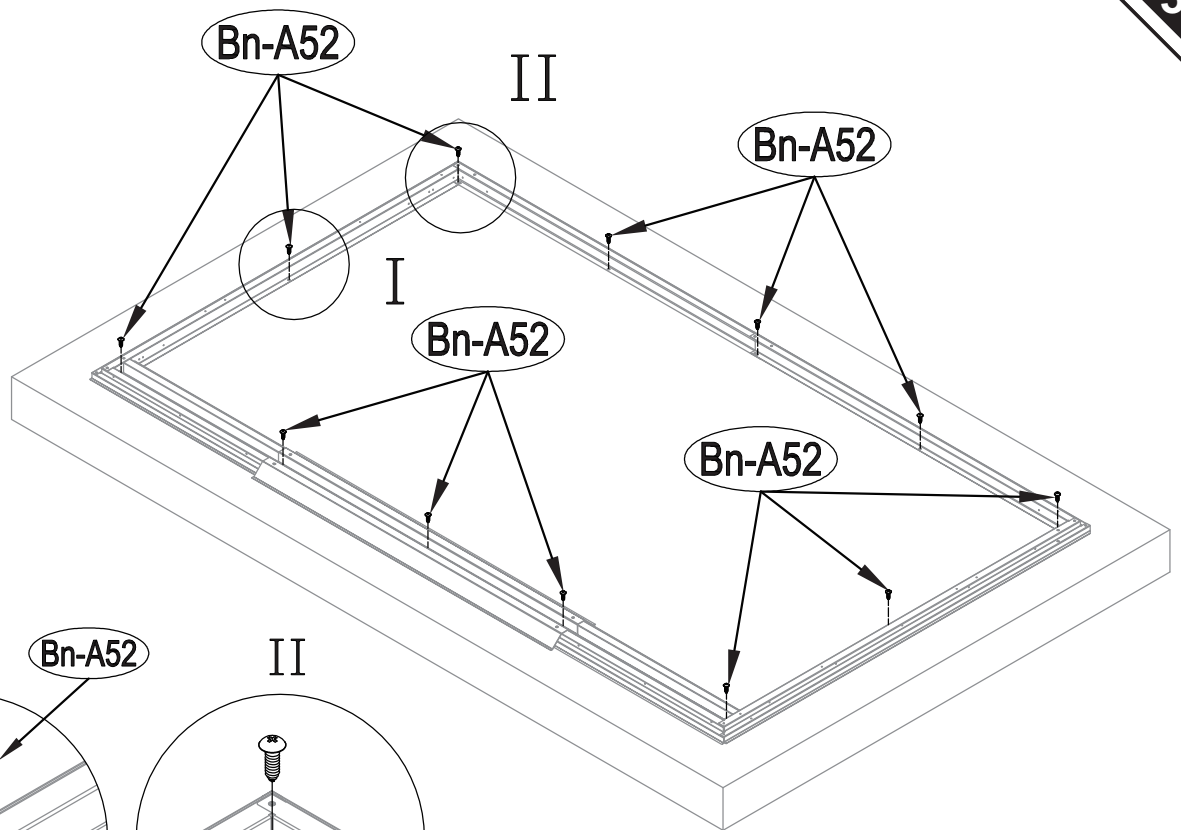
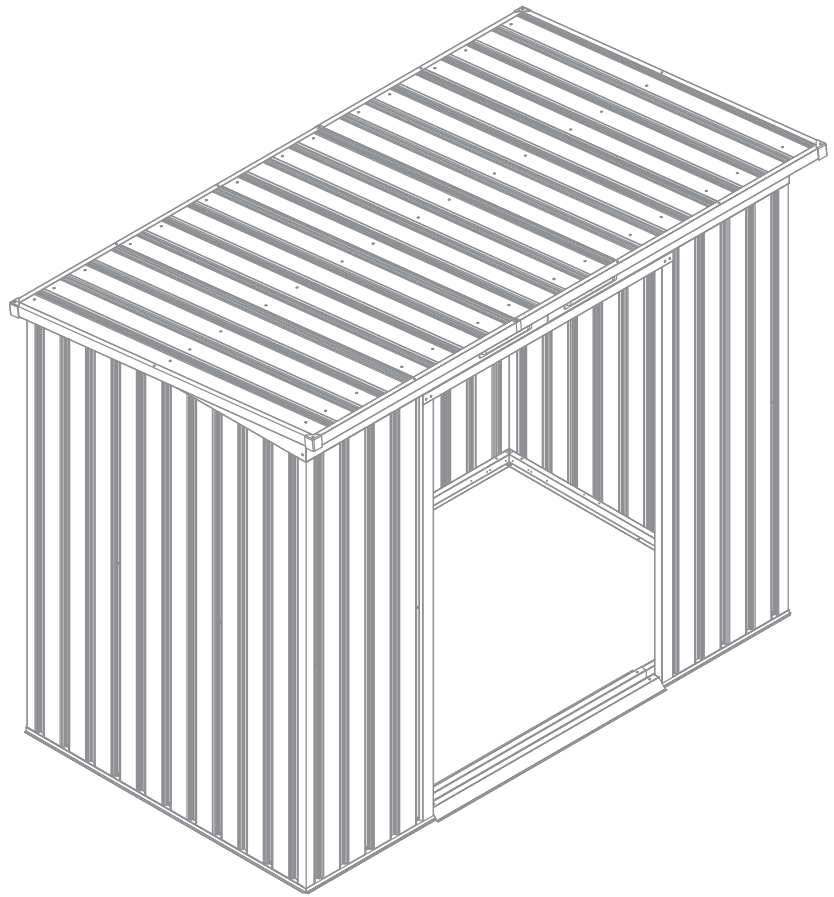
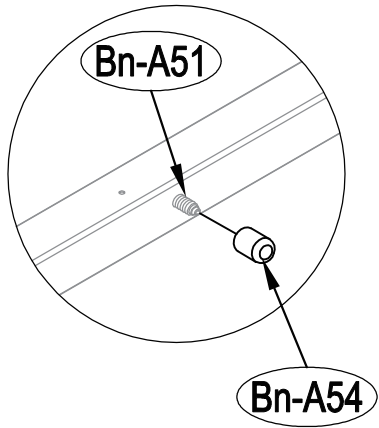



Bn-A52



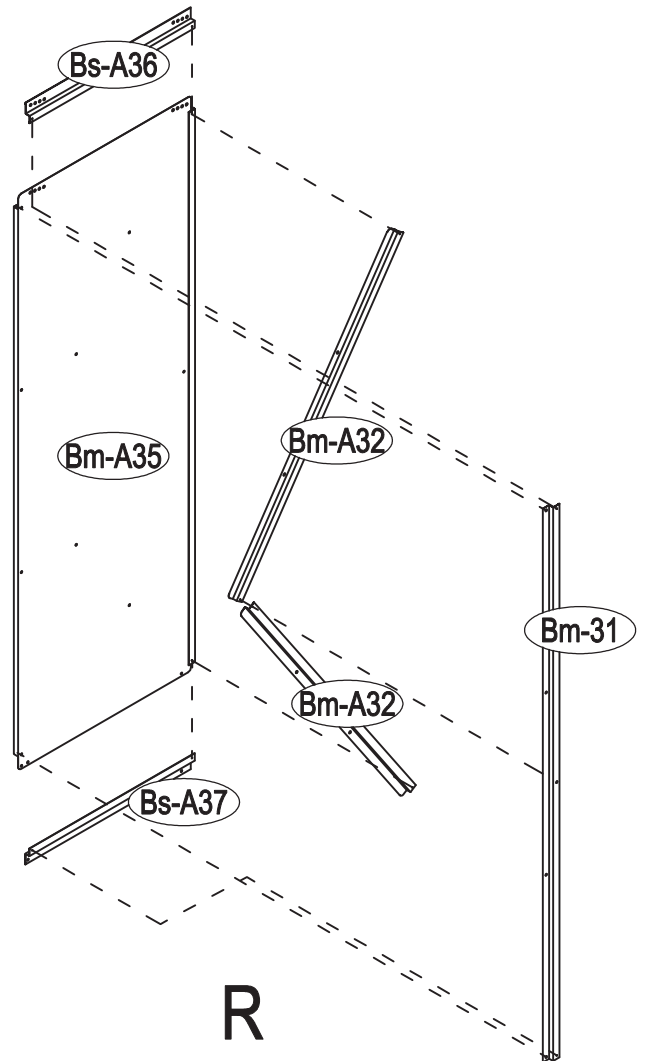
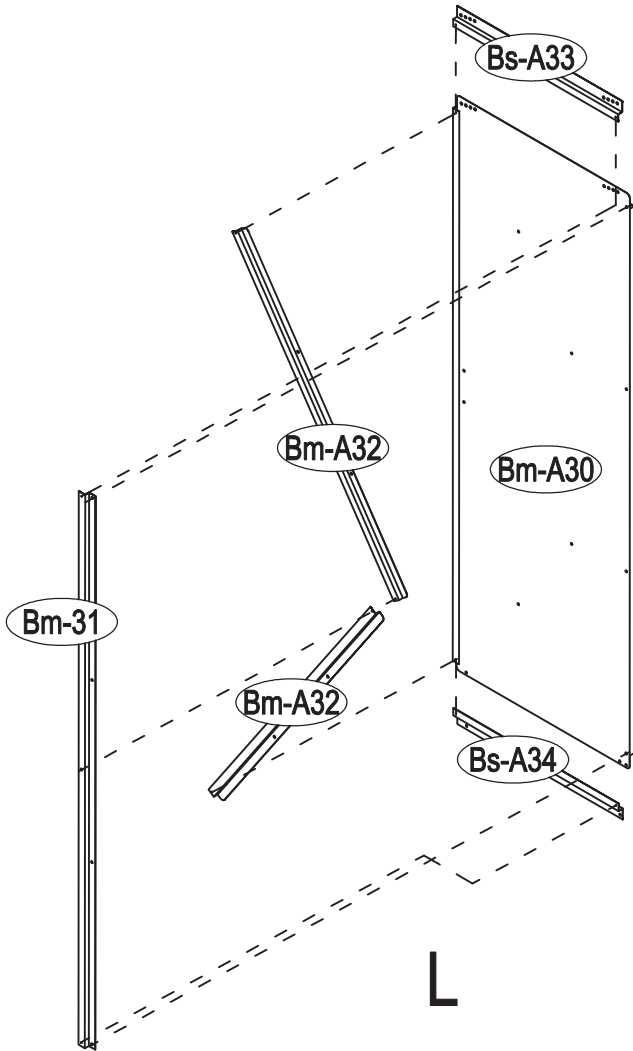

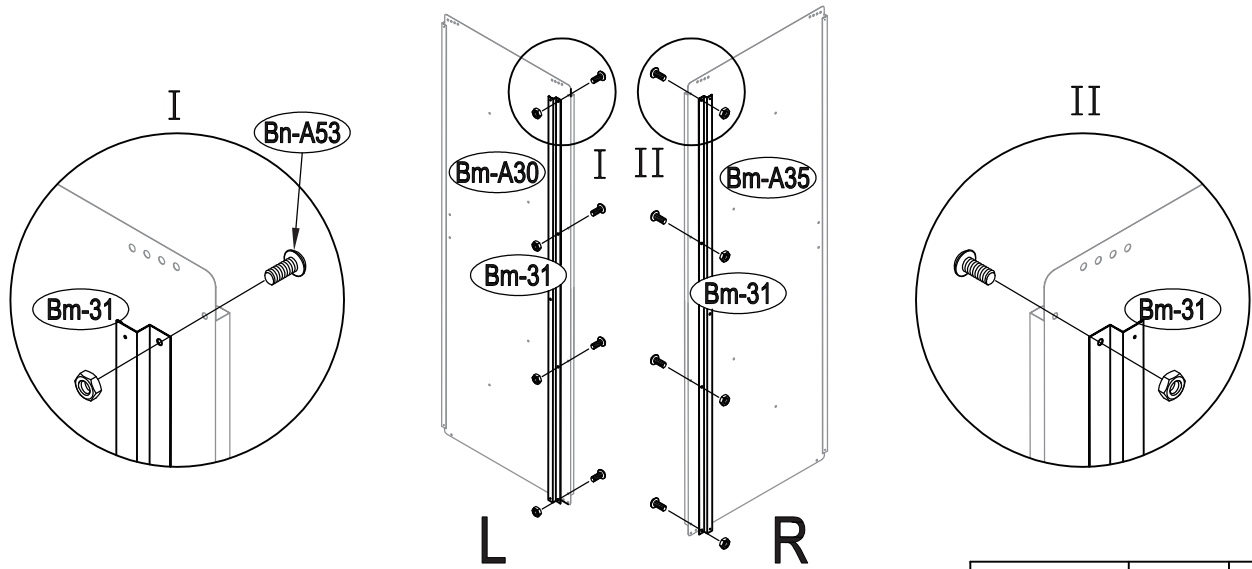
x12





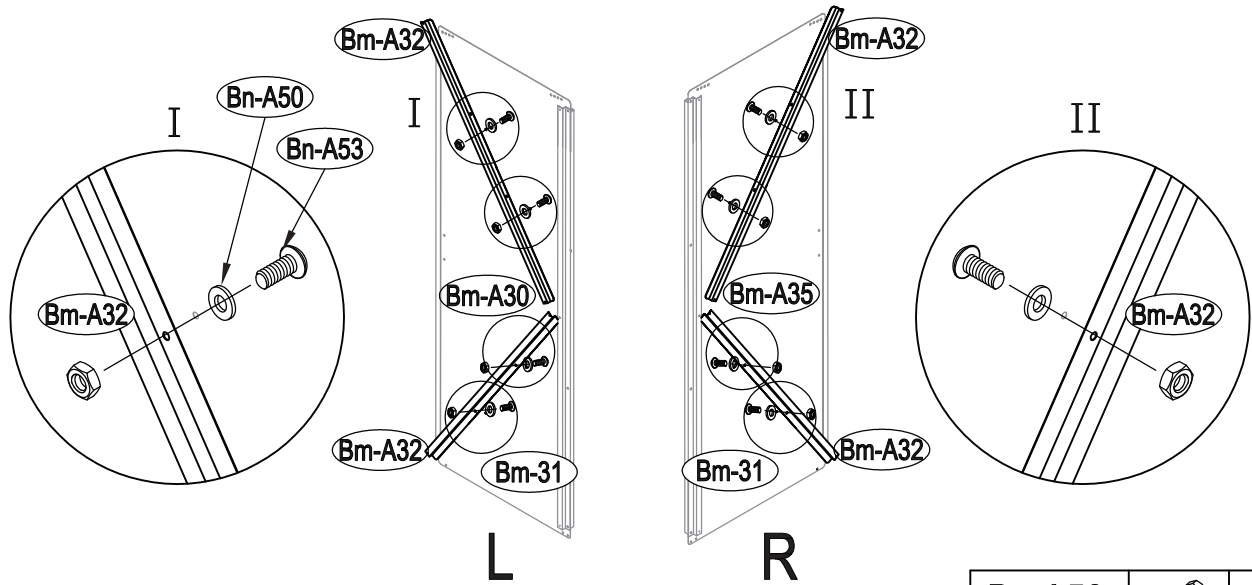

Bn-A53		x8
--------	---	----

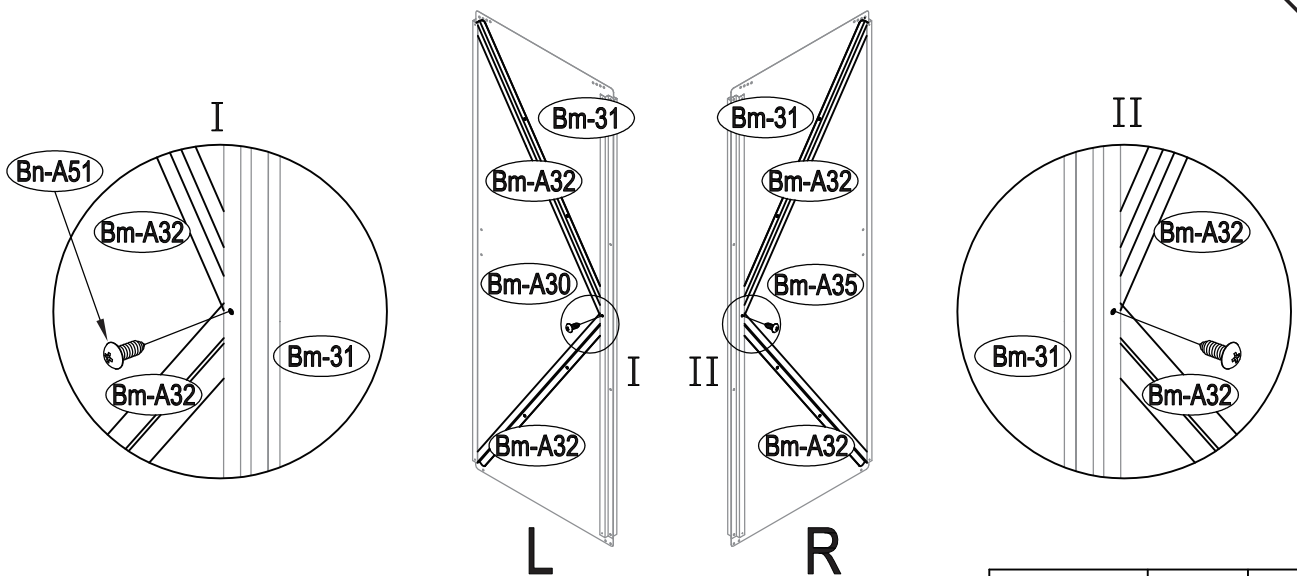

Bn-A53		x8
--------	---	----



Bn-A51		x2
--------	---	----

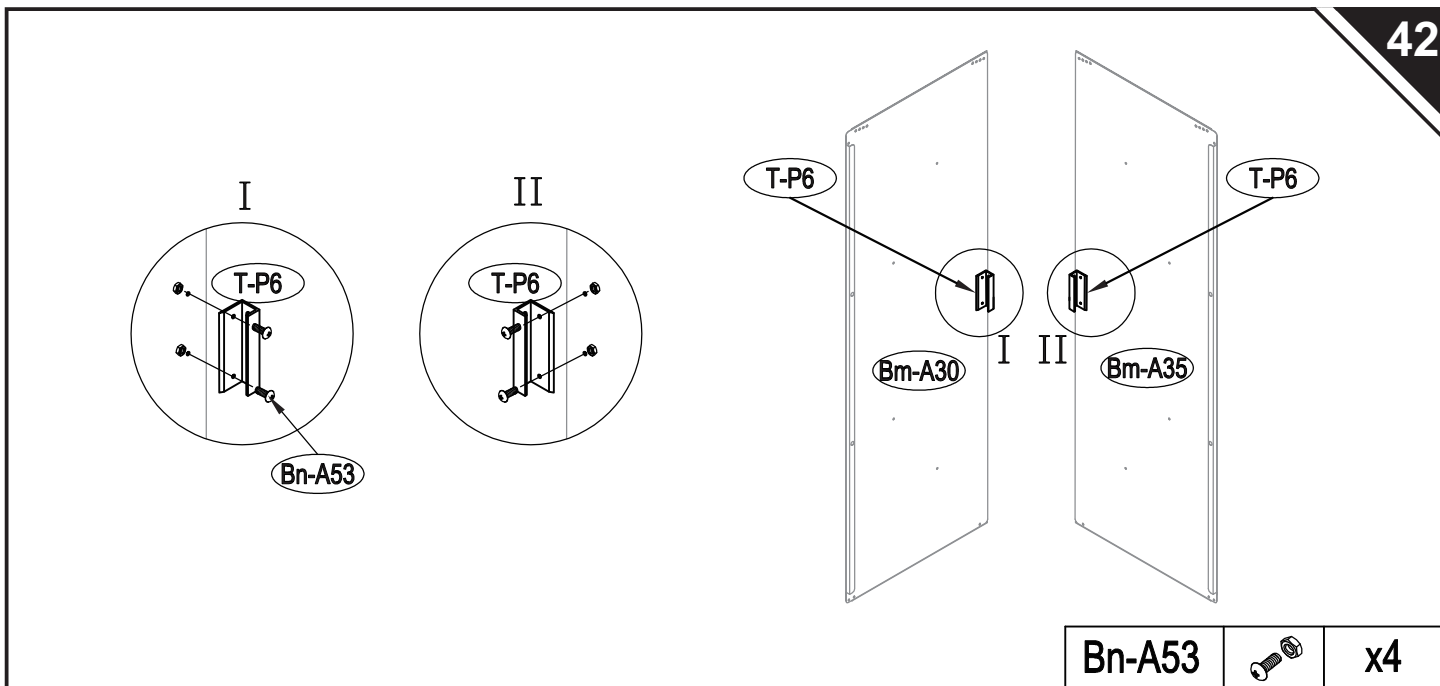
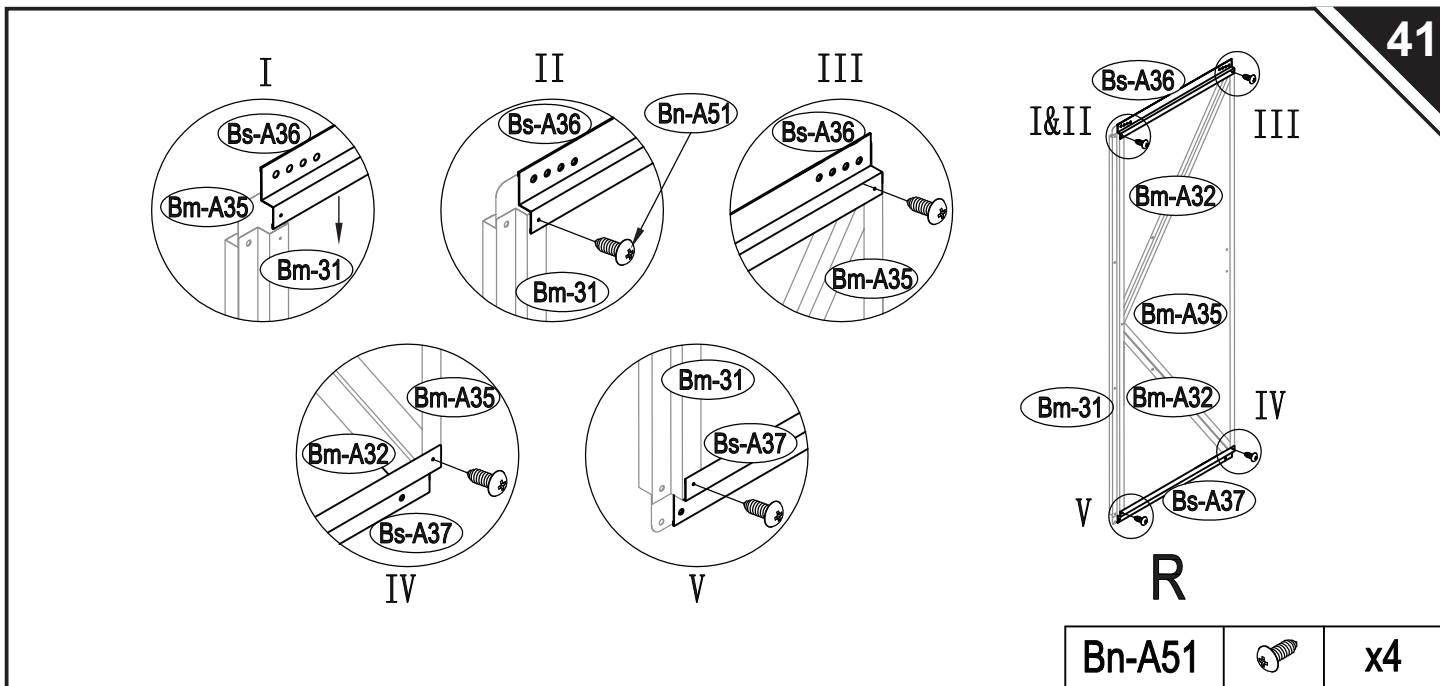
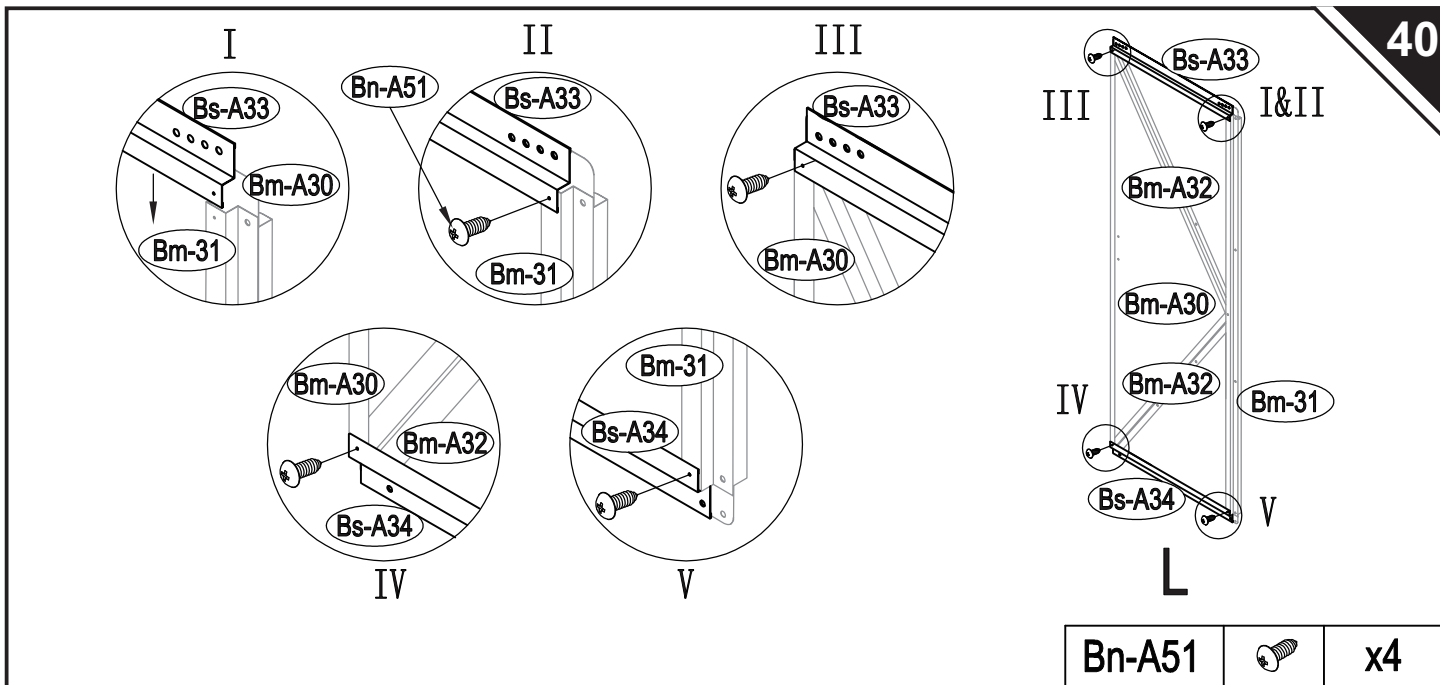

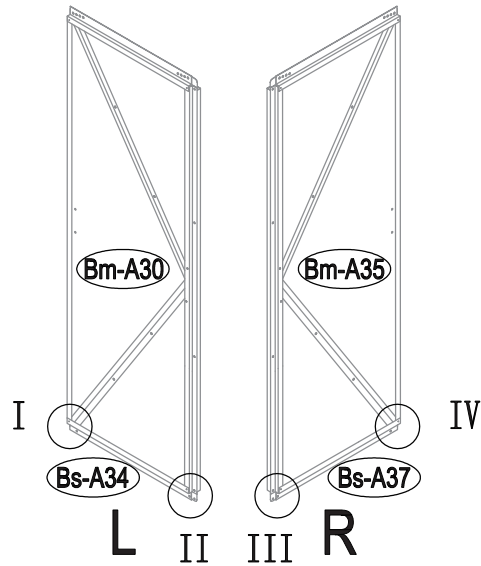
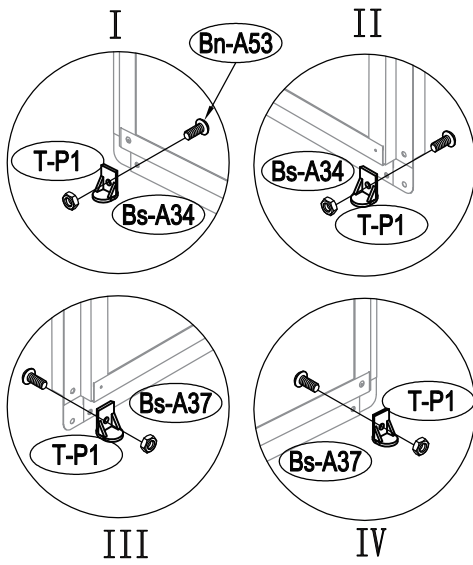

Bn-A53



x4

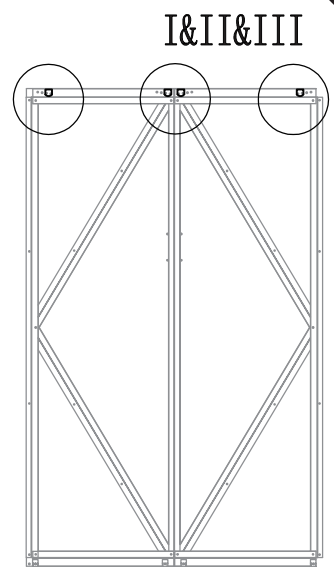
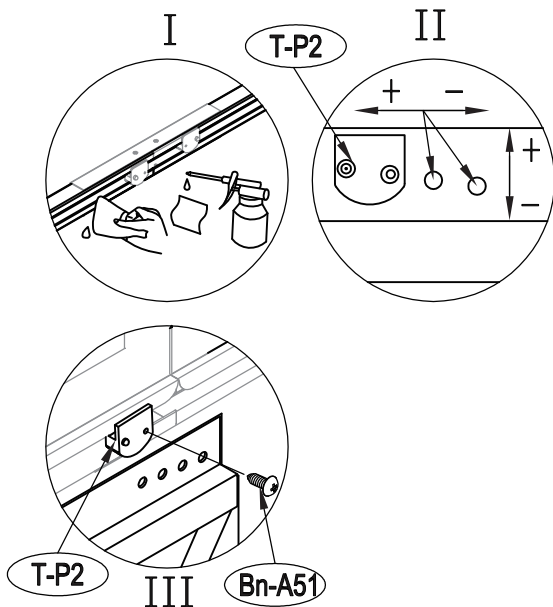
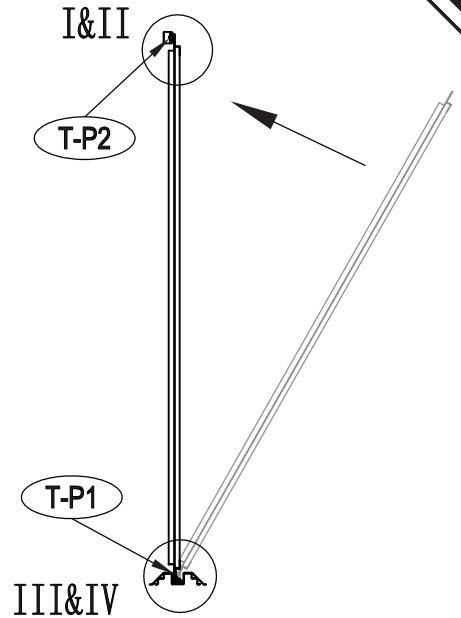
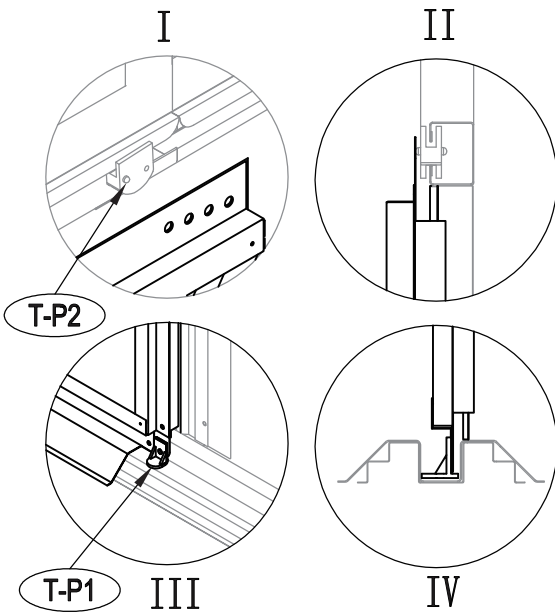

Bn-A51



x4

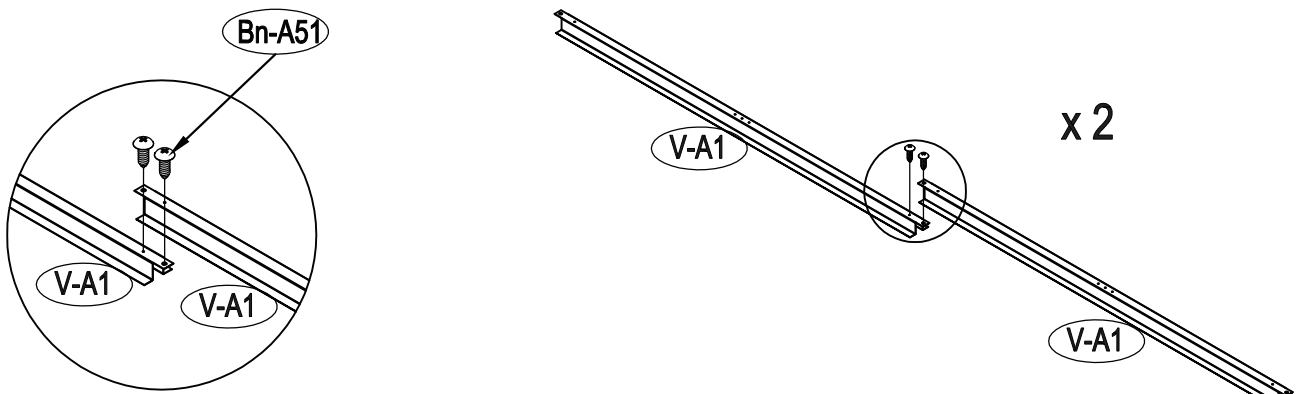
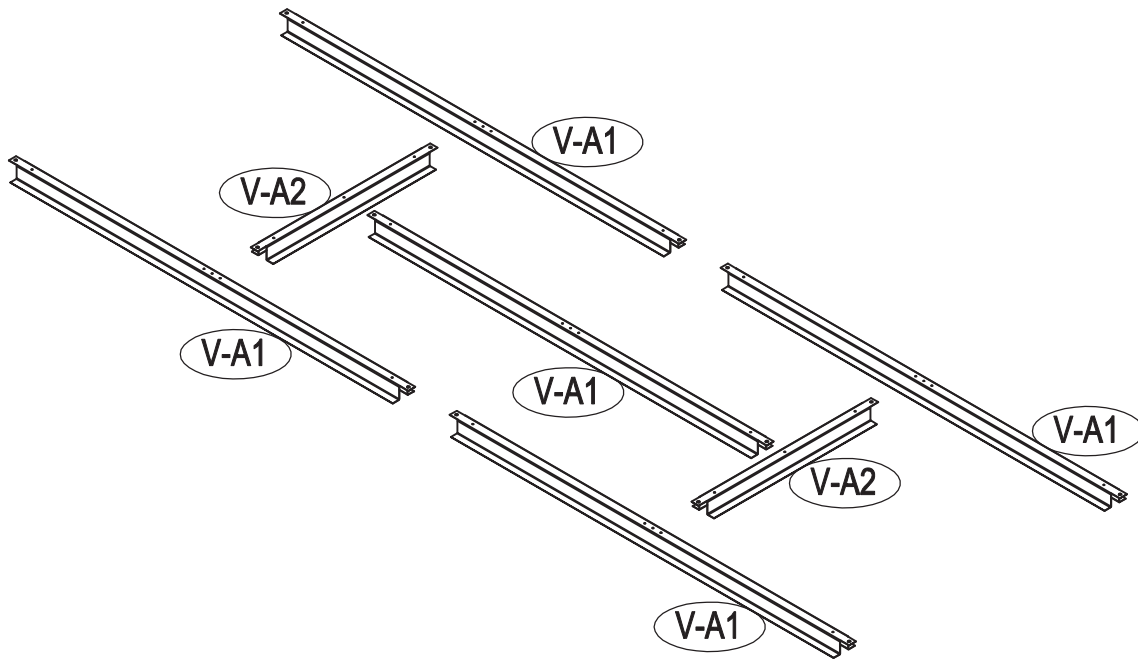

Bn-A51		x4
--------	---	----

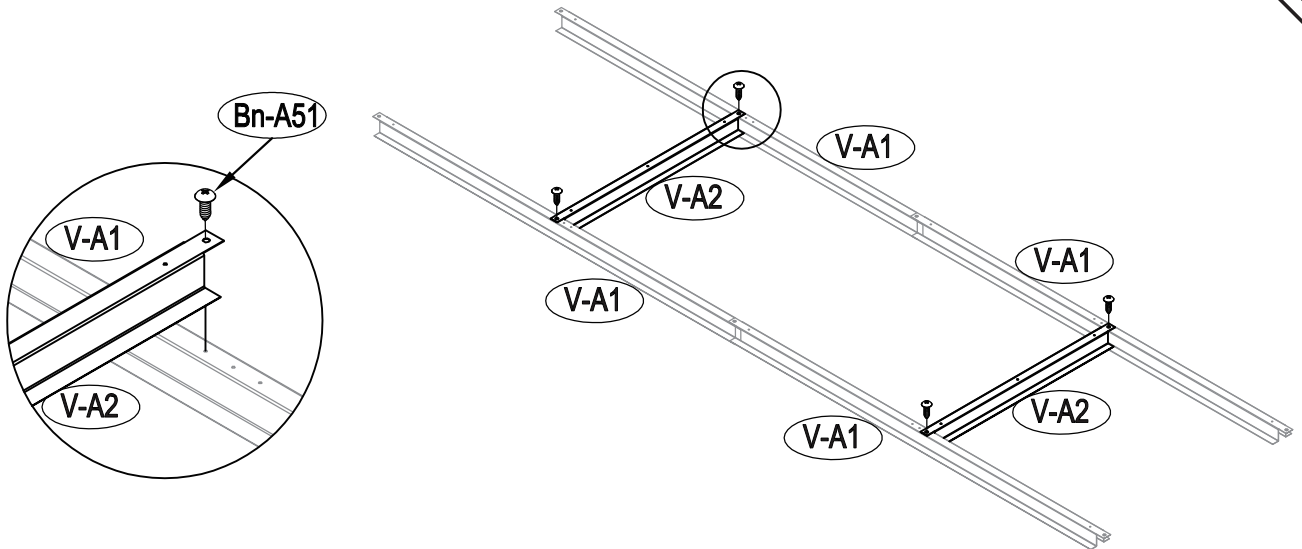

Bn-A51		x4
--------	---	----

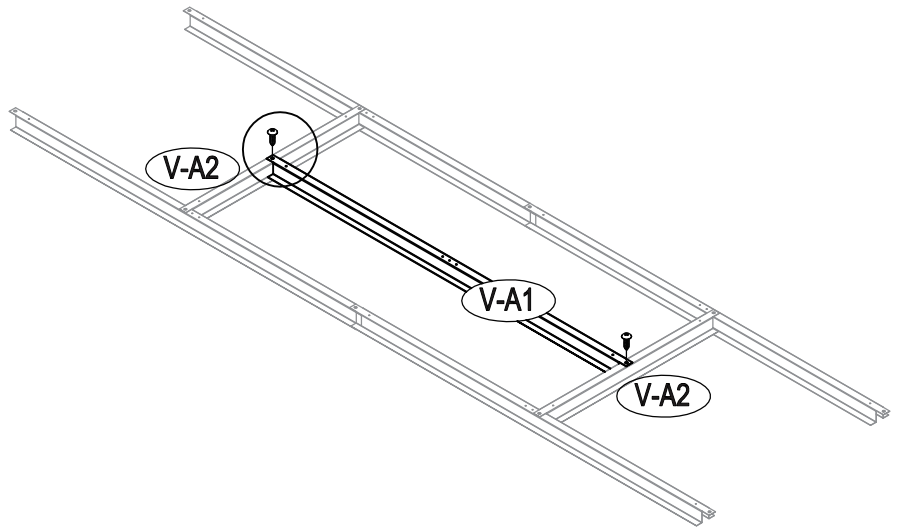
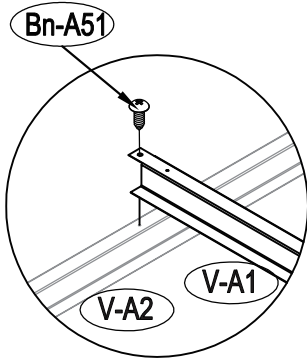

Bn-A51



x2

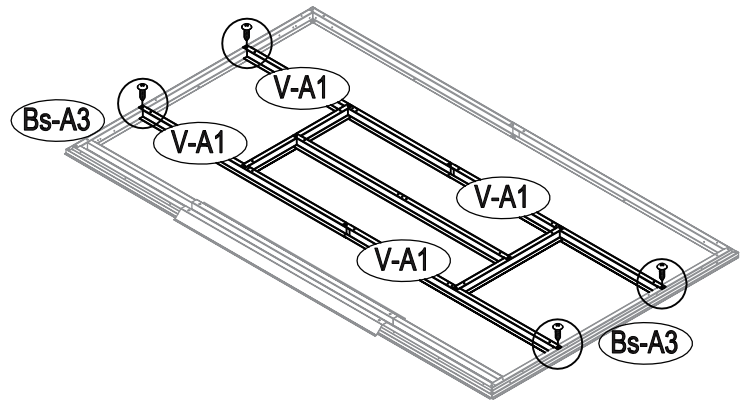
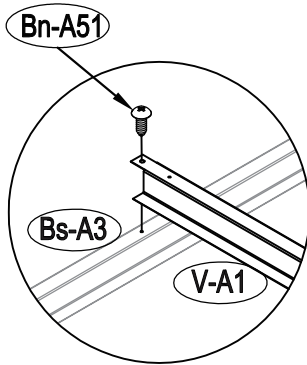

Bn-A51



x4

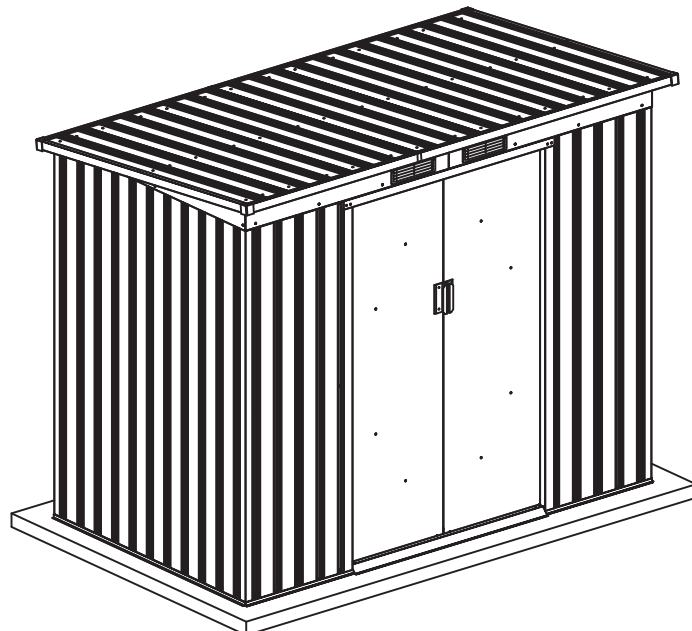

If you have any questions, please contact our customer care center, Our contact details are below:

US

 001-877-644-9366

 customerservice@aosom.com

Imported by Aosom LLC
27150 SW Kinsman Rd Wilsonville, OR 97070 USA
MADE IN CHINA

If you have any questions, please contact our customer care center, Our contact details are below:

CA

 416-792-6088

 customerservice@aosom.ca

Imported by Aosom Canada Inc.
7270 Woodbine Avenue, Unit 307, Markham,
Ontario Canada L3R 4B9
MADE IN CHINA

Si vous avez la moindre question, veuillez contacter notre centre d'assistance à la clientèle, Nos coordonnées sont les suivantes:

 416-792-6088

 customerservice@aosom.ca

Importé par Aosom Canada Inc.
7270 Woodbine Avenue, unité 307,
Markham, Ontario Canada L3R 4B9
FABRIQUÉ EN CHINE

If you have any questions, please contact our customer care center, Our contact details are below:

UK

 0044-800-240-4004

 enquiries@mhstar.co.uk

IMPORTER ADDRESS:
MH STAR UK LTD
Unit 27, Perivale Park,
Horsenden lane South
Perivale, UB6 7RH
MADE IN CHINA

Si vous avez la moindre question, veuillez contacter notre centre d'assistance à la clientèle, Nos coordonnées sont les suivantes:

FR

 0033-1-84166106

 aosom@mhfrance.fr

Importé par/Fabricant/REP:
MH FRANCE
2 Rue Maurice Hartmann
92130 Issy Les Moulineaux
France
FABRIQUÉ EN CHINE

Wenn Sie Fragen haben, wenden Sie sich bitte an unser Kundendienstzentrum, Unsere Kontaktdaten stehen unten:

DE

 0049-0(40)-87408465

 service@aosom.de

ADRESSE DES IMPORTEURE/Hersteller/REP:
MH Handel GmbH
Wendenstraße 309
D-20537 Hamburg
Germany
IN CHINA HERGESTELLT

In caso di dubbio, si prega di contattare il nostro centro assistenza clienti, I nostri dettagli di contatto sono di seguito:

IT

 0039-0249471447

 clienti@aosom.it

IMPORTATO DA/Produttore/REP:
AOSOM Italy srl
Centro Direzionale Milanofiori
Strada 1 Palazzo F1
20057 Assago (MI)
P.I.: 08567220960
FATTO IN CINA

Si tiene alguna pregunta, comuníquese con nuestro Centro de Atención al Cliente, Nuestros datos de contacto son los siguientes:

ES

 0034-931294512

 atencioncliente@aosom.es

IMPORTADOR/Fabricante/REP:
SPANISH AOSOM, S.L.
C/ROC GROS, N°15.08550, ELS HOSTALET DE
BALENYÀ, SPAIN.
B66295775
HECHO EN CHINA

Se tiver alguma dúvida, por favor contacte o nosso Centro de Atendimento ao Cliente, Os nossos dados de contacto são os seguintes:

 0034-931294512

 info@aosom.pt.

IMPORTADOR/Fabricante/REP:
SPANISH AOSOM, S.L.
C.ROC GROS N.15, 08550. ELS HOSTALET DE
BALENYÀ
FEITO NA CHINA



FR

**DONNEZ
OU
RECYCLEZ**



OU



OU



ASSOCIATION

LIVRAISON

DÉCHÈTERIE

Adresses sur quefairedemesdechets.fr