

EN\_ IMPORTANT, RETAIN FOR FUTURE REFERENCE: READ CAREFULLY.

FR\_ IMPORTANT: A LIRE ATTENTIVEMENT ET A CONSERVER POUR VOUS Y REFRERER ULTERIEUREMENT.

ES\_ IMPORTANTE, LEA DETENIDAMENTE Y GUARDE PARA FUTURAS REFERENCIAS.

PT\_ IMPORTANTE, GUARDE PARA FUTURA REFERÊNCIA, LEIA ATENTAMENTE.

DE\_ „WICHTIG! SORGFÄLTIG LESEN UND FÜR SPÄTER NACHSCHLAGEN AUFBEWAHREN.“

IT\_ IMPORTANTE, LEGGERE E CONSERVARE QUESTO MANUALE D'ISTRUZIONE PER UN USO FUTURO.

# **IMPORTANT, RETAIN FOR FUTURE REFERENCE: READ CAREFULLY.**

## **Only for domestic use**

### **Instructions for use:**

- \*Put the chair stably on a flat floor.
- \*Stay away from open flames.
- \*Avoid the overload at the chair.

### **Precautions before assembly:**

- \*Prepare a clean and dry mounting area.
- \*Verify that the product is not damaged.
- \*Check that none of the pieces are missing.

### **Maintenance:**

- \*Clean with a soft fabric.
- \*Check the seating regularly.

### **Storage conditions:**

- \*The fabric should be stored completely dry, in a clean and dry place to avoid the risks of mold.

## **Beware of crushing and cutting hazards during assembly.**

**The manufacturer declines all responsibility in case of damages due to a bad installation or withering.**

**If the seating is fitted with powered seat height adjustments, only trained personnel may replace or repair those components.**

# **IMPORTANT: A LIRE ATTENTIVEMENT ET À CONSERVER POUR CONSULTATION ULTÉRIEURE.**

## **Réservé à un usage domestique**

### **Conseils :**

- \*Placez la chaise sur un sol plat et sec afin qu'elle soit stable
- \*Placer à l'écart des flammes ou de sources de chaleur
- \*Ne pas dépasser la charge maximale autorisée

### **Précautions avant l'assemblage :**

- \*Préparez une zone de montage propre et sèche
- \*Vérifiez que le produit n'est pas endommagé
- \*Vérifiez qu'aucune des pièces de ne manque

### **Recommandations d'entretien :**

- \*Veuillez utiliser un chiffon doux pour essuyer la chaise
- \*Vérifiez régulièrement la structure du produit

### **Conditions de stockage:**

- \*Veuillez stocker le produit dans un environnement propre et sec pour éviter tout risque de moisissure.

**Veillez faire attention à ne pas vous blesser lors de l'assemblage du produit.**

**Le fabricant n'est pas responsable des dommages causés par une mauvaise installation.**

**Si le fauteuil est équipé d'un dispositif de hauteur réglable avec moteur, seule une personne qualifiée peut remplacer ou réparer la partie motorisée.**

# IMPORTANTE, LEA Y GUARDE PARA FUTURAS REFERENCIAS.

## Producto para uso doméstico

### Consejos de uso:

- \* Coloque el producto sobre un suelo plano de forma estable.
- \* Manténgase alejado de fuentes de calor y llamas.
- \* Evite la sobrecarga de los anclajes del producto.

### Precauciones antes del montaje:

- \* Prepare la zona de montaje. Asegúrese de que esté limpia y seca.
- \* Asegúrese de que el producto está en buen estado.
- \* Verifique que no falta ninguna de las piezas.

### Mantenimiento:

- \* Limpie el producto con la ayuda de un paño suave.
- \* Inspeccione el producto de forma regular a fin de detectar posibles daños o desperfectos que puedan afectar a su uso.

### Condiciones de almacenaje:

- \* A fin de evitar la aparición de moho, los tejidos se deben de guardar totalmente secos y en un lugar limpio y sin humedad.

### Atención:

**Riesgo de pinzamientos o cortes durante el montaje.**

**El fabricante declina toda responsabilidad en caso de deterioro debido a una mala instalación o por causar meteorológicas.**

**Si el producto está equipado con algún mecanismo eléctrico de ajuste de altura o similar, solo podrá ser reemplazado o reparado por personal capacitado y técnicos.**

# **IMPORTANTE, RETER PARA REFERÊNCIA FUTURA: LEIA ATENTAMENTE.**

## **Produto para uso doméstico**

### **Conselhos de uso:**

- \* Coloque o produto sobre um solo plano e estável.
- \* Mantenha-o afastado de fontes de calor e chamas.
- \* Evite a sobre carga das fixações do produto.

### **Precauções antes da montagem:**

- \* Prepare a zona de montagem. Certifique-se de que esteja limpa e seca.
- \* Certifique-se que o produto esteja em bom estado.
- \* Verifique que não falte nenhuma das peças.

### **Manutenção:**

- \* Limpar o produto com a ajuda de um pano suave.
- \* Inspeccionar o produto de forma regular a fim de detectar possíveis defeitos que possa afetar seu uso.

### **Condições de armazenamento:**

- \* A fim de evitar a aparecimento de mofo, os tecidos se devem guardar totalmente secos e em um lugar limpo e sem umidade.

### **Atenção:**

**Risco de cortes durante a montagem. O fabricante declina toda responsabilidade no caso de deterioração devido uma má instalação ou por causas meteorológicas.**

**Se o produto estiver equipado com algum mecanismo elétrico de ajuste de altura ou similar, somente poderá ser substituído ou reparado por uma pessoa qualificada ou técnicos.**

# **WICHTIG! SORGFÄLTIG LESEN UND ZUM SPÄTEREN NACHSCHLAGEN AUFBEWAHREN.**

## **Ausschließlich für den häuslichen Gebrauch bestimmt**

### **Nutzungshinweise:**

- \*Bitte stellen Sie den Stuhl stabil auf eine ebene Fläche.
- \*Von offenen Feuerquellen fernhalten.
- \*Vermeiden Sie eine Überlastung des Stuhls.

### **Vorsichtsmaßnahmen vor der Montage:**

- \*Bitte bereiten Sie einen sauberen und trockenen Montagebereich vor.
- \*Stellen Sie sicher, dass das Produkt nicht beschädigt ist.
- \*Vergewissern Sie sich, dass kein Zubehörteil fehlt.

### **Instandhaltung:**

- \*Bitte reinigen Sie den Stuhl nur mit einem weichen Tuch.
- \*Überprüfen Sie den Stuhl regelmäßig.

### **Lagerung:**

- \*Der Stoff sollte an einem völlig trockenen und sauberen Ort aufbewahrt werden, um Schimmel zu vermeiden.

### **Vorsicht vor Quetsch- und Schnittgefahr bei der Montage.**

**Der Hersteller lehnt jegliche Haftung für Schäden ab, die aufgrund unsachgemäßer Montage oder Witterungseinflüsse verursacht werden. Falls der Stuhl mit einer elektronischen Höhenverstellung geliefert wird, dürfen Reparaturarbeiten nur von qualifiziertem Personal durchgeführt werden.**

# **IMPORTANTE! CONSERVARE IL PRESENTE MANUALE PER FUTURO RIFERIMENTO E LEggerLO ATTENTAMENTE.**

## **Solo per uso domestico**

### **Istruzioni per l'uso:**

\*Posizionare la sedia in maniera stabile su un pavimento in piano.

\*Tenere lontano dalle fiamme vive.

\*Evitare di sovraccaricare la sedia.

### **Precauzioni prima del montaggio:**

\*Preparare un'area di montaggio sgombra e asciutta.

\*Verificare che il prodotto non sia danneggiato.

\*Verificare che non manchi nessun pezzo.

### **Manutenzione:**

\*Pulire con un tessuto morbido.

\*Controllare regolarmente il sedile.

### **Condizioni di stoccaggio:**

\*Il tessuto deve essere conservato completamente asciutto, in un luogo pulito e asciutto per evitare la formazione di muffa.

**Fare attenzione al rischio di schiacciamento e di taglio durante le fasi di montaggio.**

**Il produttore declina ogni responsabilità in caso di danni dovuti ad un'installazione incorretta o alle intemperie.**

**Se la sedia è dotata di un'unità di regolazione elettrica dell'altezza del sedile, solo il personale qualificato può sostituire o riparare questi componenti elettrici.**

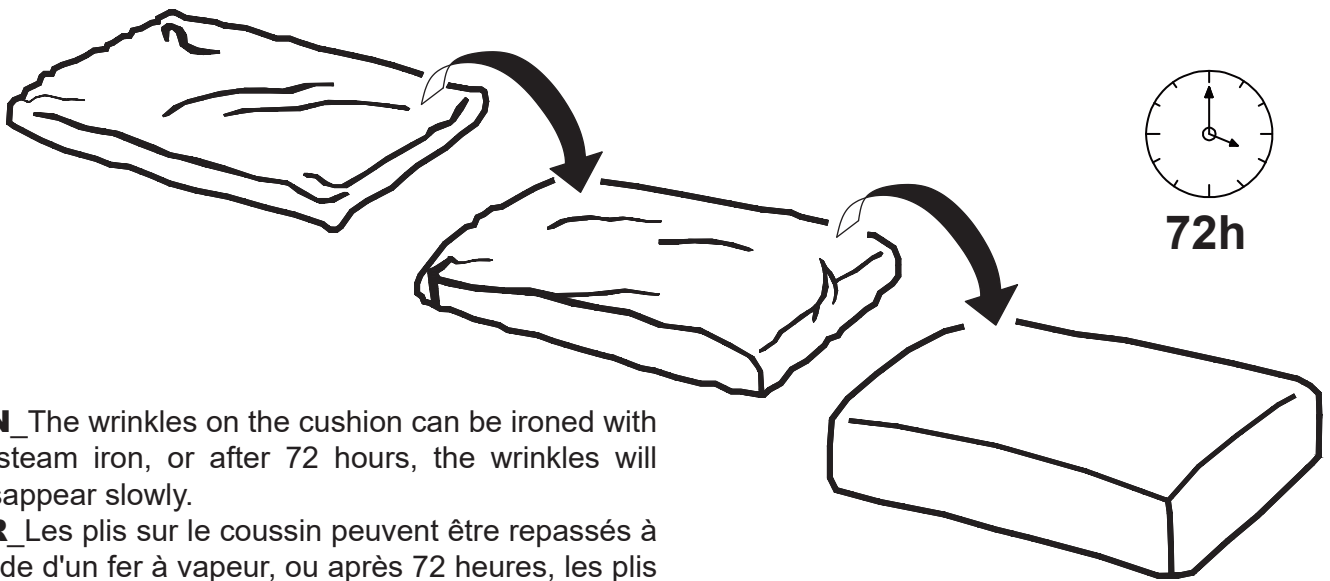
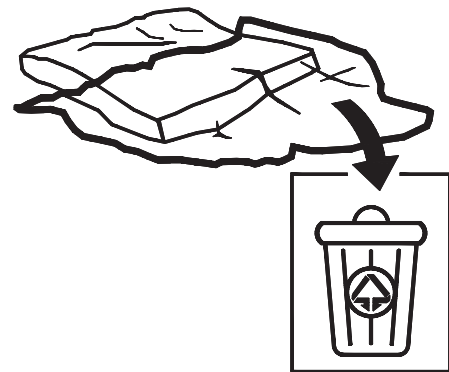
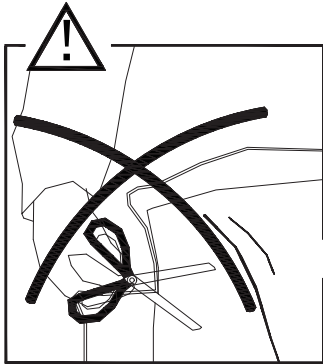
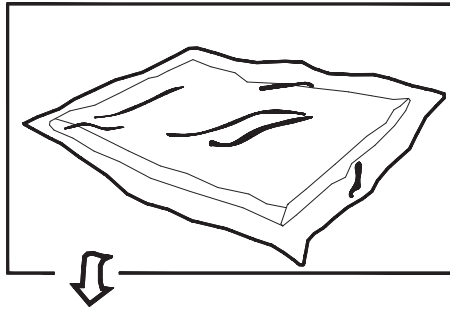

**EN** The wrinkles on the cushion can be ironed with a steam iron, or after 72 hours, the wrinkles will disappear slowly.

**FR** Les plis sur le coussin peuvent être repassés à l'aide d'un fer à vapeur, ou après 72 heures, les plis disparaîtront lentement.

**DE** Die Falten auf dem Kissen können mit einem Dampfbügeleisen gebügelt werden, oder nach 72 Stunden, werden die Falten langsam verschwinden.

**ES** Las arrugas del cojín se pueden planchar con una plancha de vapor, o desaparecerán lentamente después de 72 horas.

**PT** Pode-se passar as almofadas para remover o amassado usando ferro a vapor ou, após 72 horas, o amassado desaparece lentamente.

**IT** Le pieghe sul cuscino possono essere stirate con un ferro da stiro a vapore, oppure dopo 72 ore le pieghe scompariranno lentamente.

**EN** Make the backrest pillows fuller by tapping and squeezing them.

**FR** Rendez les coussins du dossier davantage pleins en les tapotant et en les pressant.

**DE** Die Kissen der Rückenlehne werden durch Klopfen und Zusammendrücken fülliger.

**ES** Hágalos más llenos golpeando y apretando los cojines del respaldo.

**PT** Bata e aperte as almofadas do encosto para deixá-las mais cheias.

**IT** Rendere i cuscini del supporto schienale più pieni battendoli e stringendoli.

## PARTS

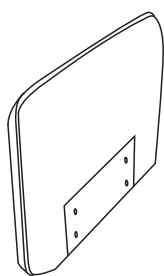
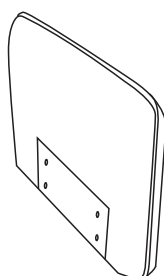
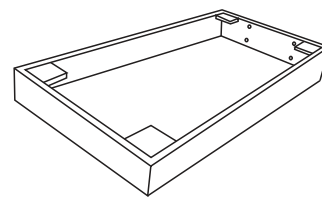
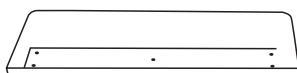
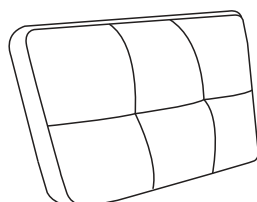
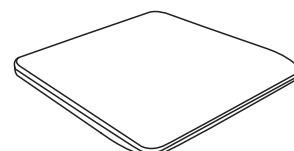
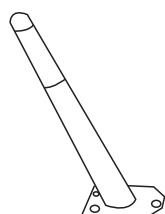
**A** x 1**B** x 1**C** x 1**D** x 1**E** x 2**F** x 2**G** x 4

## HARDWARE

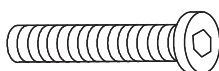
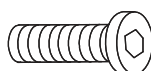
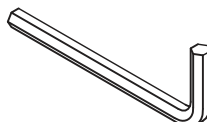
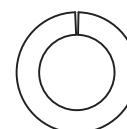
**1** x13  
M8\*45  
+3 (spare)**2** x12  
M6\*25  
+3 (spare)**3** x13  
M8\*22  
+3 (spare)**4** x 1  
4mm**5** x 1  
5mm**6** x13  
12mm  
+3 (spare)

**EN**\_Do not confuse similar screws. Do not tighten bolts fully until all parts are connected!

**FR**\_Ne pas confondre des vis similaires. Ne serrez pas les boulons à fond tant que toutes les pièces ne sont pas connectées!

**ES**\_No confunda tornillos similares. No apriete los tornillos completamente hasta que todas las partes están conectadas!

**PT**\_Não confundir parafusos semelhantes. Não apertar completamente os parafusos até que todas as peças estejam encaixadas!

**DE**\_Verwechseln Sie ähnliche Schrauben nicht. Ziehen Sie die Schrauben erst fest an, wenn alle Teile verbunden sind!

**IT**\_Non confondere le viti simili. non serrare completamente i bulloni fino a tutte le parti non sono ancora collegate!

## NOTE

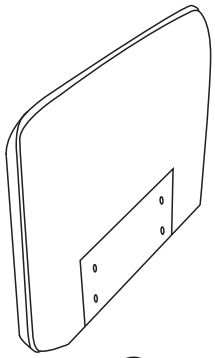

A

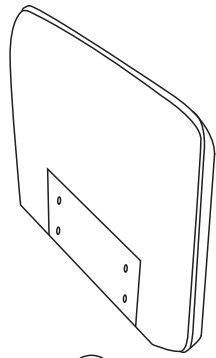

B

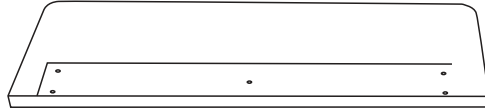

D

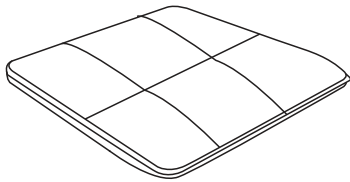

E x 2

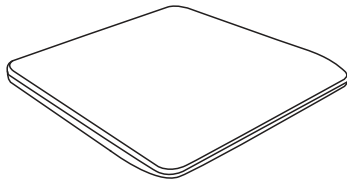

F x 2

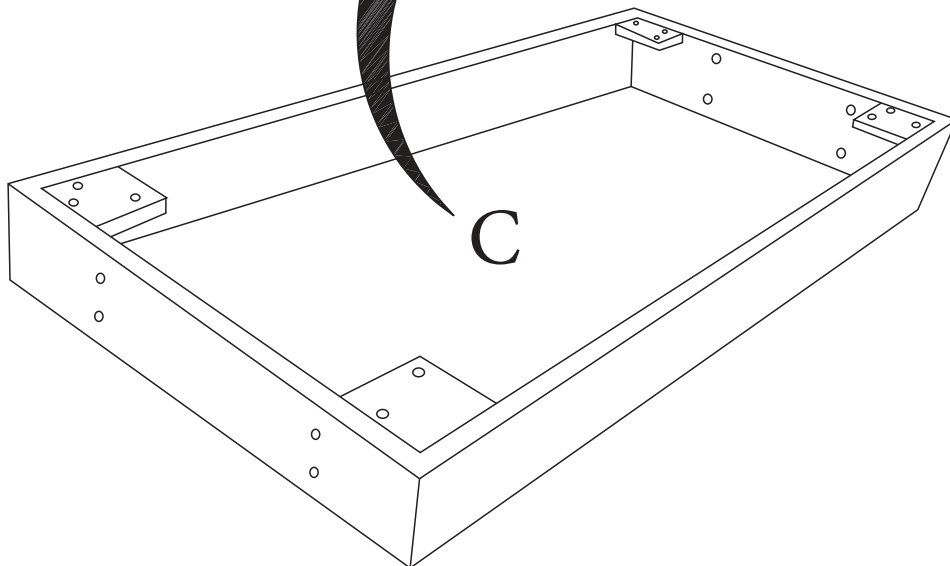
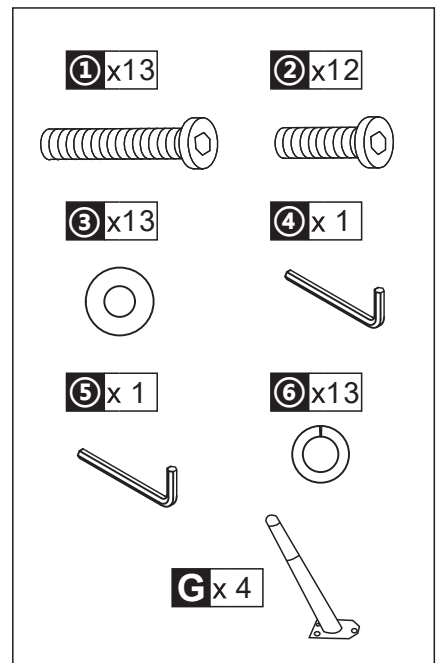

1 X 5

3 X 5 6 X 5

5 X 1

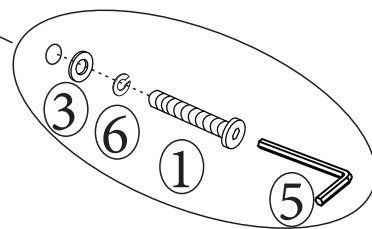
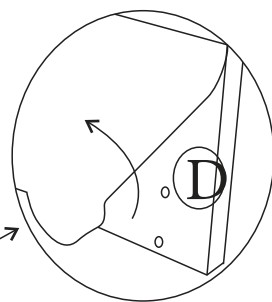
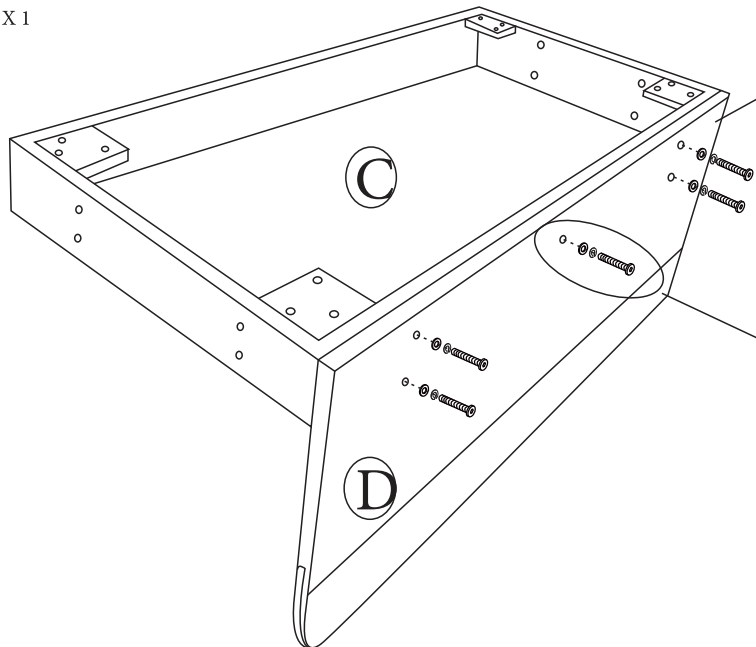

1 X 8

3 X 8 6 X 8

5 X 1

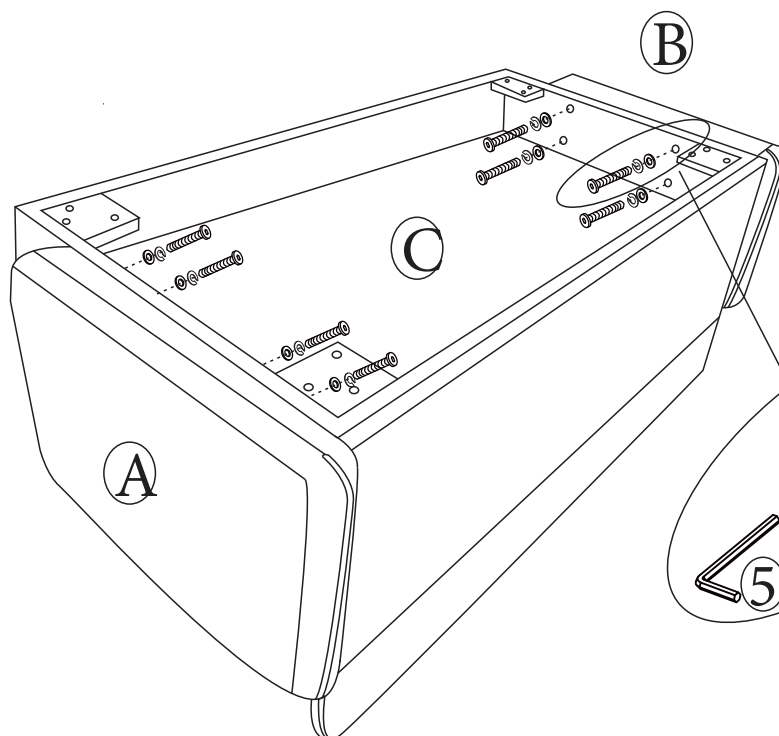



B

C

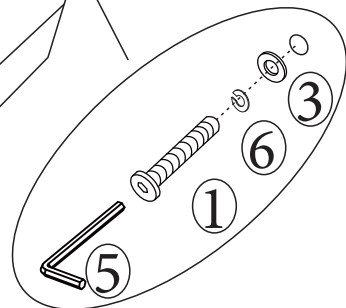
A

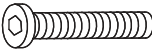

2  X 12

4  X 1

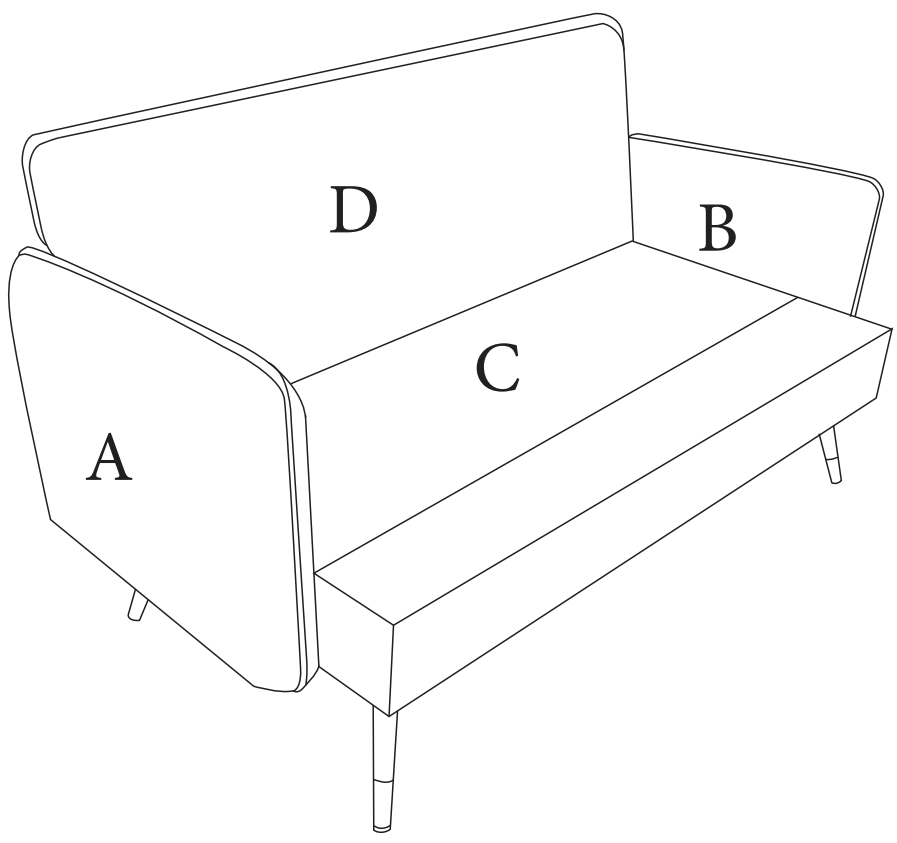
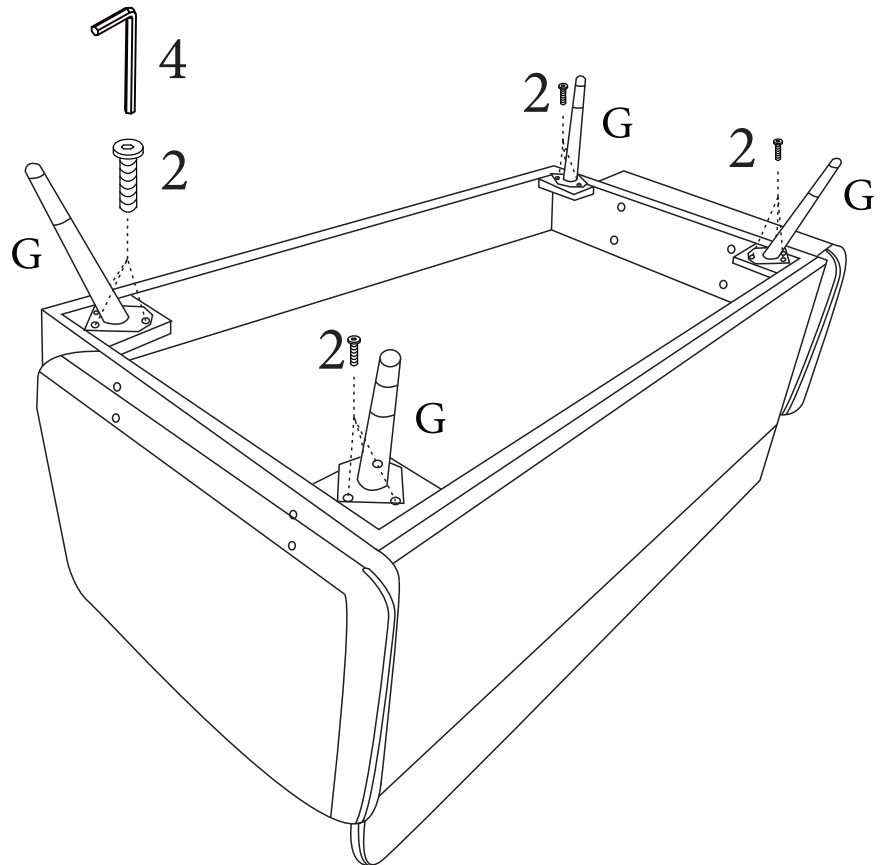

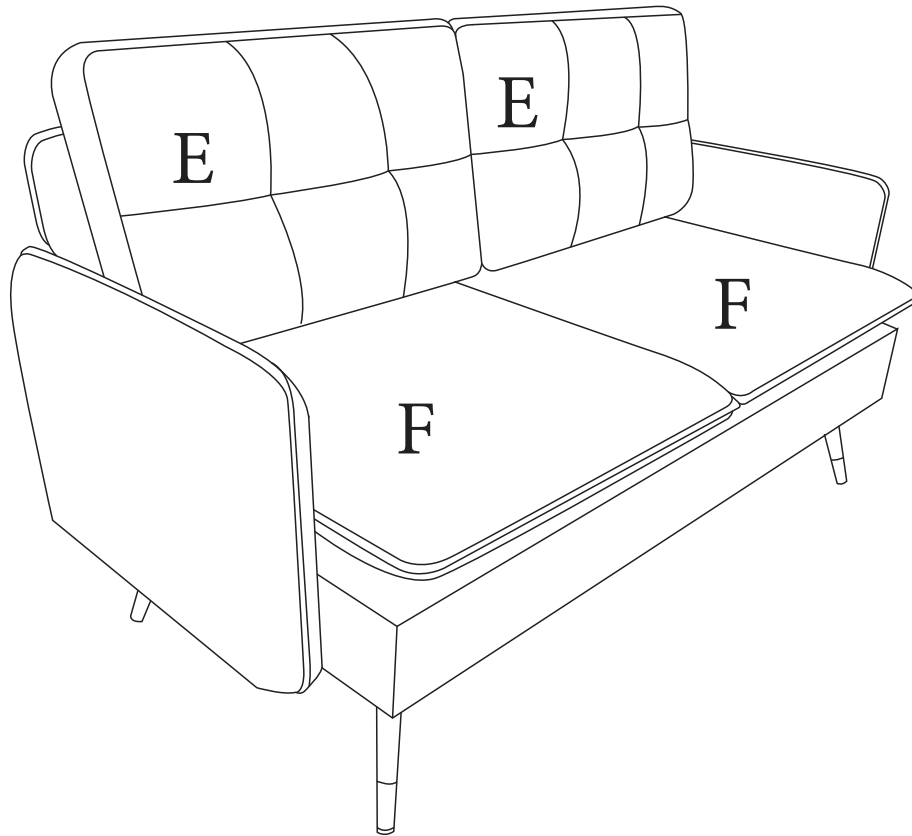
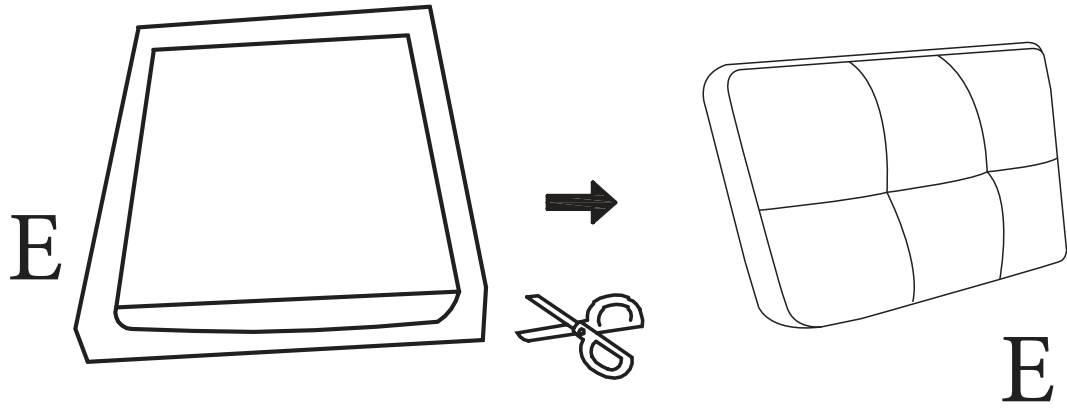

If you have any questions, please contact our customer care center, Our contact details are below:

**US**

 001-877-644-9366

 customerservice@aosom.com

Imported by Aosom LLC  
27150 SW Kinsman Rd Wilsonville, OR 97070 USA  
MADE IN CHINA

If you have any questions, please contact our customer care center, Our contact details are below:

**UK**

 0044-800-240-4004

 enquiries@mhstar.co.uk

IMPORTER ADDRESS:  
MH STAR UK LTD  
Unit 27, Perivale Park,  
Horsenden lane South  
Perivale, UB6 7RH  
MADE IN CHINA

If you have any questions, please contact our customer care center, Our contact details are below:

**CA**

Si vous avez la moindre question, veuillez contacter notre centre d'assistance à la clientèle, Nos coordonnées sont les suivantes:

 416-792-6088

 customerservice@aosom.ca

Imported by Aosom Canada Inc.  
7270 Woodbine Avenue, Unit 307, Markham,  
Ontario Canada L3R 4B9  
MADE IN CHINA

Importé par Aosom Canada Inc.  
7270 Woodbine Avenue, unité 307, Markham,  
Ontario Canada L3R 4B9  
FABRIQUÉ EN CHINE

Wenn Sie Fragen haben, wenden Sie sich bitte an unser Kundendienstzentrum, Unsere Kontaktdaten stehen unten:

**DE**

 0049-0(40)-88307530

 service@aosom.de

ADRESSE DES IMPORTEUR/Hersteller/REP:  
MH Handel GmbH Wendenstraße 309 D-20537  
Hamburg  
Germany  
IN CHINA HERGESTELLT

In caso di dubbio, si prega di contattare il nostro centro assistenza clienti, I nostri dettagli di contatto sono di seguito:

**IT**

 0039-0249471447

 clienti@aosom.it

IMPORTATO DA/Produttore/REP: AOSOM Italy srl  
Centro Direzionale Milanofiori Strada 1 Palazzo F1  
20057 Assago (MI)  
P.I.: 08567220960  
FATTO IN CINA

Si tiene alguna pregunta, comuníquese con nuestro Centro de Atención al Cliente, Nuestros datos de contacto son los siguientes:

**ES**

 0034-931294512

 atencioncliente@aosom.es

IMPORTADOR/Fabricante/REP:  
SPANISH AOSOM, S.L.  
C/ROC GROS, Nº15.08550, ELS HOSTALET DE  
BALENYÀ, SPAIN.  
B66295775  
HECHO EN CHINA

Se tiver alguma dúvida, por favor contacte o nosso Centro de Atendimento ao Cliente, Os nossos dados de contacto são os seguintes:

**PT**

 0034-931294512

 info@aosom.pt.

IMPORTADOR/Fabricante/REP: SPANISH  
AOSOM, S.L C.ROC GROS N.15, 08550. ELS  
HOSTALET DE BALENYÀ  
FEITO NA CHINA

Si vous avez la moindre question, veuillez contacter notre centre d'assistance à la clientèle, Nos coordonnées sont les suivantes:

**FR**

 0033-1-84166106  aosom@mhfrance.fr

Importé par/Fabricant/REP: MH FRANCE 2 Rue Maurice Hartmann 92130 Issy Les Moulineaux  
France  
FABRIQUÉ EN CHINE



**FR**

**DONNEZ  
OU  
RECYCLEZ**



OU



OU



ASSOCIATION

LIVRAISON

DÉCHÈTERIE

Adresses sur [quefairedemesdechets.fr](http://quefairedemesdechets.fr)