

PawHut

IN241100146V01_GL

D51-436V01

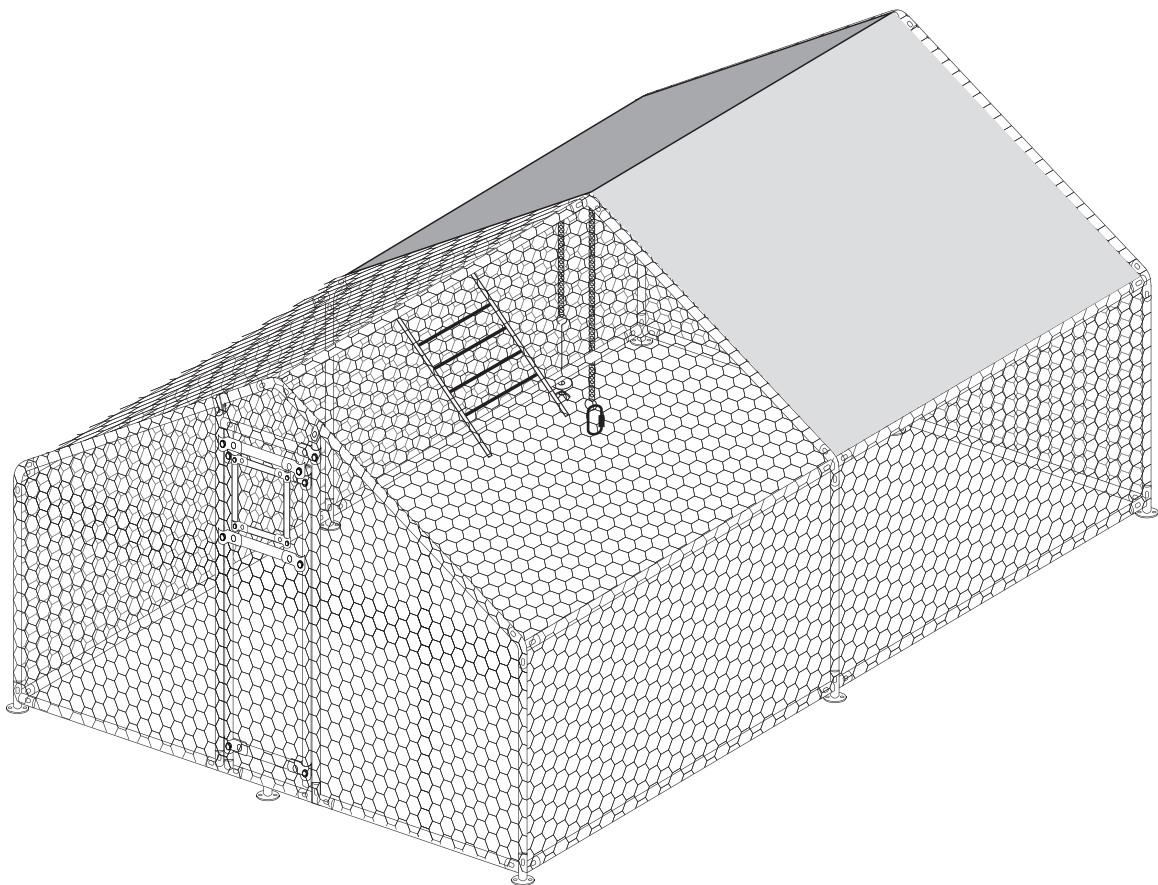

13

STEPS



2 HR



EN_IMPORTANT, RETAIN FOR FUTURE REFERENCE: READ CAREFULLY.











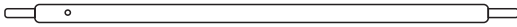

FR_IMPORTANT: A LIRE ATTENTIVEMENT ET À CONSERVER POUR CONSULTATION ULTÉRIEURE.

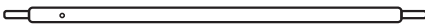
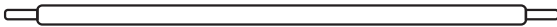
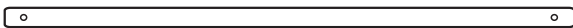
ES_IMPORTANTE, LEA Y GUARDE PARA FUTURAS REFERENCIAS.

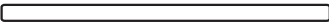
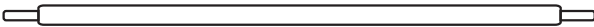
PT_IMPORTANTE, RETER PARA REFERÊNCIA FUTURA: LEIA ATENTAMENTE.

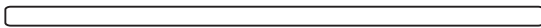
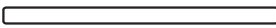
DE_WICHTIG! SORGFÄLTIG LESEN UND FÜR SPÄTER NACHSCHLAGEN AUFBEWAHREN.

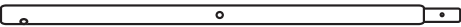
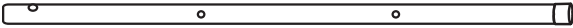
IT_IMPORTANTE! CONSERVARE IL PRESENTE MANUALE PER FUTURO RIFERIMENTO E LEGGERLO ATTENTAMENTE.

	1 x 4 1420
	2 x 6 1925
	2A x 4 1925
	3 x 2 970
	3A x 4 970
	4 x 6 1540
	5 x 1 1687
	5A x 1 1687
	6 x 1 605
	7 x 1 1850
 Φ 16 395mm	10 x 8 395
	A x 2 1600
	C x 3 497
	8 x 2 420
	11 x 2 390
	12 x 2 585
	13 x 2 870
	B x 4 900

D x 5



E1 x 2



E2 x 2

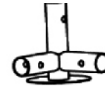

F x 3

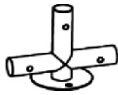

G x 1



H x 3



V x 1



I x 32



J x 4



J1 x 4



K x 36
M6
+1(spare)



L x 10
M8
+1(spare)

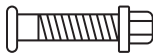

Y x 8
M6
+1(spare)



M x 2

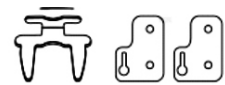

O x 1

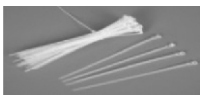

P x 1



Q x 1

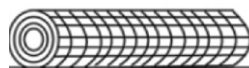

Z x 1



R x 20



S x 1



T x 2



W x 8

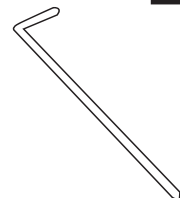

EN_ATTENTION: E1 & E2 shall be placed in strict order otherwise they cannot be installed
DIFFERENT HOLES SITUATIONS IN E1&E2

FR_ATTENTION : E1 & E2 doivent être placés dans un ordre strict, sinon ils ne peuvent pas être installés.

DIFFÉRENTES SITUATIONS DE TROUS DANS E1&E2

ES_ATENCIÓN: E1 & E2 deben colocarse en estricto orden, de lo contrario no podrán instalarse

DIFERENTES SITUACIONES DE AGUJEROS EN E1&E2

PT_ATENÇÃO: E1 e E2 devem ser colocados por ordem rigorosa, caso contrário não podem ser instalados

DIFERENTES SITUAÇÕES DE FUROS EM E1 E E2

DE_ACHTUNG: E1 und E2 müssen in strenger Reihenfolge angebracht werden, da sie sonst nicht installiert werden können.



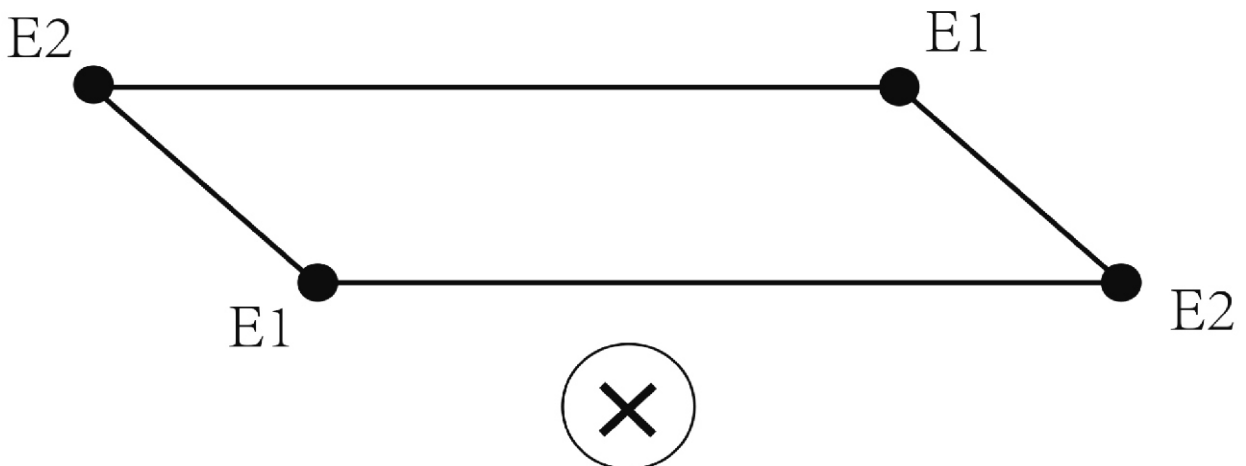
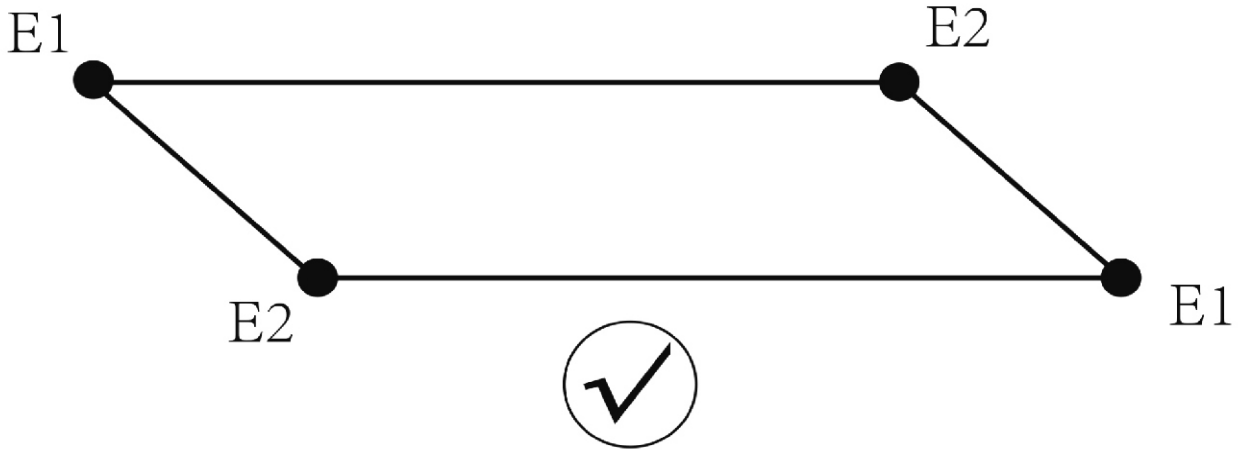
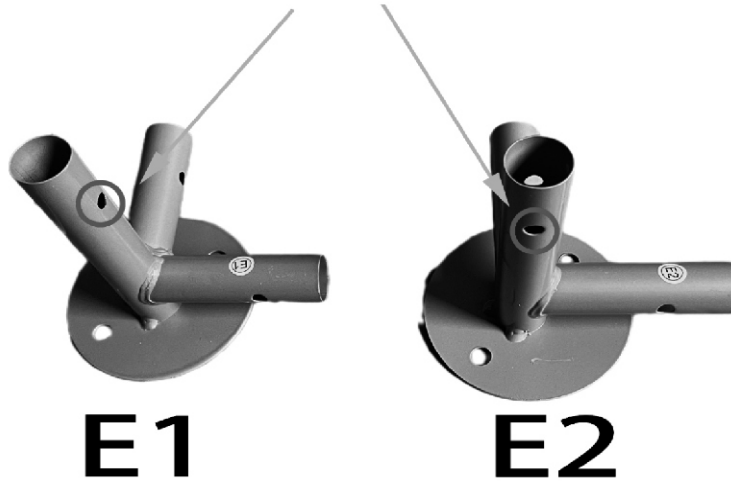

VERSCHIEDENE LOCHSITUATIONEN IN E1&E2

IT_ATTENZIONE: E1 ed E2 devono essere posizionati in ordine rigoroso, altrimenti non possono essere installati.

SITUAZIONI DI FORI DIVERSI IN E1&E2



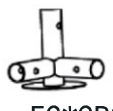

STEP1

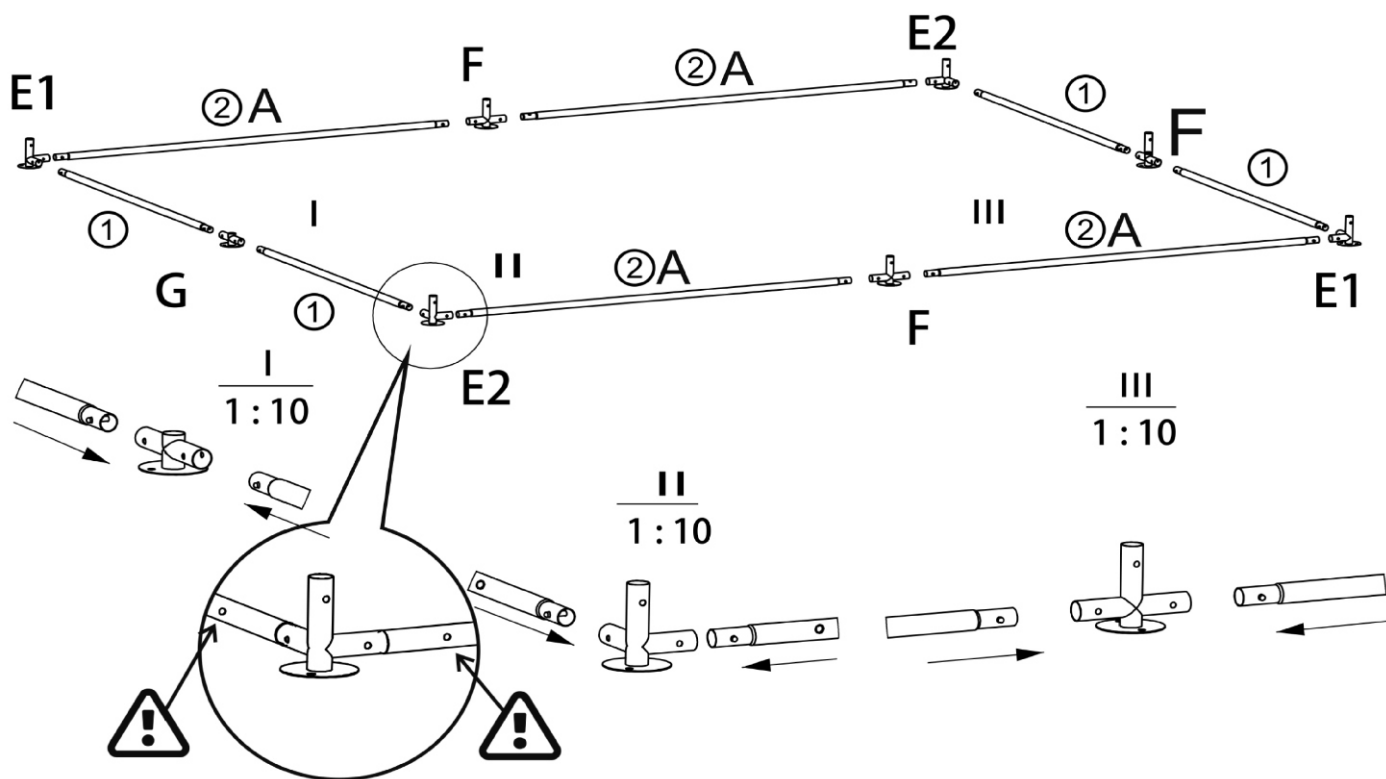
Required Tools	 ①*4PCS	 ②A*4PCS	 E1*2PCS
 E2*2PCS	 G*1PCS	 F*3PCS	





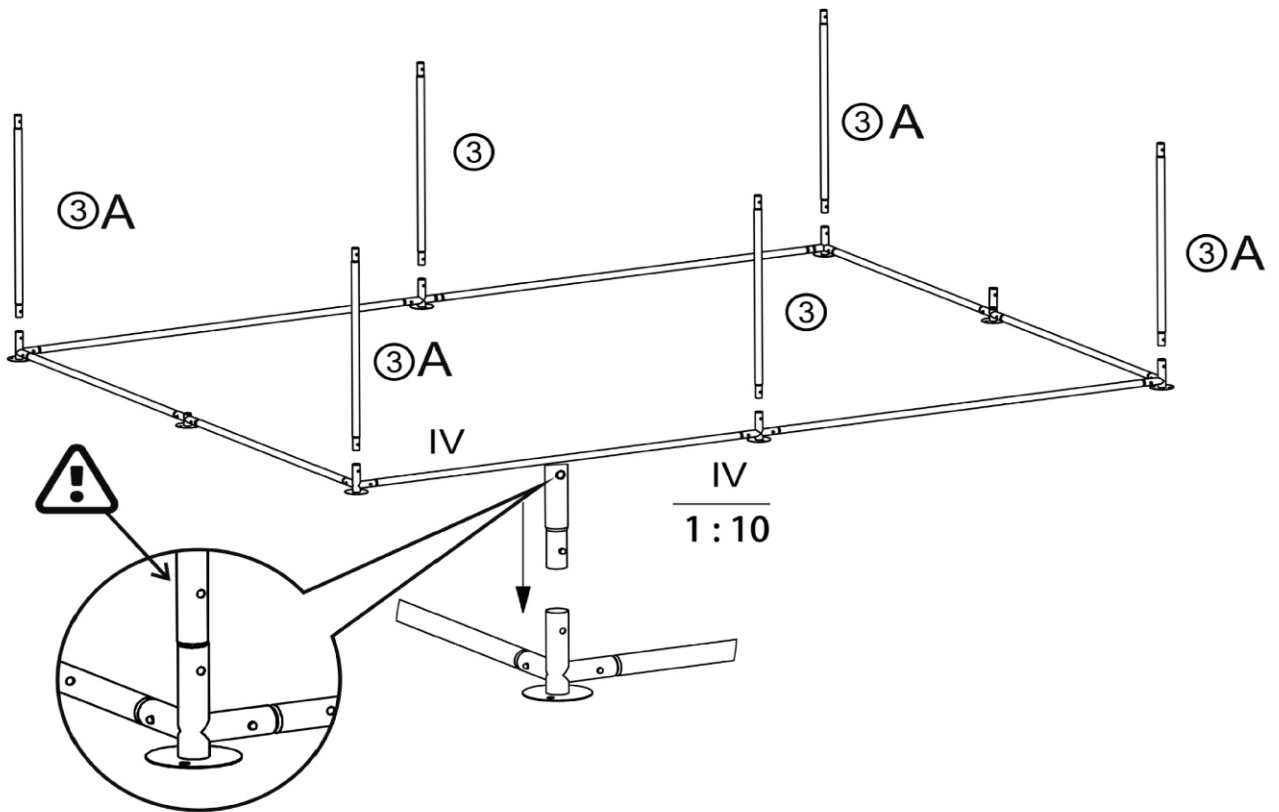

STEP2

Required Tools	 ③A*4PCS	 ③*2PCS
----------------	--	---

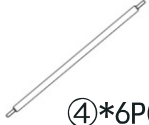



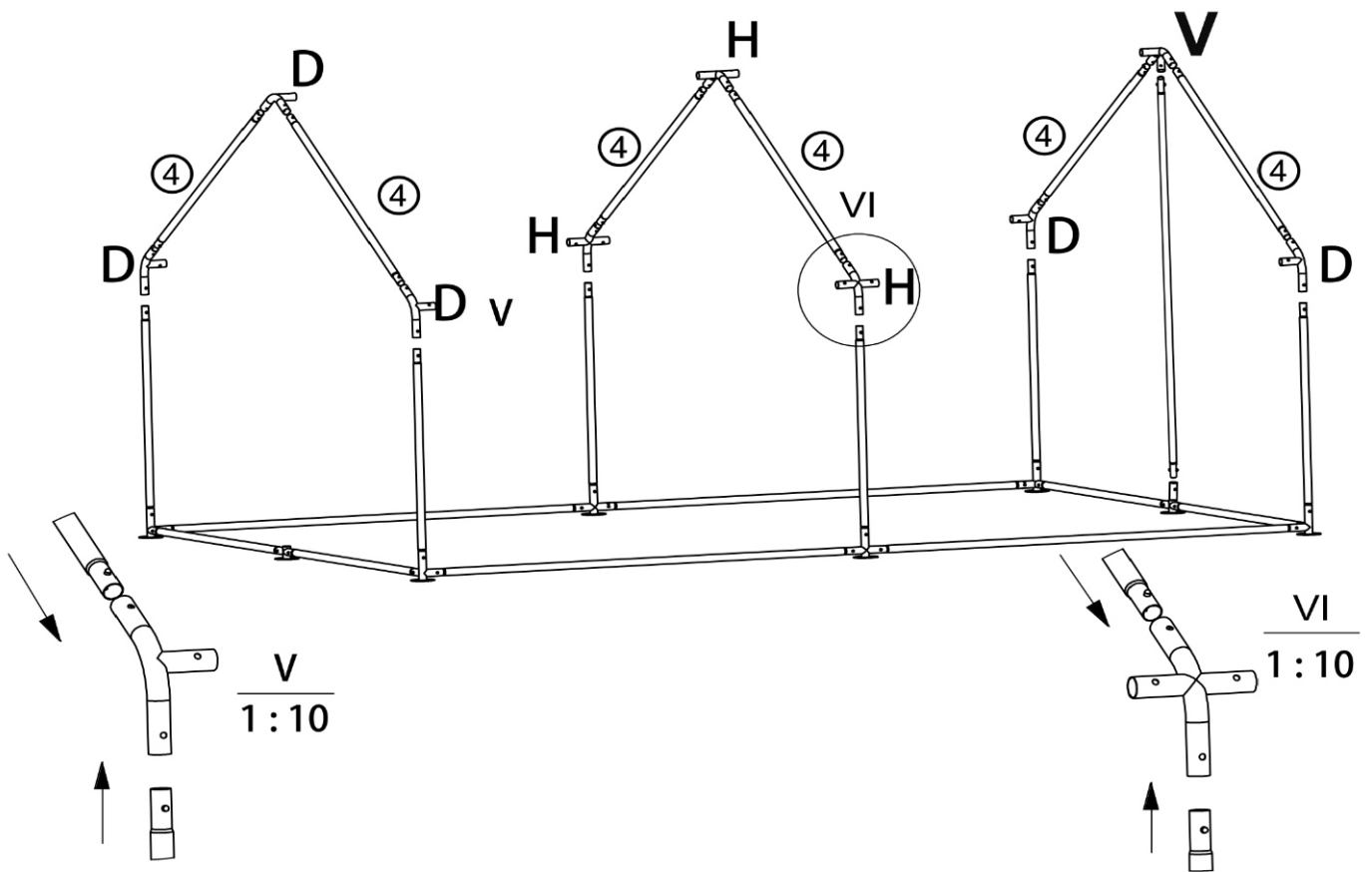

STEP3

<p>Required Tools</p>	 <p>④*6PCS</p>	 <p>D*5PCS</p>	 <p>H*3PCS</p>	 <p>V*1PCS</p>
-----------------------	---	---	---	--

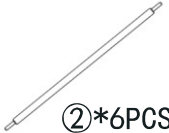

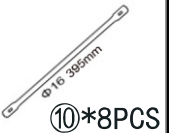



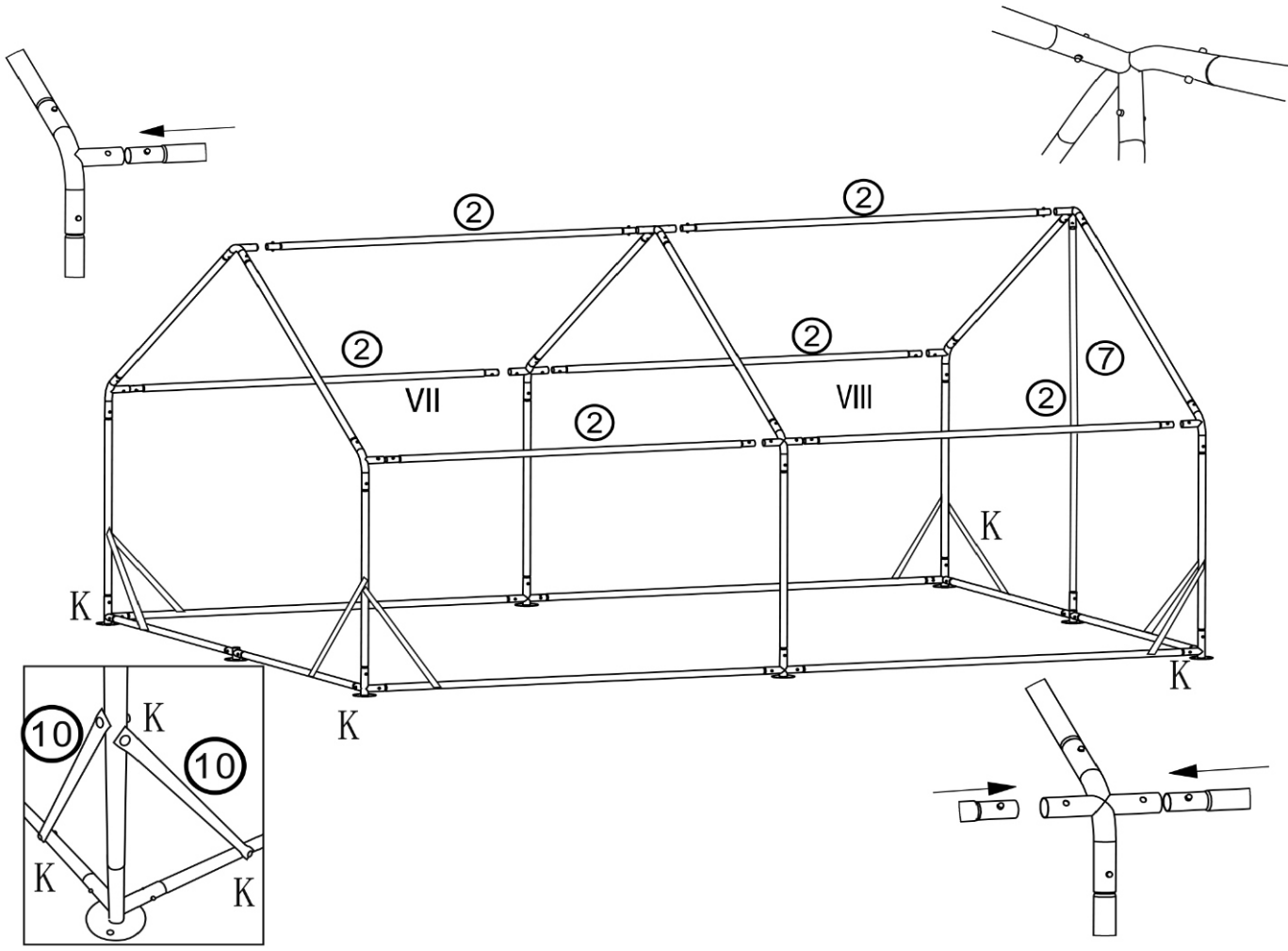

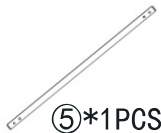

STEP4

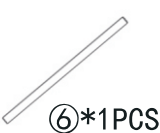
<p>Required Tools</p>	 <p>②*6PCS</p>	 <p>⑦*1PCS</p>	 <p>⑩*8PCS</p>	 <p>K*16PCS</p>
-----------------------	---	---	---	--





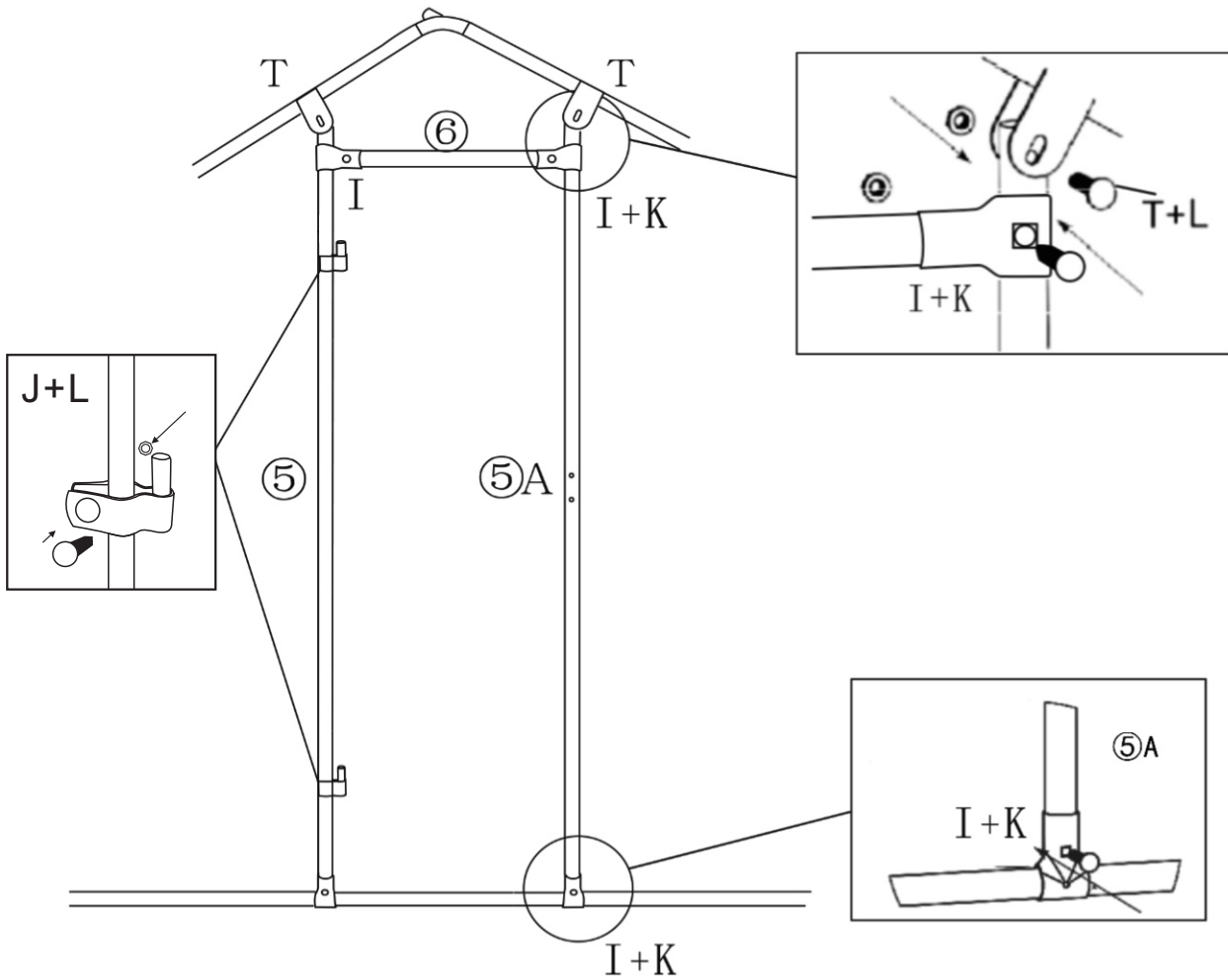

STEP5

Required Tools	 ⑤*1PCS	 ⑤A*1PCS	 ⑥*1PCS	 T*2PCS
 J*2PCS	 I*8PCS	 L*4PCS	 K*4PCS	

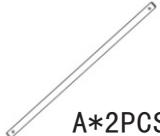
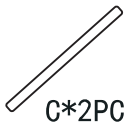

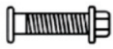

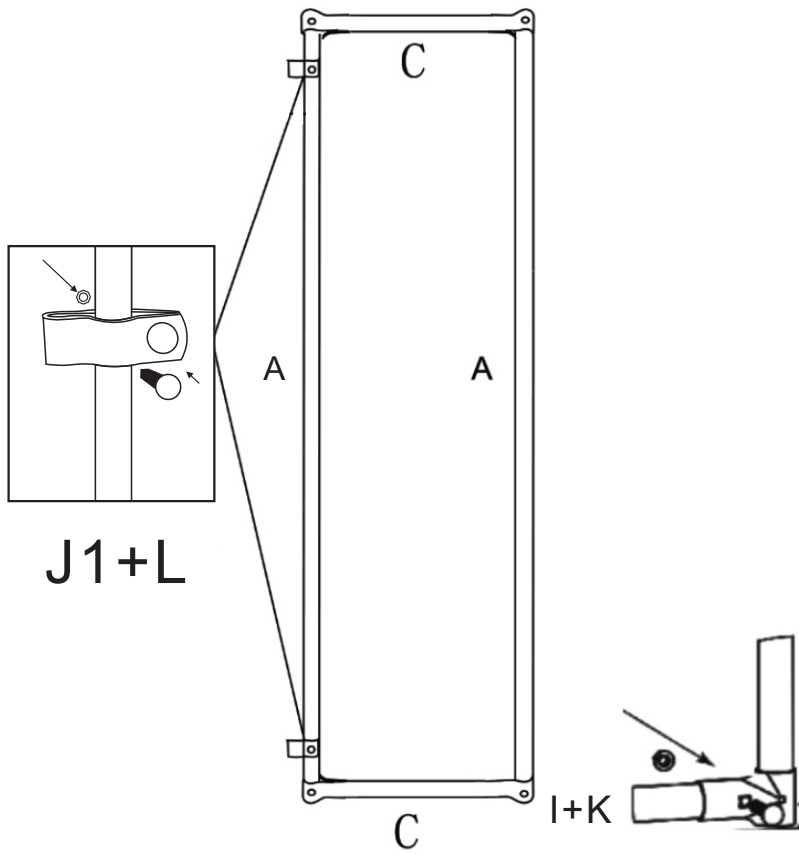

STEP 6

Required Tools	 A*2PCS	 C*2PCS		
 J1*2PCS	 K*4PCS	 L*2PCS	 I*8PCS	





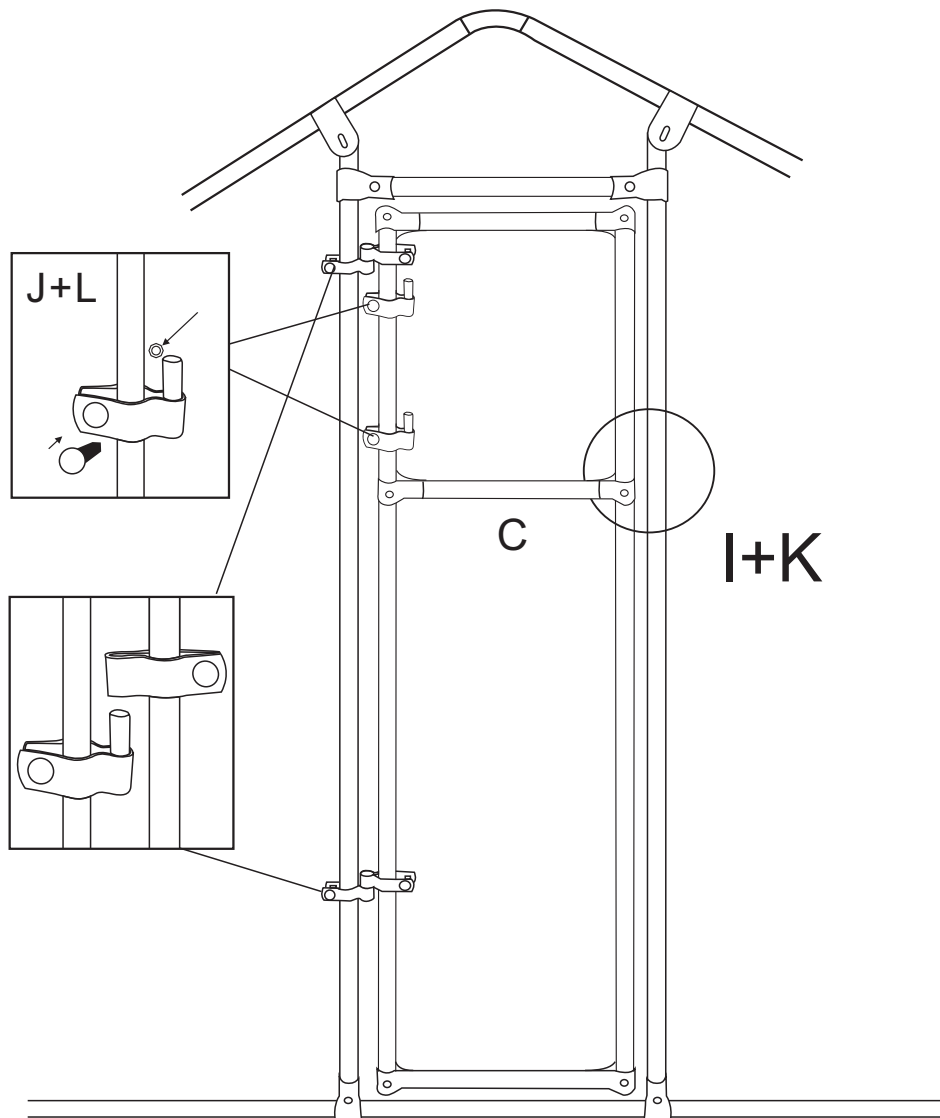

STEP 7

Required Tools			
	C*1PCS	I*4PCS	K*2PCS
			
	J*2PCS	L*2PCS	

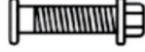

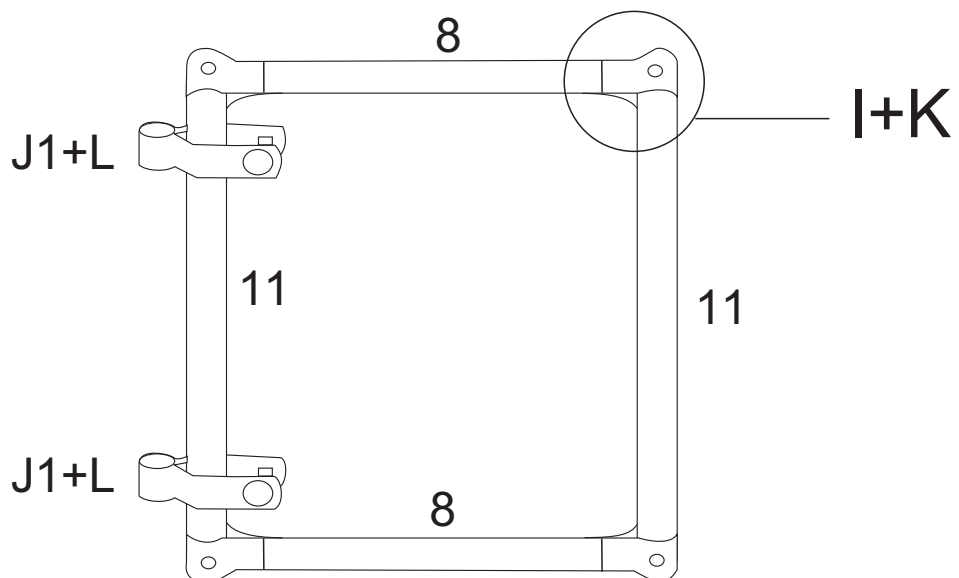

STEP8

Required Tools	 I*8PCS	 K*4PCS	 L*2PCS	 J1*2PCS
 ⑧*2PCS	 ⑪*2PCS			



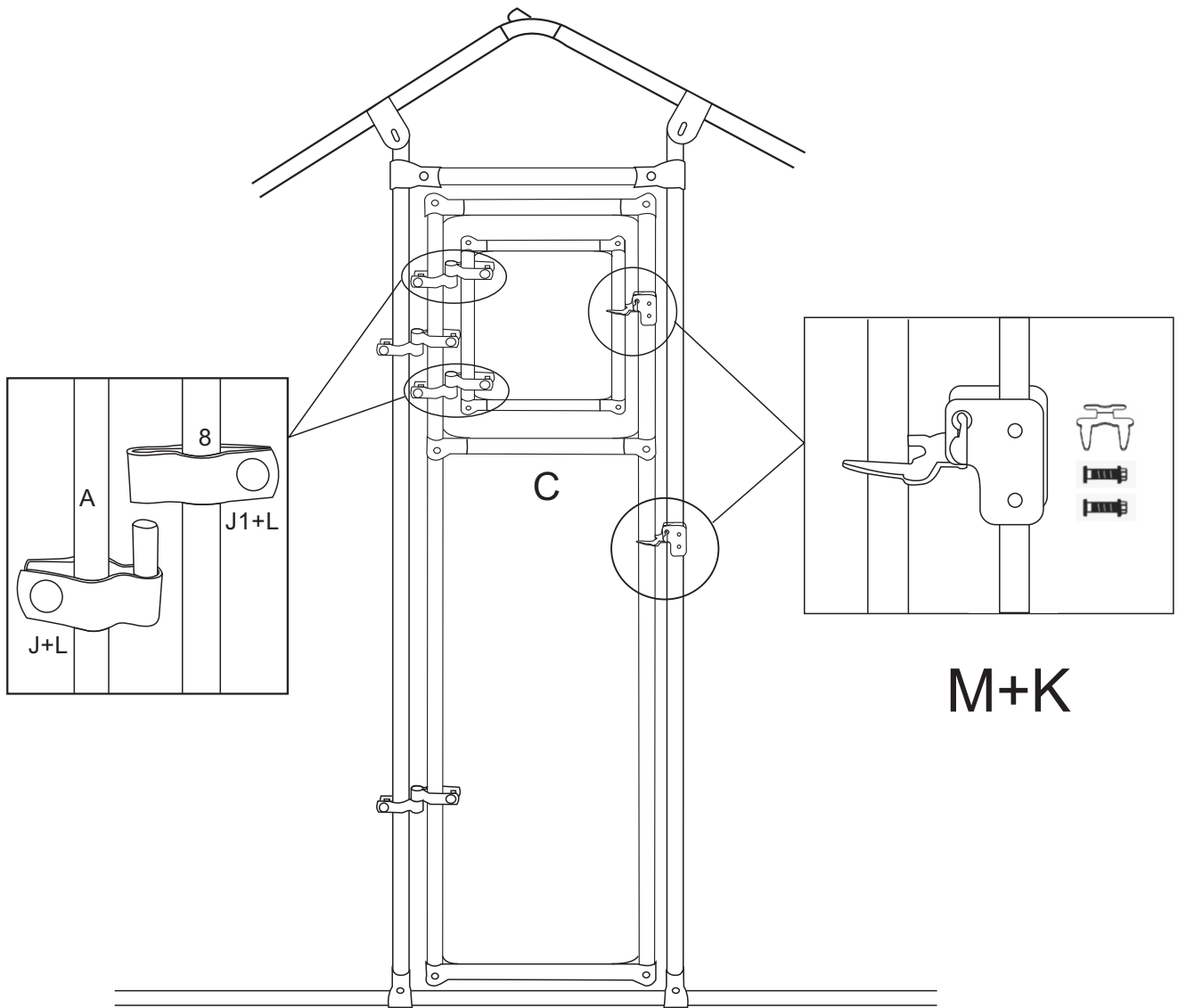

STEP9

Required Tools	 M*2PCS	 K*4PCS
-------------------	---	---

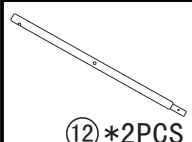
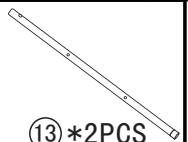
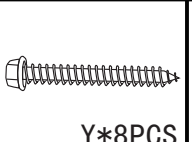

STEP10

Required Tools	 ⑫ *2PCS	 ⑬ *2PCS	 Y*8PCS	 B*4PCS
----------------	---	---	--	--

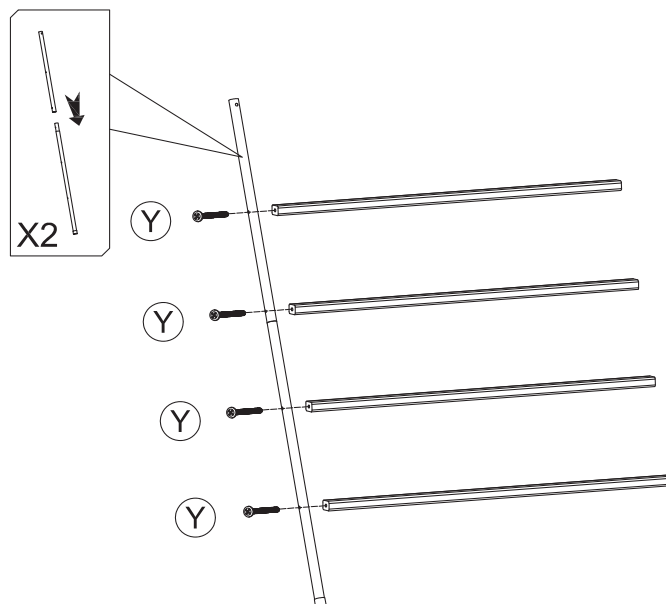

EN_1. Connect the upper and lower iron pipes on the left side, then assemble the crossbar

FR_1. connecter les tuyaux en fer supérieurs et inférieurs sur le côté gauche, puis assembler la barre transversale

ES_1. Conecte los tubos de hierro superior e inferior del lado izquierdo y, a continuación, monte el travesaño

PT_1. ligar os tubos de ferro superior e inferior do lado esquerdo, depois montar a barra transversal

DE_1. die oberen und unteren Eisenrohre auf der linken Seite verbinden, dann die Querstange montieren

IT_1. Collegare i tubi di ferro superiori e inferiori sul lato sinistro, quindi assemblare la traversa.

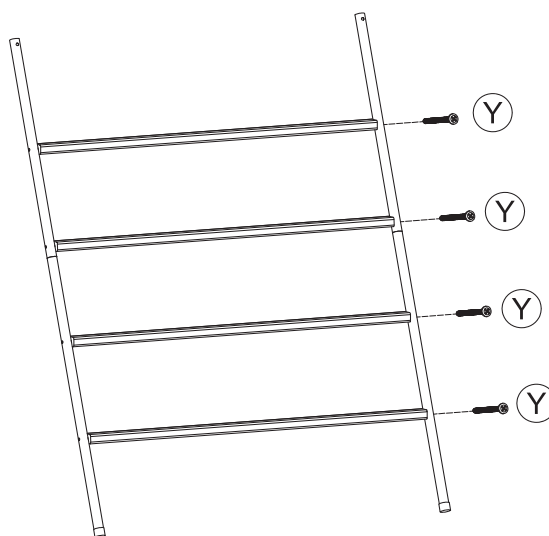

EN_2. Assemble the upper and lower iron pipes on the right side to form a chicken perch

FR_2) Assembler les tuyaux en fer supérieurs et inférieurs sur le côté droit pour former un perchoir à poulets.

ES_2. Ensambla los tubos de hierro superior e inferior del lado derecho para formar un gallinero

PT_2. montar os tubos de ferro superior e inferior do lado direito para formar um poleiro de galinha

DE_2. die oberen und unteren Eisenrohre auf der rechten Seite zu einer Hühnerstange zusammensetzen



IT_2. Assemblare i tubi di ferro superiori e inferiori sul lato destro per formare un trespolo per polli.

STEP11

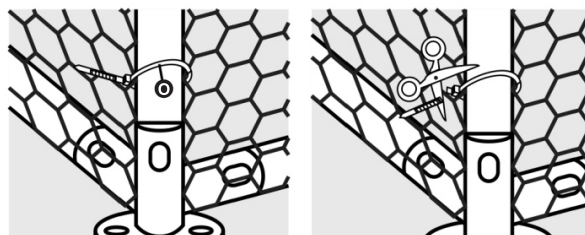
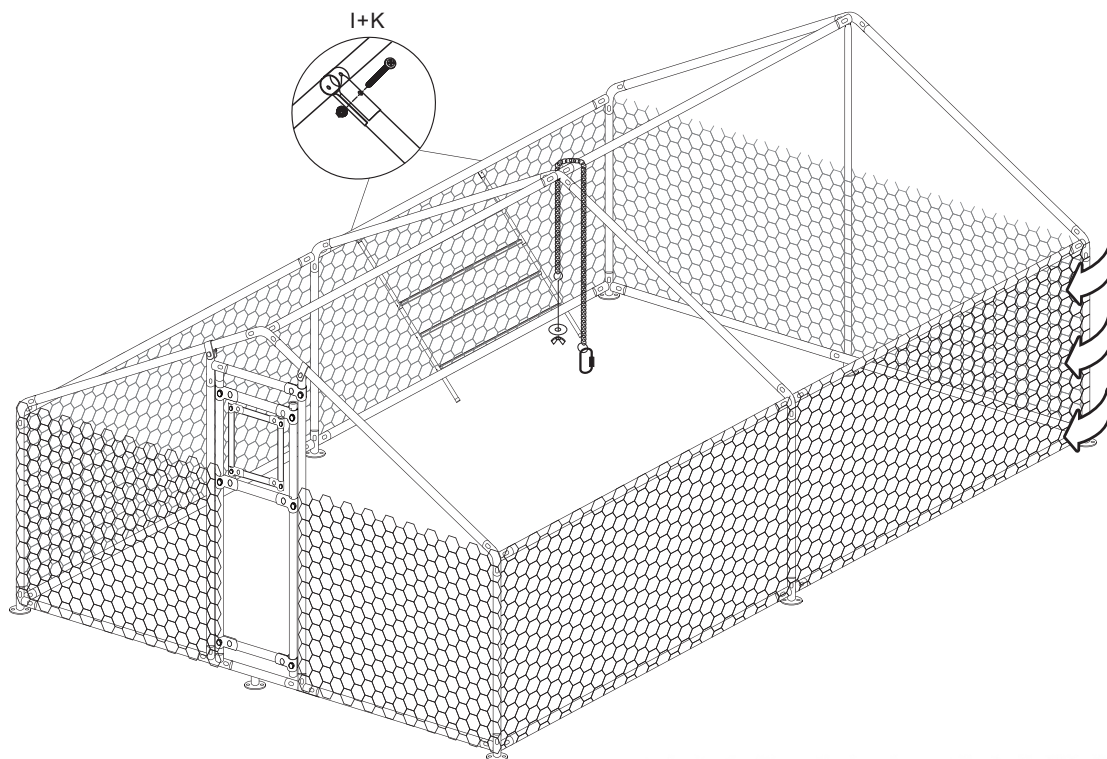
Required Tools	 Q*1PCS	 O*1SET	 Z*1PCS	 I*4PCS	 K*2PCS
-------------------	---	---	---	---	---



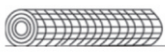

STEP12

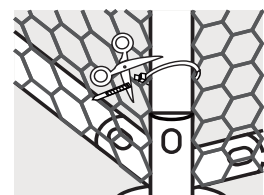
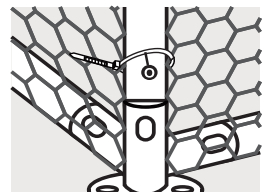
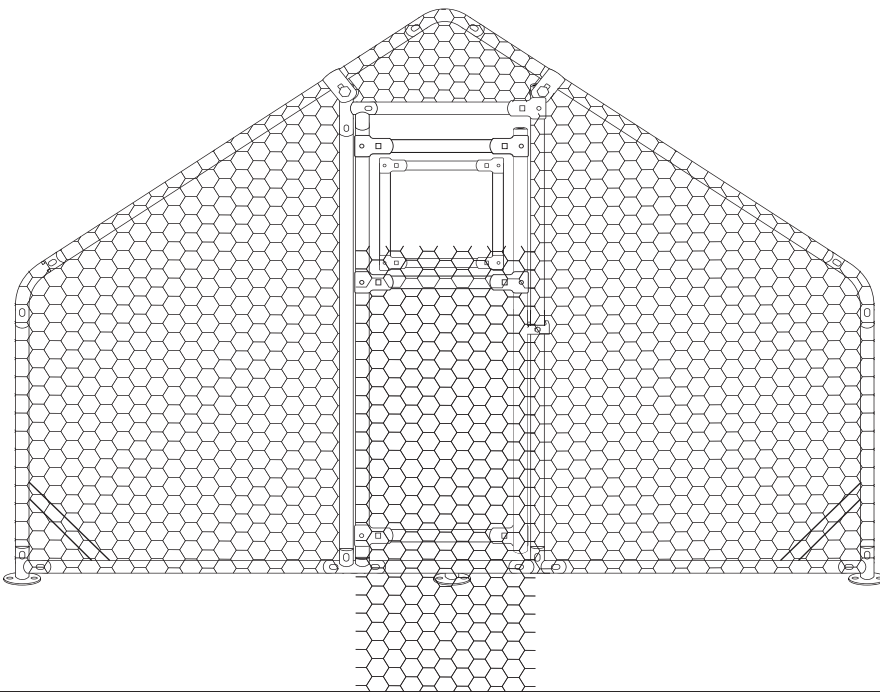
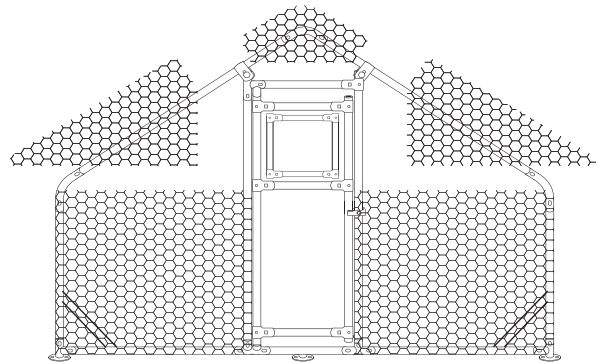
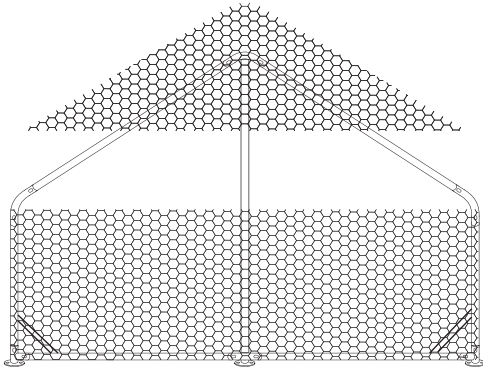
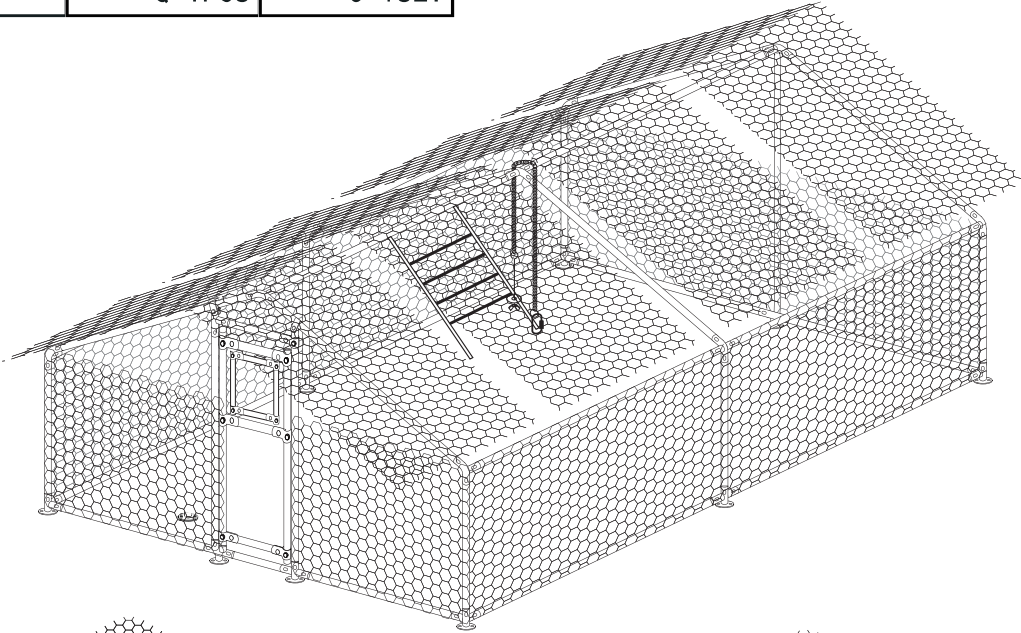
Required Tools	 Q*1PCS	 0*1SET
-------------------	---	---



STEP13

Required Tools	 P*1PCS	 R*20PCS	 W*8PCS
----------------	---	--	---

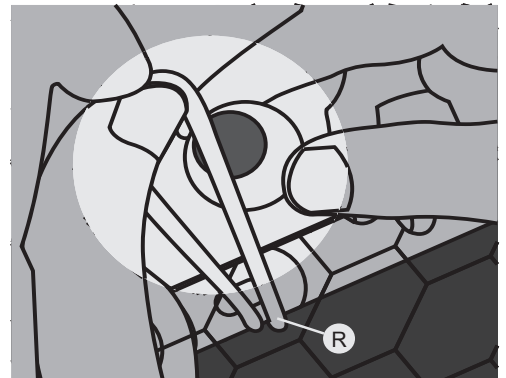
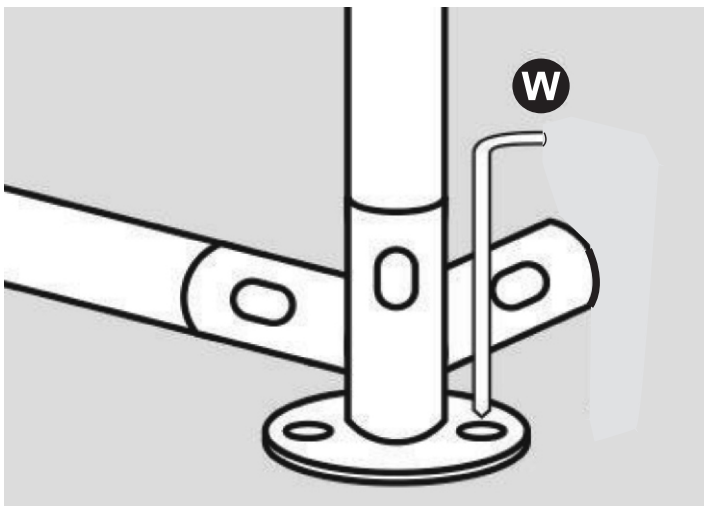
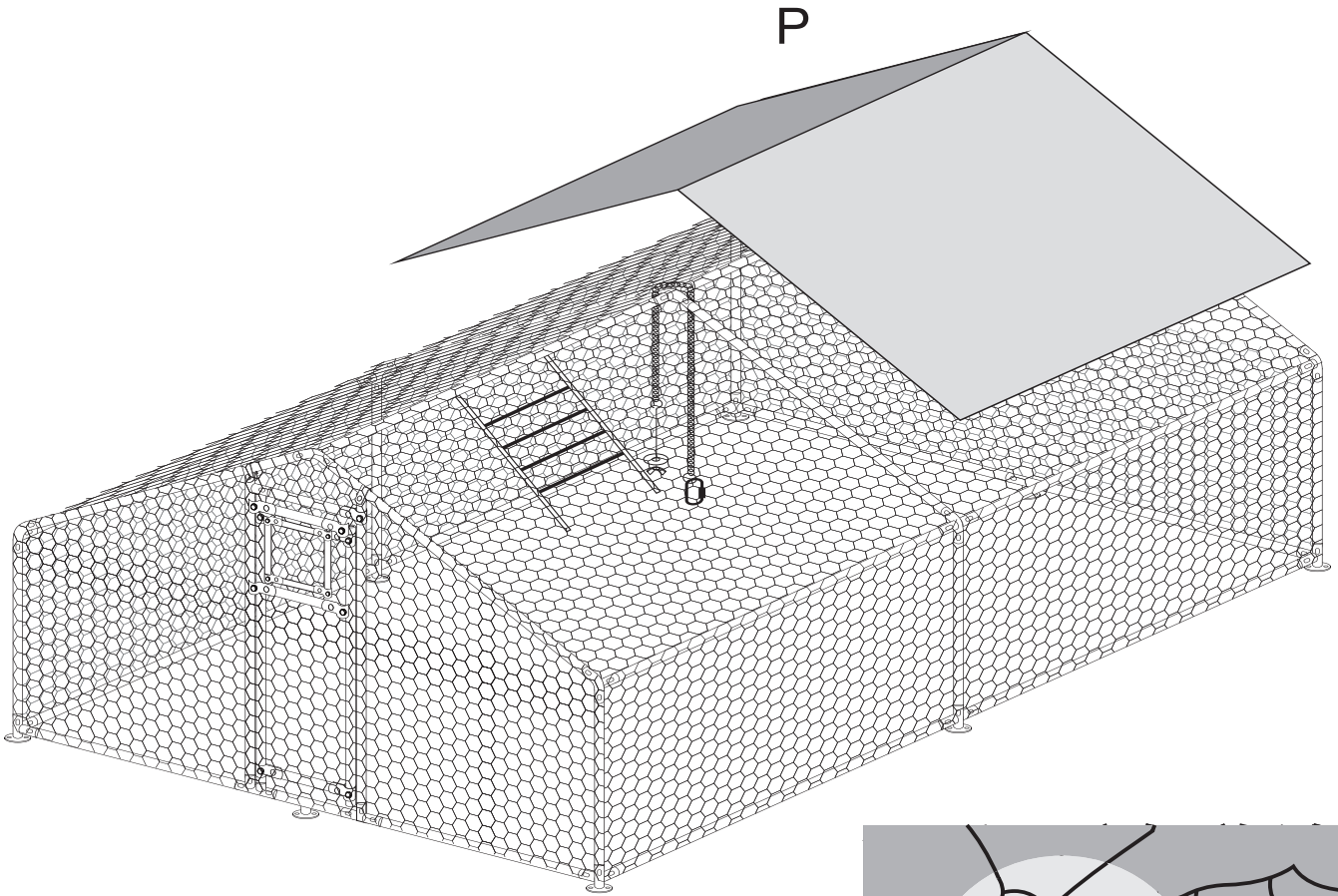

If you have any questions, please contact our customer care center, Our contact details are below:

US

 001-877-644-9366

 customerservice@aosom.com

Imported by Aosom LLC
27150 SW Kinsman Rd Wilsonville, OR 97070 USA
MADE IN CHINA

If you have any questions, please contact our customer care center, Our contact details are below:

CA

 416-792-6088

 customerservice@aosom.ca

Imported by Aosom Canada Inc.
7270 Woodbine Avenue, Unit 307, Markham,
Ontario Canada L3R 4B9
MADE IN CHINA

Si vous avez la moindre question, veuillez contacter notre centre d'assistance à la clientèle, Nos coordonnées sont les suivantes:

 416-792-6088

 customerservice@aosom.ca

Importé par Aosom Canada Inc.
7270 Woodbine Avenue, unité 307,
Markham, Ontario Canada L3R 4B9
FABRIQUÉ EN CHINE

If you have any questions, please contact our customer care center, Our contact details are below:

UK

 0044-800-240-4004

 enquiries@mhstar.co.uk

IMPORTER ADDRESS:
MH STAR UK LTD
Unit 27, Perivale Park,
Horsenden lane South
Perivale, UB6 7RH
MADE IN CHINA

Si vous avez la moindre question, veuillez contacter notre centre d'assistance à la clientèle, Nos coordonnées sont les suivantes:

FR

 0033-1-84166106

 aosom@mhfrance.fr

Importé par/Fabricant/REP:
MH FRANCE
2 Rue Maurice Hartmann
92130 Issy Les Moulineaux
France
FABRIQUÉ EN CHINE

Wenn Sie Fragen haben, wenden Sie sich bitte an unser Kundendienstzentrum, Unsere Kontaktdaten stehen unten:

DE

 0049-0(40)-88307530

 service@aosom.de

ADRESSE DES IMPORTEURE/Hersteller/REP:
MH Handel GmbH
Wendenstraße 309
D-20537 Hamburg
Germany
IN CHINA HERGESTELLT

In caso di dubbio, si prega di contattare il nostro centro assistenza clienti, I nostri dettagli di contatto sono di seguito:

IT

 0039-0249471447

 clienti@aosom.it

IMPORTATO DA/Produttore/REP:
AOSOM Italy srl
Centro Direzionale Milanofiori
Strada 1 Palazzo F1
20057 Assago (MI)
P.I.: 08567220960
FATTO IN CINA

Si tiene alguna pregunta, comuníquese con nuestro Centro de Atención al Cliente, Nuestros datos de contacto son los siguientes:

ES

 0034-931294512

 atencioncliente@aosom.es

IMPORTADOR/Fabricante/REP:
SPANISH AOSOM, S.L.
C/ROC GROS, N°15.08550, ELS HOSTALETS DE
BALENYÀ, SPAIN.
B66295775
HECHO EN CHINA

Se tiver alguma dúvida, por favor contacte o nosso Centro de Atendimento ao Cliente, Os nossos dados de contacto são os seguintes:

PT

 0034-931294512

 info@aosom.pt.

IMPORTADOR/Fabricante/REP:
SPANISH AOSOM, S.L.
C.ROC GROS N.15, 08550. ELS HOSTALETS DE
BALENYÀ
FEITO NA CHINA



FR

**DONNEZ
OU
RECYCLEZ**



ASSOCIATION

OU



LIVRAISON

OU



DÉCHÈTERIE

Adresses sur quefairedemesdechets.fr