



EN_IMPORTANT, RETAIN FOR FUTURE REFERENCE: READ CAREFULLY.

FR_IMPORTANT: A LIRE ATTENTIVEMENT ET À CONSERVER POUR CONSULTATION ULTÉRIEURE.

ES_IMPORTANTE, LEA Y GUARDE PARA FUTURAS REFERENCIAS.

DE_WICHTIG! SORGFÄLTIG LESEN UND FÜR SPÄTER NACHSCHLAGEN AUFBEWAHREN.

IT_IMPORTANTE! CONSERVARE IL PRESENTE MANUALE PER FUTURO RIFERIMENTO E LEGGERLO ATTENTAMENTE.

EN

1.Using Instruction

- The desk board can be adjusted between 0-45 (up and down),and tighten it by screwing the two rotation buttons on the both sides.

2.Maintenance

- Traces left by water-based pens such as pencils, pens, and water color pens can be wiped with water.
- Traces left by oily pen can be wiped by alcohol and balm.
- The desk board is moisture proof and scratch-resistant, But please do not use any blade to scratch It.

3.Notices

- This product is suitable for kids aged from 6 to 12.
- Maximum Weight Capacity of Chair: 100 Kg; Maximum Weight Capacity of Table: 80 Kg.
- This product can only be assembled by adults.
- Please be extra careful and operate correctly when adjusting the height and the desk board.
- This product contains a light source of energy efficiency class <G>.
- DO NOT place this product near a window as it can be used as a step by the child and cause the child to fall out of the window.
- Be aware of the risk of open fires and other sources of strong heat in the vicinity of the product.
- DO NOT place this product near a window where cords from blinds or curtains could strangle a child.

FR

1.Instructions d'utilisation

- La planche de bureau peut être réglée entre 0-45 (haut et bas), et être serrée en vissant les deux boutons de rotation sur les deux côté.

2.Maintenance

- Les traces laissées par des stylos à base d'eau tels que les crayons, les stylos et les stylos de couleur à l'eau peuvent être essuyées avec de l'eau.
- Les traces laissées par un stylo gras peuvent être essuyées par de l'alcool et du baume.
- La planche de bureau est résistant à l'humidité et aux rayures, Mais veuillez ne pas utiliser de lame pour le gratter.

3.Avis

- Ce produit convient aux enfants âgés de 6 à 12 ans.
- Poids maximum admissible de la chaise: 100 Kg; Poids maximal admissible de la table: 80 Kg
- Ce produit ne peut être assemblé que par des adultes.
- Veuillez faire très attention et opérer correctement lors du réglage de la hauteur et du plateau du bureau.
- Ce produit est doté d'une source lumineuse de classe d'efficacité énergétique <G>.

- NE PAS placer ce produit près d'une fenêtre ; il pourrait être utilisé comme marchepied par un enfant et le faire tomber par la fenêtre.
- Soyez conscient du risque de feu ouvert et d'autres sources de forte chaleur à proximité du produit.
- NE PAS placer ce produit près d'une fenêtre où les cordons des stores ou des rideaux pourraient étrangler un enfant.



DE

1. Gebrauchsanweisung

- Die Tischplatte kann zwischen 0-45 (nach oben und unten) verstellt werden, und durch Festschrauben der beiden Drehknöpfe an beiden Seiten befestigt werden.

2. Wartung

- Spuren von Stiften auf Wasserbasis, wie Bleistifte, Kugelschreiber und Aquarellstifte, können mit Wasser abgewischt werden.
- Spuren von öligen Stiften können mit Alkohol und Balsam abgewischt werden.
- Die Tischplatte ist feuchtigkeitsgeschützt und kratzfest, aber bitte verwenden Sie keine Klinge, um sie zu zerkratzen.

3. Hinweise

- Dieses Produkt ist für Kinder von 6 bis 12 Jahren geeignet.
- Capacidad máxima de peso de la silla: 100 Kg; Capacidad máxima de peso de la mesa: 80 Kg.
- Dieses Produkt kann nur von Erwachsenen zusammgebaut werden.
- Bitte seien Sie besonders vorsichtig und arbeiten Sie richtig, wenn Sie die Höhe und die Tischplatte einstellen.
- Dieses Produkt enthält eine Lichtquelle der Energieeffizienzklasse <G>.
- Stellen Sie dieses Produkt NICHT in der Nähe eines Fensters auf, da es vom Kind als Stufe verwendet werden und das Kind dadurch aus dem Fenster fallen kann.
- Seien Sie sich der Gefahr von offenem Feuer und anderen starker Wärmequellen nahe des Produkts bewusst.
- Stellen Sie dieses Produkt NICHT in der Nähe eines Fensters auf, wo die Schnüre von Jalousien oder Vorhängen ein Kind erdrosseln könnten.

1. Instrucciones sobre uso

- El tablero de escritorio se puede ajustar entre 0-45 (arriba y abajo) grados y apriete a los dos botones de rotación en los ambos lados.

2. Mantenimiento

- Los rastros dejados por los bolígrafos a base de agua, por ejemplo, lápices, plumas y plumas de acuarela se pueden limpiar con agua.
- Los rastros dejados por los bolígrafos a base de aceite se pueden limpiar con alcohol y bálsamo.
- El tablero de escritorio es a prueba de humedad y resistente a los arañazos, sin embargo, no utilice ninguna hoja de cuchilla para rayarlo.

3. Avisos

- Este producto es pto para los niños de 6 a 12 años.
- Maximale Gewichtskapazität des Stuhls: 100 Kg; Maximale Gewichtskapazität des Tisches: 80 Kg
- Solo los adultos pueden montar este producto.
- Tenga mucho cuidado y opérelo de manera correcta al ajustar la altura y el tablero de escritorio.
- Este producto contiene una fuente de luz de clase de eficiencia de energía <G>.
- NON posizionare il prodotto vicino a una finestra, poiché potrebbe essere utilizzato come gradino dal bambino e causarne la caduta dalla finestra.
- Stare attento al rischio di fuochi e di altre fonti di forte calore nelle vicinanze del prodotto.
- NON posizionare il prodotto vicino a una finestra dove le corde delle tende o delle tapparelle potrebbero strangolare il bambino.

1. Istruzioni per Uso

- La scrivania può essere regolata tra 0-45 (su e giù) e serrarla con due manopole di rotazione su entrambi i lati.

2. Manutenzione

- Le tracce lasciate da penne a base d'acqua come matite, penne e pennarelli ad acqua possono essere pulite con acqua.
- Le tracce lasciate dalla penna oleosa possono essere eliminate con alcool e balsamo.
- La scrivania è resistente all'umidità e ai graffi, ma si prega di non utilizzare alcuna lama per graffiarla.

3. Avvisi

- Questo prodotto è adatto a bambini di età tra 6 e 12 anni.
- Capacità massima della sedia: 100 Kg; Capacità massima del tavolo: 80 Kg.
- Questo prodotto può essere assemblato solo da adulti.
- Si prega di prestare la massima attenzione e di operare correttamente durante la regolazione dell'altezza e del piano della scrivania.
- Questo prodotto contiene una sorgente luminosa con classificazione di efficienza energetica <G>.
- NON posizionare il prodotto vicino a una finestra, poiché potrebbe essere utilizzato come gradino dal bambino e causarne la caduta dalla finestra.
- Stare attento al rischio di fuochi e di altre fonti di forte calore nelle vicinanze del prodotto.
- NON posizionare il prodotto vicino a una finestra dove le corde delle tende o delle tapparelle potrebbero strangolare il bambino.

PARTS

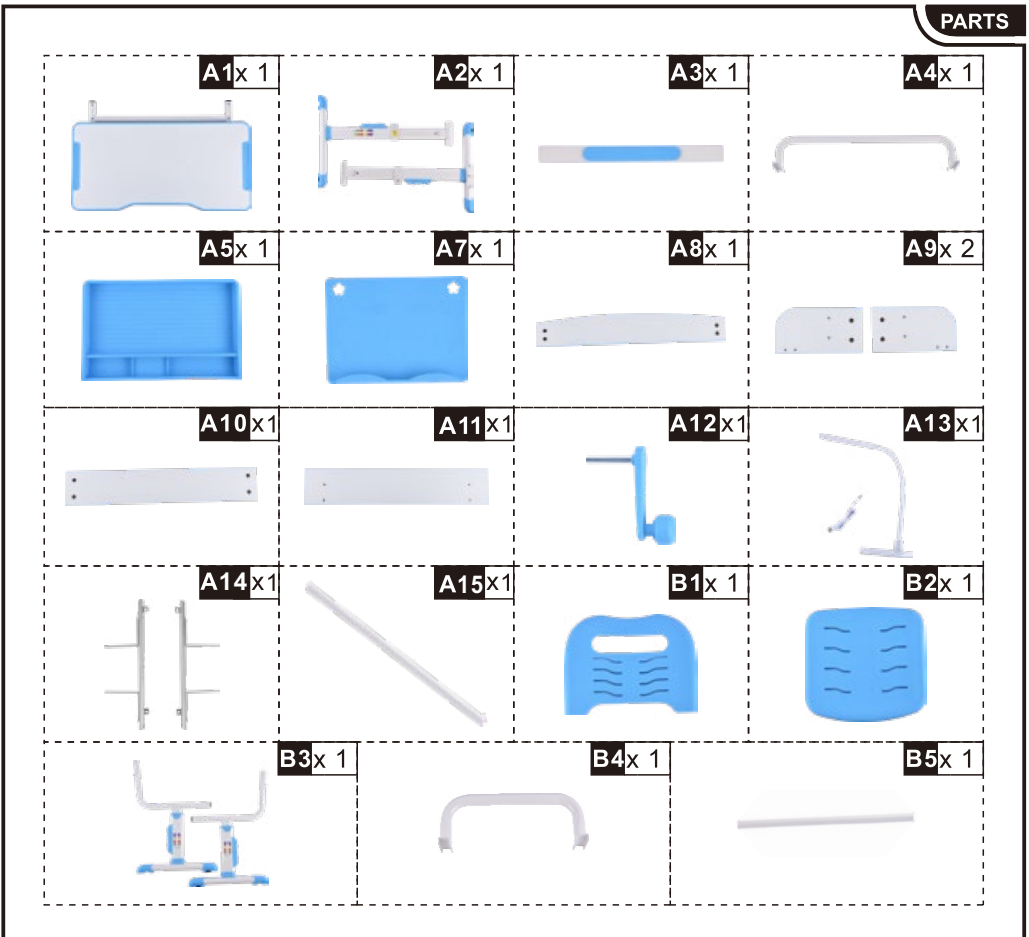

HARDWARE

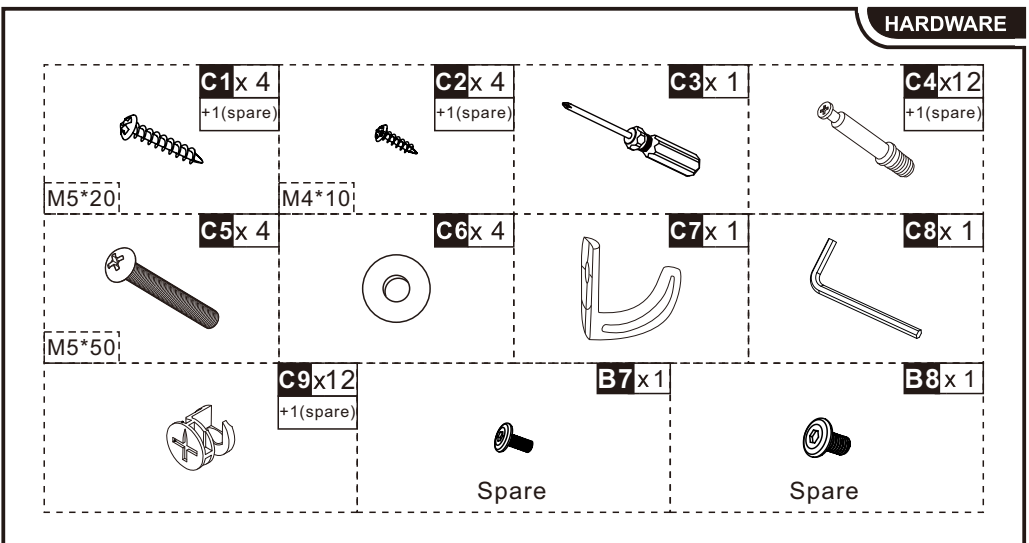

CHIARE INSTALLATION

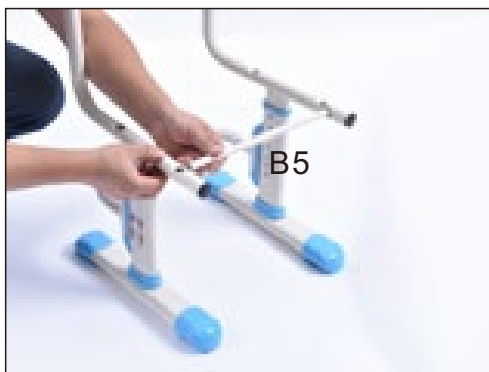
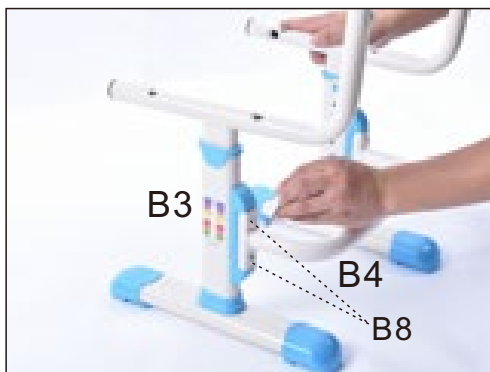
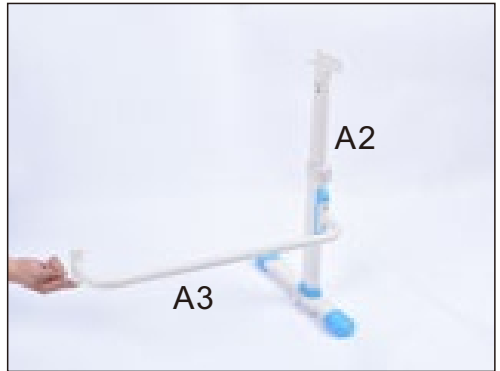
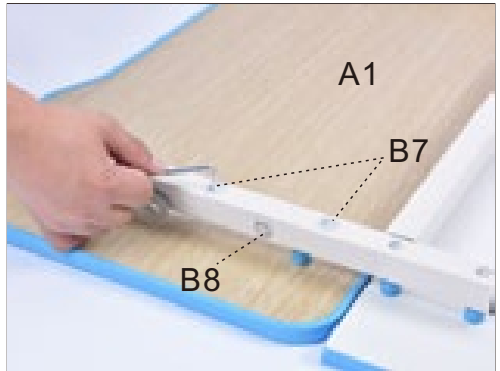
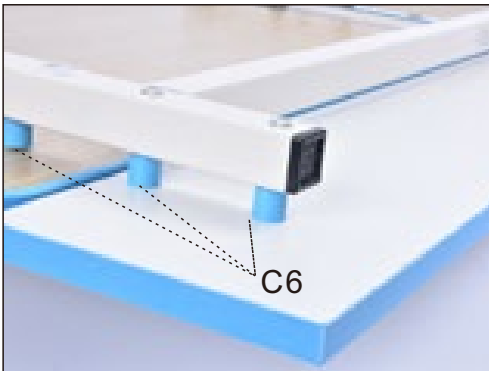
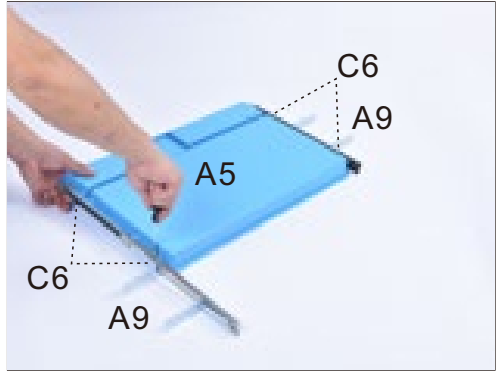
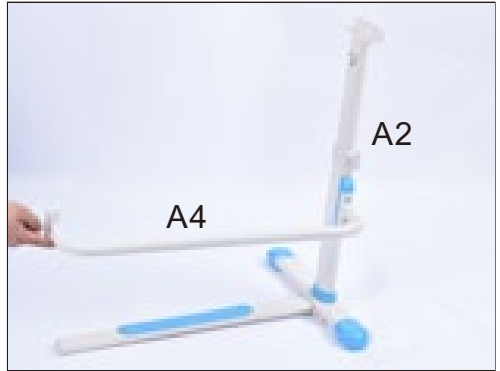
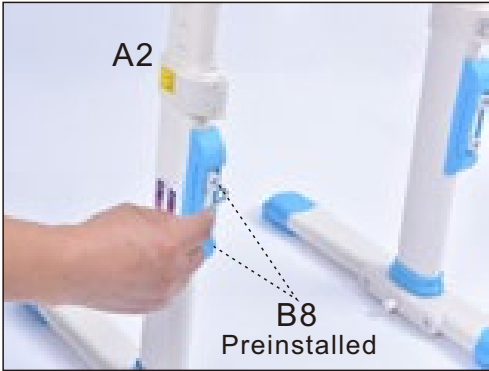
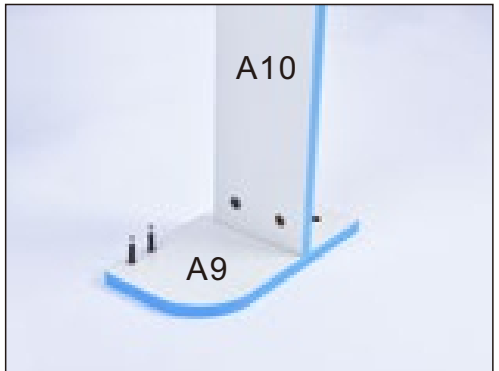
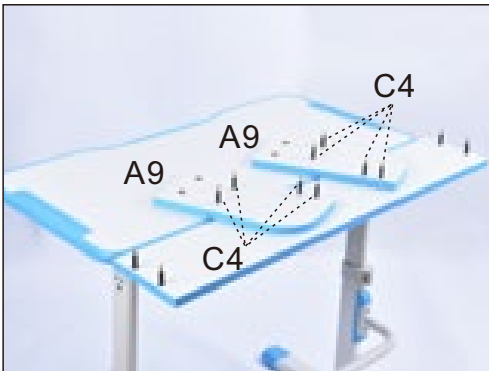
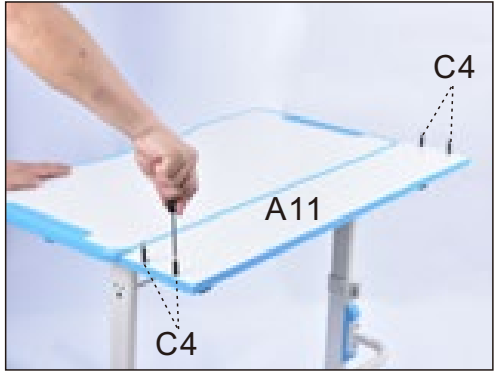
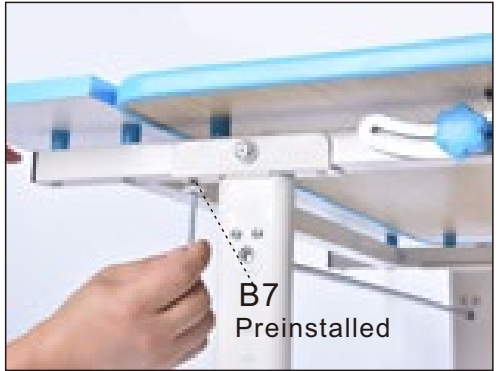
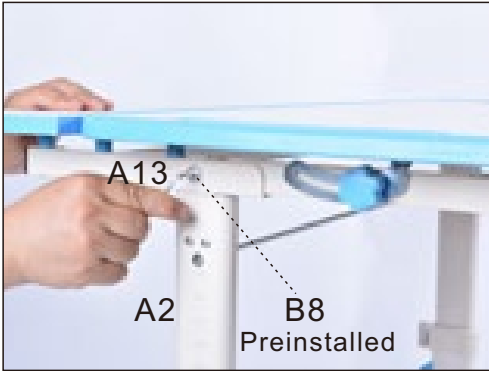

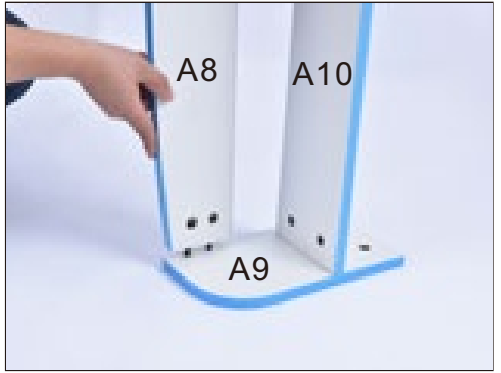
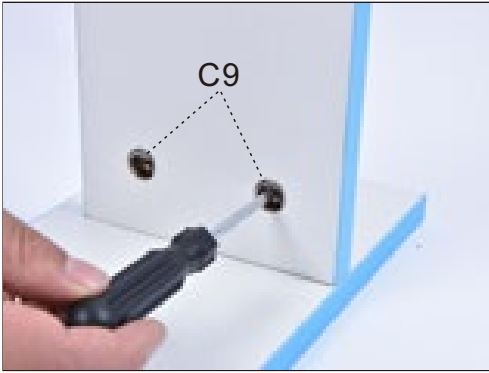

TABLE INSTALLATION









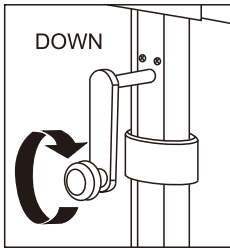
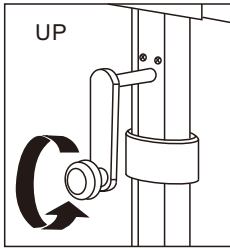

EN: Adjustable height according to hole position.

FR: Hauteur réglable en fonction de la position du trou.

DE: Einstellbare Höhe je nach Lochposition.

ES: Se puede ajustar la altura según la posición de los agujeros.

IT: Altezza regolabile in base alla posizione del foro.



UK

If you have any questions, please contact our customer care center.

Our contact details are below:



0044-800-240-4004



enquiries@mhstar.co.uk

IMPORTER ADDRESS:

MH STAR UK LTD

Unit 27, Perivale Park,
Horsenden lane South
Perivale, UB6 7RH

MADE IN CHINA

ES

Si tiene alguna pregunta, comuníquese con nuestro Centro de Atención al Cliente.

Nuestros datos de contacto son los siguientes:



0034-931294512



atencioncliente@aosom.es

Importador/Fabricante/REP:

Spanish Aosom, S.L.

C/Roc Gros, nº 15. 08550, Els Hostalets de
Balenyà, Spain.

B66295775

www.aosom.es

atencioncliente@aosom.es

TEL: 931294512

HECHO EN CHINA

FR

Si vous avez la moindre question, veuillez contacter notre centre d'assistance à la clientèle.

Nos coordonnées sont les suivantes:



0033-1-84166106



aosom@mhfrance.fr

Importé par/Fabricant/REP:

MH France

2, rue Maurice Hartmann
92130 Issy-les-Moulineaux
France

Fabriqué en Chine

<https://www.aosom.fr/>

PT

Se tiver alguma dúvida, por favor contacte o nosso Centro de Atendimento ao Cliente.

Os nossos dados de contacto são os seguintes:



0034-931294512



info@aosom.pt.

IMPORTADOR:

SPANISH AOSOM, S.L

C.ROC GROS N.15, 08550. ELS HOSTALETS DE BALENYÀ

TEL: 931294512 (SEG-SEX DAS 7:30H ÀS 16:30H)

INFO@AOSOM.PT

WWW.AOSOM.PT

DE

Wenn Sie Fragen haben, wenden Sie sich bitte an unser Kundendienstzentrum.

Unsere Kontaktdaten stehen unten:



0049-0(40)-88307530



service@aosom.de

Importeur/Hersteller/REP:

MH Handel GmbH

Wendenstraße 309

D-20537 Hamburg

Germany

IN CHINA HERGESTELLT

<https://www.aosom.de/>

IT

In caso di dubbio, si prega di contattare il nostro centro assistenza clienti.

I nostri dettagli di contatto sono di seguito:



0039-0249471447



clienti@aosom.it

IMPORTATO DA/Produttore/REP:

AOSOM Italy srl

Centro Direzionale Milanofiori

Strada 1 Palazzo F1

20057 Assago (MI)

P.I.: 08567220960

FATTO IN CINA

<https://www.aosom.it/>

