

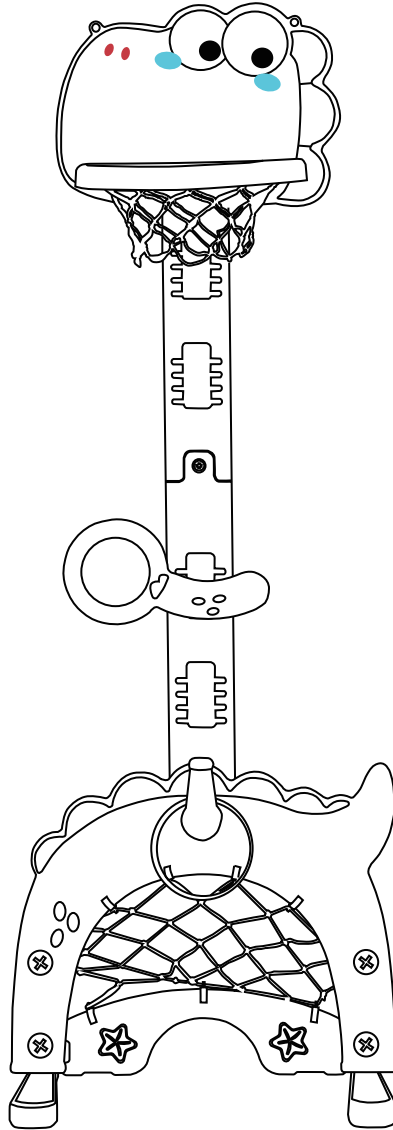

IN240300281V01_US_CA

331-051V00



ASSEMBLY INSTRUCTION INSTRUCTIONS D'ASSEMBLAGE

EN: Suitable for children of 3+ years old.

FR: Convient aux enfants de 3+ ans.

**EN: IMPORTANT, RETAIN FOR FUTURE REFERENCE: READ CAREFULLY.
FR: IMPORTANT: A LIRE ATTENTIVEMENT ET A CONSERVER POUR VOUS Y
REFRERER ULTERIEUREMENT**

EN

WARNING:

1. CHOKING HAZARD—Small parts. Not for children under 3 years.
2. Only allowed for adults to install, keep children away.
3. To be used under the direct supervision of an adult.
4. Check all the parts are well connected before use.
5. Regularly check and maintain the main components (suspenders, fasteners, fixings, etc.), otherwise it may tip over or cause a fall.
6. Installation area should be as wide as possible, flat and avoid dampness.
7. Keep away from fire.
8. Place the activity toy on a level surface at least 2 m from any structure or obstruction such as a fence, garage, house, overhanging branches, laundry lines or electrical wires.
9. Check all nuts and bolts for tightness and tighten when required.
10. Check all coverings for bolts and sharp edges and replace when required.
11. To replace defective parts in accordance with the manufacturer's instructions.

MAINTENANCE

1. Please wipe the surface stains of product with a dry cloth. If necessary, use mild soap or detergent to clean them. After wiping with a soft wet cloth, wipe them with a dry cloth. Do not use a strong acid-alkaline cleaning solution to clean them.
2. If not used for a long time, please put it in a cool and dry place and cover it with clean cloth or blanket.

FR

ATTENTION

1. RISQUE D'ÉTOUFFEMENT— Petites pièces. Déconseillé aux enfants de moins de 3 ans.
2. L'installation n'est autorisée qu'aux adultes, tenez les enfants à l'écart.
3. À utiliser sous la surveillance directe d'un adulte.
4. Vérifiez que toutes les pièces sont bien connectées avant utilisation.
5. Vérifiez et entretenez régulièrement les principaux composants (bretelles, attaches, fixations, etc.), sinon il peut se renverser ou provoquer une chute.
6. La zone d'installation doit être aussi large que possible, plate et éviter l'humidité.
7. Tenez à l'écart de la flamme.
8. Placez le jouet d'activité sur une surface plane à au moins 2 m de toute structure ou obstruction telle qu'une clôture, un garage, une maison, des branches en surplomb, des cordes à linge ou des fils électriques.
9. Vérifiez l'étanchéité de tous les écrous et boulons et serrez-les au besoin.
10. Vérifiez tous les revêtements pour les boulons et les arêtes vives et remplacez-les si nécessaire.
11. Remplacez les pièces défectueuses conformément aux instructions du fabricant.

MAINTENANCE

1. Veuillez essuyer les taches de surface du produit avec un chiffon sec. Si nécessaire, utilisez du savon doux ou du détergent pour le nettoyage. Après l'essuyage avec un chiffon doux et humide, essuyez-les avec un chiffon sec. N'utilisez pas une solution nettoyante fortement acide-alkaline pour le nettoyage.
2. Si vous ne l'utilisez pas pendant une longue période, placez-le dans un endroit frais et sec et couvrez-le d'un tissu ou d'une couverture propre.

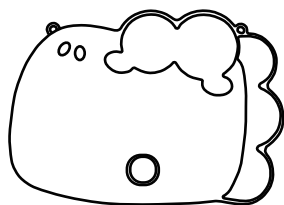

x1

A

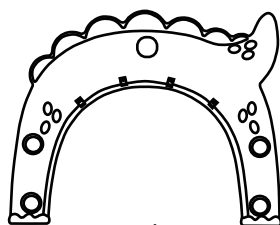

x1

B

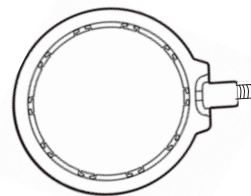

x1

C

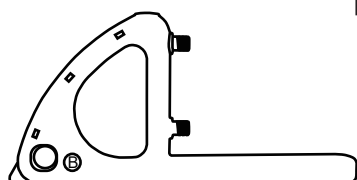

ABx1

D

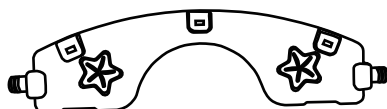

x1

E

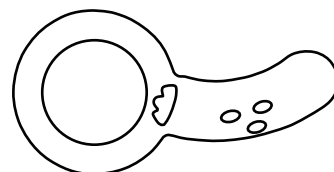

x1

F

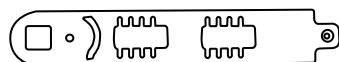

x1

G

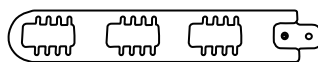

x1

H

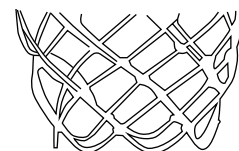

x1

I

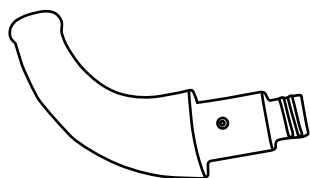

x1

J

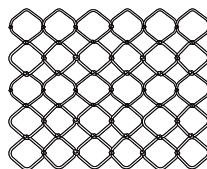

x1

K



x1

L



x1

M

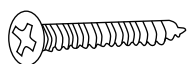

4*30mm
x1

N



x2

O



x6

P

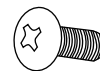

8*20mm
x2

Q

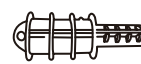

x1

R



x1

S



x13

T

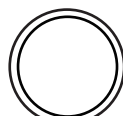

x3

U



x1

V

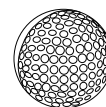

x2

W

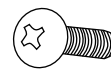

8*30mm
x1

X

P X2

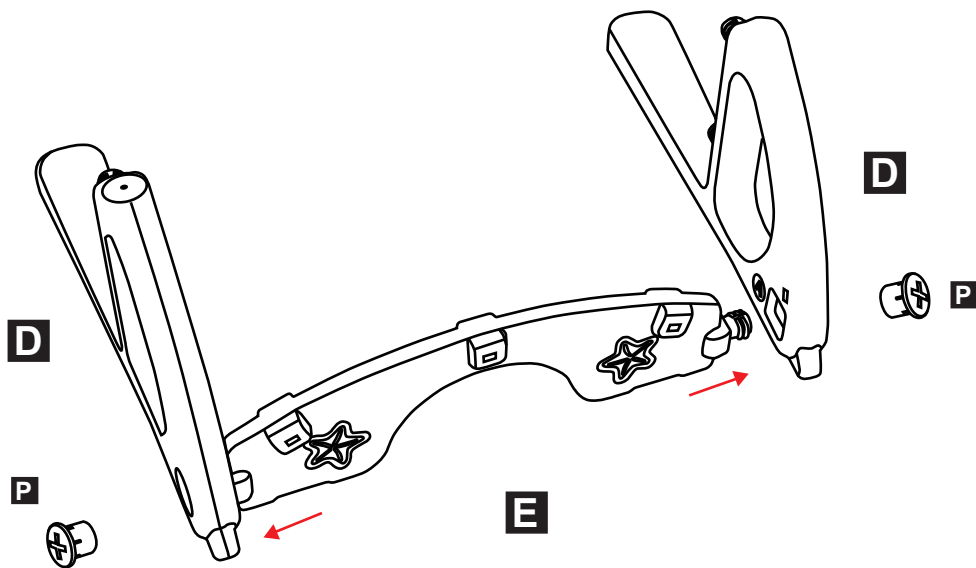

Q X2

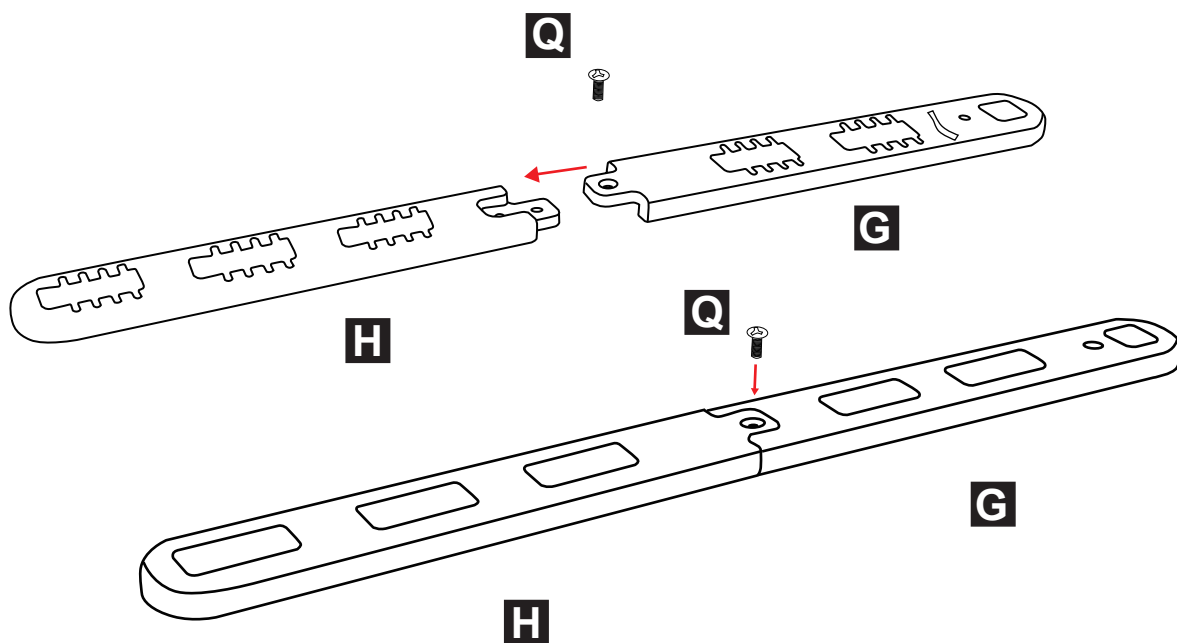

P X 4



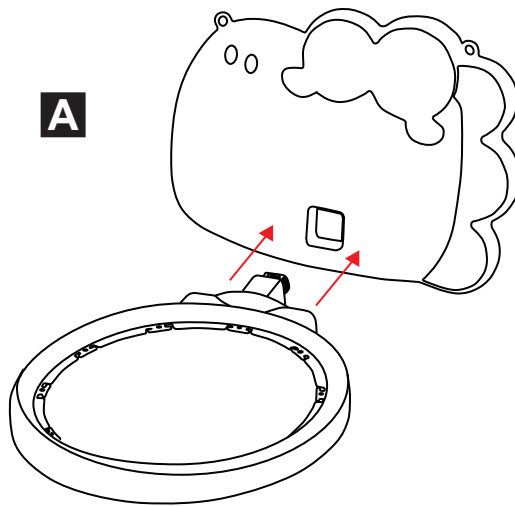

Water or sand

A

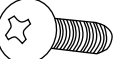

C

| |
|--|
|  X 2 |
|  |
| N X 1 |
|  |
| X X 1 |
|  |

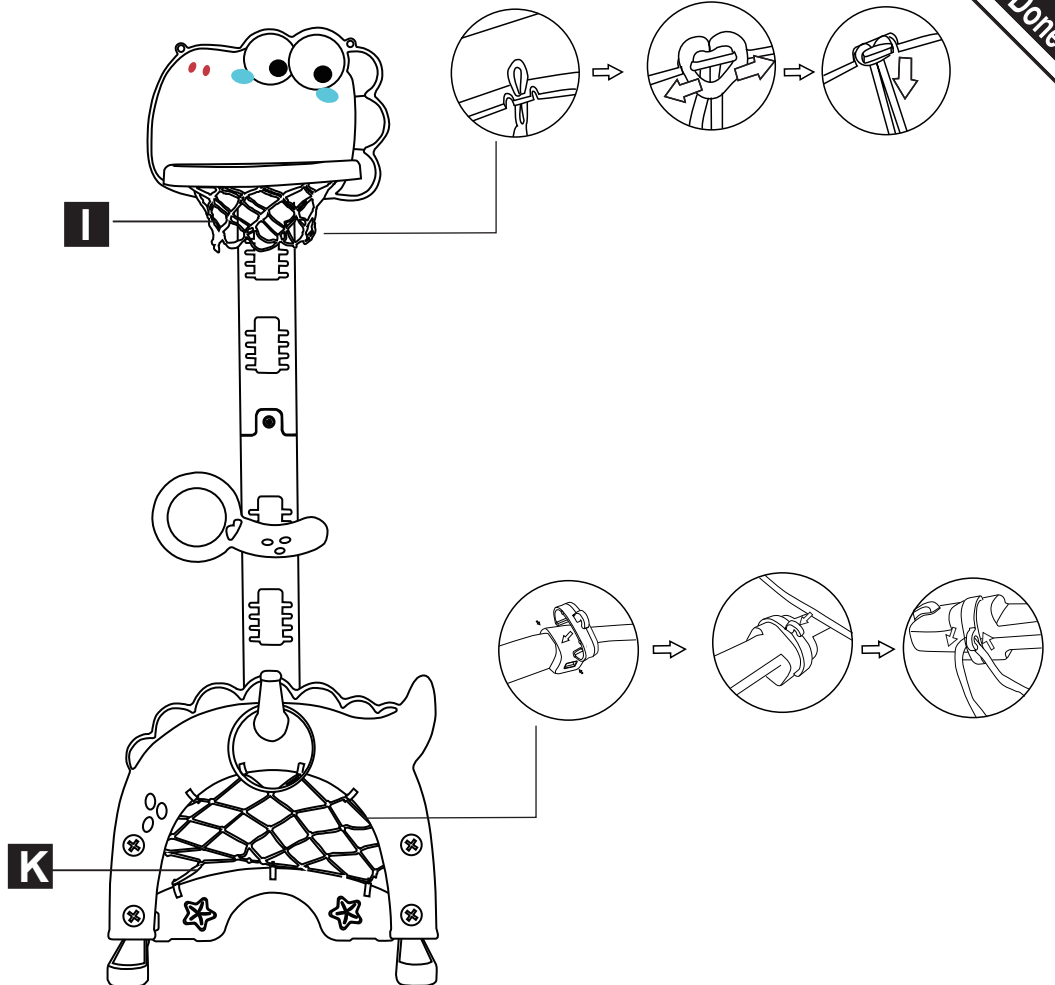
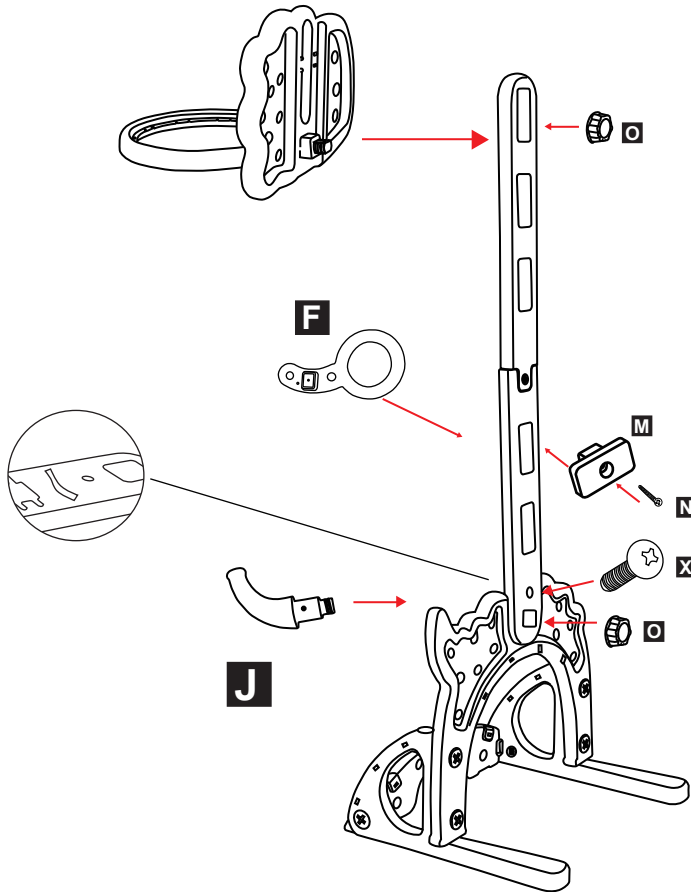

US

If you have any questions, please contact our customer care center.
Our contact details are below:



001-877-644-9366



customerservice@aosom.com

Imported by Aosom LLC
27150 SW Kinsman Rd Wilsonville, OR 97070 USA
MADE IN CHINA

CA

If you have any questions, please contact our customer care center.
Our contact details are below:

Si vous avez la moindre question, veuillez contacter notre centre d'assistance à la clientèle.
Nos coordonnées sont les suivantes:



416-792-6088



customerservice@aosom.ca

Imported by Aosom Canada Inc.
7270 Woodbine Avenue, Unit 307, Markham, Ontario Canada
L3R 4B9
MADE IN CHINA

Importé par Aosom Canada Inc.
7270 Woodbine Avenue, unité 307, Markham, Ontario Canada
L3R 4B9
FABRIQUÉ EN CHINE