

USER MANUAL

ProLite

LCD Monitor

ENGLISH

ProLite T2234MSC

Thank you very much for choosing the iiyama LCD monitor.

We recommend that you take a few minutes to read this comprehensive manual carefully before installing and switching on the monitor. Please keep this manual in a safe place for your future reference.



Dear user, we congratulate you on the purchase of your iiyama LCD.

For details on warranty and locally used pixel policies that apply directly after installation of your product please check the iiyama website.

To report a fault, please contact your local support centre found at www.iiyama.com/service

Things to check before you call the iiyama information line

- | if the power cable is connected securely and turned on?
- | if the display has been turned on?
- | if the signal cable is connected securely and the correct input selected?
- | if the computer has been restarted with the display connected?
- | if the graphics card is correctly installed with the latest drivers possible?
- | if the correct native resolution has been selected via 'Display Properties'?
- | If the R/G/B signal configuration is correct?
- | if the displays On Screen Menu is shown?
- | if the correct brightness and contrast settings have been set?
- | if given display tolerances and compatibility have been considered?
- | if via the On Screen Menu you have performed a Factory Reset/Recall?

Before reporting the screen defect, please prepare the following information/evidence:

- | model number *
- | purchase receipt and serial number *
- | name and address for collection
- | telephone/fax number, for availability during the day
- | convenient collection date (date, time)
- | short description of the defect

Important Note:

If there is no fault found in the collected equipment after inspection, the transferring party shall incur charges for transport and administration.

If you have checked all of the above and there is still no picture, call our information line for assistance in your country.

* see the identification plate on the back of the case.

CE MARKING DECLARATION OF CONFORMITY

This LCD monitor complies with the requirements of the EC/EU Directive 2014/30/EU "EMC Directive", 2014/35/EU "Low Voltage Directive", 2009/125/EC "ErP Directive" and 2011/65/EU "RoHS Directive".

Warning

This is a class A product. In a domestic environment this product may cause radio interference in which case the user may be required to take adequate measures.

IYAMA CORPORATION: Wijkemeerstraat 8, 2131 HA Hoofddorp, The Netherlands

Model No. : PLC2234



We recommend recycling of used product. Please contact your dealer or iiyama service center. Recycle information is obtained via the Internet, using the address: <http://www.iiyama.com>

You can access the Web page of different countries from there.

- We reserve the right to change specifications without notice.
- All trademarks used in this user manual are the property of their respective owners.
- Eprel registration number T2234MSC-B7X B : 999511

TABLE OF CONTENTS

| | |
|--|----|
| FOR YOUR SAFETY..... | 1 |
| SAFETY PRECAUTIONS..... | 1 |
| SPECIAL NOTES ON LCD MONITORS..... | 3 |
| CUSTOMER SERVICE..... | 3 |
| CLEANING..... | 3 |
| BEFORE YOU OPERATE THE MONITOR..... | 4 |
| FEATURES..... | 4 |
| CHECKING THE CONTENTS OF THE PACKAGE..... | 5 |
| SPECIAL NOTES ON THE TOUCH PANEL..... | 5 |
| INSTALLATION..... | 6 |
| CONTROLS AND CONNECTORS..... | 7 |
| CONNECTING YOUR MONITOR..... | 8 |
| COMPUTER SETTING..... | 10 |
| ADJUSTING THE VIEWING ANGLE..... | 12 |
| OPERATING THE MONITOR..... | 13 |
| ADJUSTMENT MENU CONTENTS..... | 15 |
| SCREEN ADJUSTMENTS..... | 19 |
| STANDBY FEATURE..... | 22 |
| TROUBLE SHOOTING..... | 23 |
| RECYCLING INFORMATION..... | 24 |
| APPENDIX..... | 25 |
| SPECIFICATIONS : ProLite T2234MSC-B7X B..... | 25 |
| DIMENSIONS..... | 26 |
| COMPLIANT TIMING..... | 27 |

FOR YOUR SAFETY

SAFETY PRECAUTIONS

WARNING

STOP OPERATING THE MONITOR WHEN YOU SENSE TROUBLE

If you notice any abnormal phenomena such as smoke, strange sounds or fumes, unplug the monitor and contact your dealer or iiyama service center immediately. Further use may be dangerous and can cause fire or electric shock.

NEVER REMOVE THE CABINET

High voltage circuits are inside the monitor. Removing the cabinet may expose you to the danger of fire or electric shock.

DO NOT PUT ANY OBJECT INTO THE MONITOR

Do not put any solid objects or liquids such as water into the monitor. In case of an accident, unplug your monitor immediately and contact your dealer or iiyama service center. Using the monitor with any object inside may cause fire, electric shock or damage.

INSTALL THE MONITOR ON A FLAT, STABLE SURFACE

The monitor may cause an injury if it falls or is dropped.

DO NOT USE THE MONITOR NEAR WATER

Do not use where water may be splashed or spilt onto the monitor as it may cause fire or electric shock.

OPERATE UNDER THE SPECIFIED POWER SUPPLY

Be sure to operate the monitor only with the specified power supply. Use of an incorrect voltage will cause malfunction and may cause fire or electric shock.

CORRECT USE OF THE AC ADAPTER

Use only the AC Adapter provided by iiyama. Any deviation from this by using another type of adapter may result in damage to the accessory and the monitor by fire or electric shock.

DO NOT DISASSEMBLE THE AC ADAPTER

Disassembling the AC Adapter may expose you to the danger of fire or electric shock.

PROTECT THE CABLES

Do not pull or bend the AC adapter, the power cable and signal cable. Do not place the monitor or any other heavy objects on the cables. If damaged, the cables may cause fire or electric shock.

ADVERSE WEATHER CONDITIONS

It is advisable not to operate the monitor during a heavy thunder storm as the continual breaks in power may cause malfunction. It is also advised not to touch the plug in these circumstances as it may cause electric shock.

CAUTION

INSTALLATION LOCATION

Do not install the monitor where sudden temperature changes may occur, or in humid, dusty or smoky areas as it may cause fire, electric shock or damage. You should also avoid areas where the sun shines directly on the monitor.

DO NOT PLACE THE MONITOR IN A HAZARDOUS POSITION

The monitor may topple and cause injury if not suitably located. Please also ensure that you do not place any heavy objects on the monitor, and that all cables are routed such that children may not pull the cables and possibly cause injury.

MAINTAIN GOOD VENTILATION

Ventilation slots are provided to keep the monitor from overheating. Covering the slots may cause fire. To allow adequate air circulation, place the monitor at least 10cm (or 4 inches) from any walls.

When removing the tilt stand, the ventilation slots on the back side of the monitor can be blocked. This may overheat the monitor and may cause fire or damage. Make sure to allow enough ventilation when removing the tilt stand. Operating the monitor on its back, side, upside down or on a carpet or any other soft material may also cause damage.

DISCONNECT THE CABLES WHEN YOU MOVE THE MONITOR

When you move the monitor, turn off the power switch, unplug the monitor and be sure the signal cable is disconnected. If you do not disconnect them, it may cause fire or electric shock.

UNPLUG THE MONITOR

If the monitor is not in use for a long period of time it is recommended that it is left unplugged to avoid accidents.

HOLD THE PLUG WHEN DISCONNECTING

To disconnect the AC adapter, the power cable or signal cable, always pull it by the plug. Never pull on the cable itself as this may cause fire or electric shock.

DO NOT TOUCH THE PLUG WITH WET HANDS

Pulling or inserting the plug with wet hands may cause electric shock.

WHEN YOU INSTALL THE MONITOR ON YOUR COMPUTER

Be sure the computer is strong enough to hold the weight of the monitor, otherwise, you may damage your computer.

CARE TO A HAND AND FINGERS!

- Careful attention is required not to catch your fingers or hands when you change the height or the angle.
- Injury can occur if care is not taken to avoid finger contact with the displays base when adjusting the height. (Just for height adjustable model.)

REMARK FOR 24/7 USAGE

This product is not specifically designed for 24/7 usage in all environments.

OTHERS

ERGONOMIC RECOMMENDATIONS

To eliminate eye fatigue, do not operate the monitor against a bright background or in a dark room. For optimal viewing comfort, the monitor should be just below eye level and 40-60 cm (16-24 inches) away from your eyes. When using the monitor over a prolonged time, a ten minute break every hour is recommended as looking at the screen continuously can cause eye strain.

SPECIAL NOTES ON LCD MONITORS

The following symptoms are normal with LCD monitors and do not indicate a problem.

NOTE

- When you first turn on the LCD monitor, the picture may not fit in the display area because of the type of computer that is used. In this case, adjust the picture position to the correct position.
- You may find slightly uneven brightness on the screen depending on the desktop pattern you use.
- Due to the nature of the LCD screen, an afterimage of the previous screen may remain after switching the image, when the same image is displayed for hours. In this case, the screen is recovered slowly by changing the image or turning off the Power Switch for some hours.

CUSTOMER SERVICE

NOTE

- If you have to return your unit for service and the original packaging has been discarded, please contact your dealer or iiyama service center for advice or replacement packaging.

CLEANING

WARNING

- If you drop any materials or liquids such as water into the monitor when cleaning, unplug the power cable immediately and contact your dealer or iiyama service center.

NOTE

- To protect the Touch screen surface, do not scratch or rub the screen with a hard object.
- Never use any of the following strong solvents. These will damage the cabinet and the Touch screen surface.
Abrasive cleaner Wax Solvent
- Touching the cabinet with any product made from rubber or plastic for a long time may cause degeneration or loss of paint on the cabinet.

CABINET

Stains can be removed with a cloth lightly moistened with a mild detergent solvent. Then wipe the cabinet with a soft dry cloth.

TOUCH SCREEN

Touch screen surface may be cleaned using a soft clean cloth moistened with mild window glass commercial cleaners or 50/50 mixture of water and IPA(ISO-propyl-alcohol). Don't use acid or alkaline solvent to clean the surface of the panel (or screen).

BEFORE YOU OPERATE THE MONITOR

FEATURES

- ◆ Supports Resolutions up to 1920 × 1080
- ◆ High Contrast 1000:1 (Typical) / Brightness 350cd/m² (Typical)
- ◆ Digital Character Smoothing
- ◆ Automatic Set-up
- ◆ Stereo Speakers
2 × 3W Stereo Speakers
- ◆ Standby Feature
- ◆ VESA Mounting Standard (100mm×100mm) Compliant
- ◆ IP65 Standard Compliant (Only front face)
- ◆ Anti fingerprint finish
- ◆ Palm rejection support

■ Windows8/8.1/10 touch environment

Basic touch operations can be performed under Windows 8/8.1/10.

However, please be informed that full touch functionality and normal operational performance are not guaranteed.

CHECKING THE CONTENTS OF THE PACKAGE

The following accessories are included in your package. Check to see if they are enclosed with the monitor. If anything is missing or damaged, please contact your local iiyama dealer or regional iiyama office.

- | | | |
|---------------------|----------------|---------------------|
| ■ Power Cable* | ■ AC Adapter* | ■ HDMI Cable |
| ■ DisplayPort Cable | ■ USB Cable | ■ Audio Cable |
| ■ Screw (M3x6mm) | ■ Safety Guide | ■ Quick Start Guide |

CAUTION * 1. TO USERS IN 120V AREA

The rating of the Power Cable enclosed in 120V area is 10A/125V. If you are using a power supply higher than this rating, then a power cable with a rating of 10A/250V must be used. However, all guarantees and warranties are void for any problems or damage caused by a power cable or AC adapter not supplied by iiyama.

2. Applicable AC Adapter

AC Adapter Type Name : ADP-50YH B (DELTA ELECTRONICS, INC.)
SOY-1200500-327 (Shenzhen SOY Technology Co., Ltd.)

3. An approved power cable greater or equal to H05VVF, 3G, 0.75mm² must be used.

SPECIAL NOTES ON THE TOUCH PANEL

CAUTION

Permanent damage can occur if Sharp Edged, Pointed or Metal items are used to activate Touch. This could invalidate any remaining warranty.

We recommend you use a plastic stylus (tip R0.8 or over) or finger.

INSTALLATION

WARNING ■ Before installation, make sure the wall, ceiling or desktop arm is strong enough to hold the necessary weight of the display and the mount.

< WALL MOUNTING >

WARNING When you use with the wall mounting, in consideration of thickness of the mounting stage, tighten the M4 Screws (4pcs) which “L” length is 8mm to fasten the monitor. Using the screw longer than this may cause electric shock or damage because it may contact with the electrical parts inside the monitor.

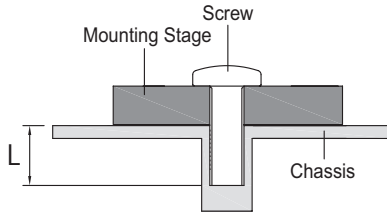

< BUILT-IN EQUIPMENT >

WARNING This product is not designed for the purpose of being used in high temperature environment.

If the product is placed in an external cabinet, you need to design cooling fans and vents to keep the temperature low enough to fit in the product temperature specification.

< ROTATING THE MONITOR >

This monitor is designed to be compatible in landscape, portrait and face-up modes.

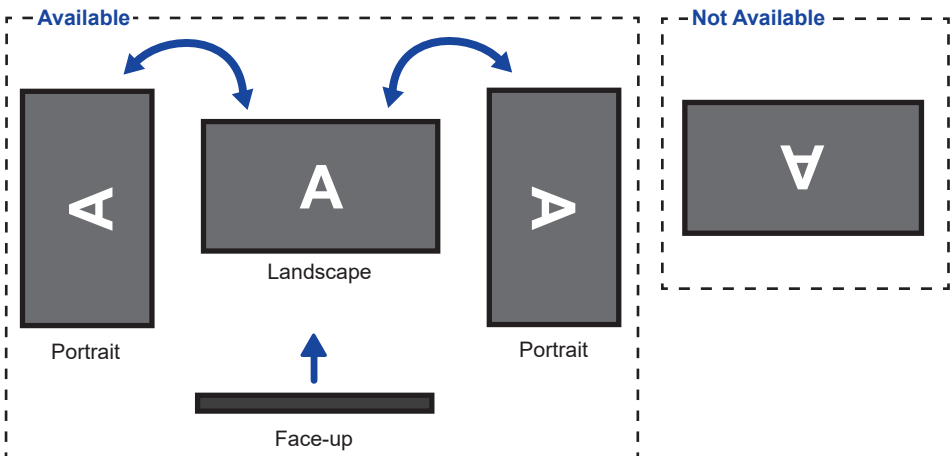

CONTROLS AND CONNECTORS

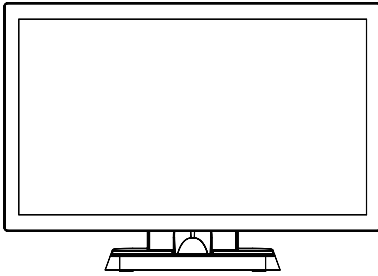

<Front>

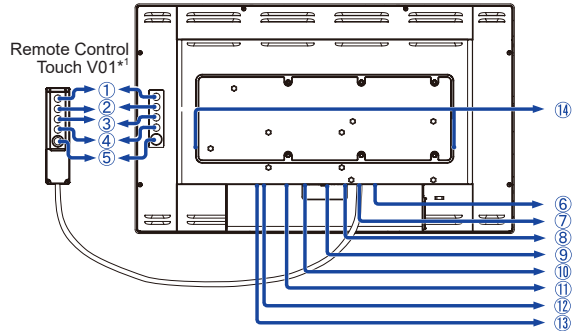

<Back>

ENGLISH

- ① Menu (MENU) *
 - ② Scroll Up / Brightness (Δ) *
 - ③ Scroll Down / Mute (∇) *
 - ④ Select (SELECT) *
 - ⑤ Power Switch (⏻) *
 - ⑥ USB Connector (USB)
 - ⑦ Remote Control Touch V01 Connector (RJ11)
 - ⑧ Audio Connector (AUDIO)
 - ⑨ VGA Connector (VGA)
 - ⑩ HDMI Connector (HDMI)
 - ⑪ DisplayPort Connector (DP)
 - ⑫ Connector for AC Adapter(--- : Direct current) (DC)
 - ⑬ Power Indicator
- NOTE** Green: Normal operation
Orange: Standby mode
- ⑭ Speakers

* Remote Control Touch V01 is optional.

CONNECTING YOUR MONITOR

- ① Ensure that both the computer and the monitor are switched off.
- ② Connect the computer to the monitor with the signal cable.
- ③ Connect the monitor to the audio equipment with the Audio Cable for computer when using the audio features.
- ④ Connect the computer to the monitor with the USB Cable.
- ⑤ Connect the monitor cable to the Remote Control Touch V01 (option), if necessary.
- ⑥ Connect the AC Adapter to the monitor and the Power Cable to the AC Adapter first and then connect to the power source.
- ⑦ Turn on your monitor and computer.

NOTE

- Make sure that the building installation has a circuit breaker of 120/240V, 20A (maximum).
- The signal cables used for connecting the computer and monitor may vary with the type of computer used. An incorrect connection may cause serious damage to both the monitor and the computer. The cable supplied with the monitor is for a standard connector. If a special cable is required please contact your local iiyama dealer or regional iiyama office.
- Make sure you tighten the finger screws at each end of the Signal Cable.
- The Class I pluggable equipment Type A must be connected to protective earth.
- The socket-outlet shall be installed near the equipment and shall be easily accessible.

[Example of Connection]

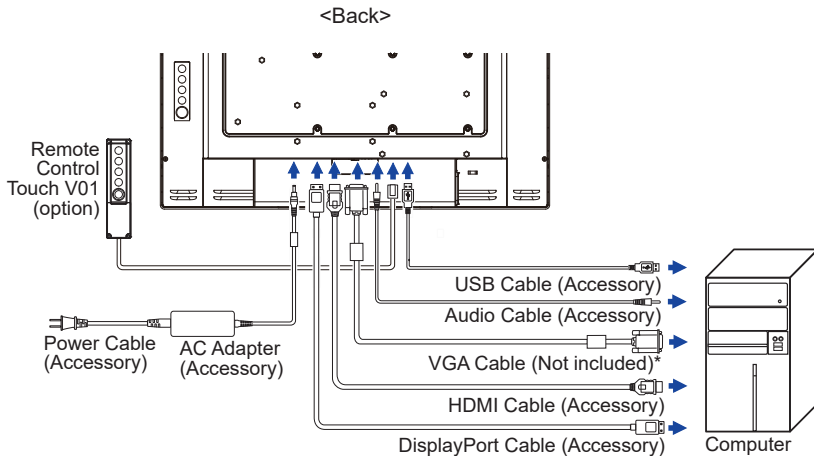

- * VGA cable is not supplied with the monitor. If you use low quality VGA cable, it may cause a result of electro-magnetic interference. Please contact the iiyama Support Centre in your country if you wish to connect the monitor via the VGA input.

[Fitting and Removal of Cable Cover]

Put a piece of soft cloth on the table beforehand to prevent the monitor from being scratched. Lay the monitor flat on a table with front face down.

< Removal >

- ① Move the stand into position as shown in Step1.
- ② Remove the cable cover as shown in Step2.

< Fitting >

- ① As shown in Step3, connect the cables and put those through the cable holes.
- ② As shown in Step4, place the cable cover and fix it firmly using a screw.

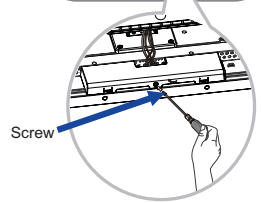
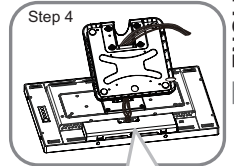
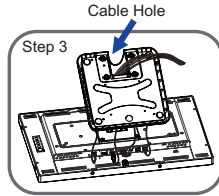
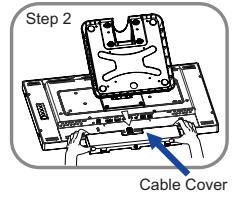
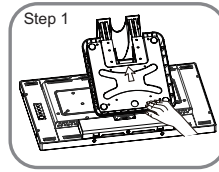

[Collect Cables]

- ① Put the cables through the cable holes.
- ② Collect cables at the back of the stand.

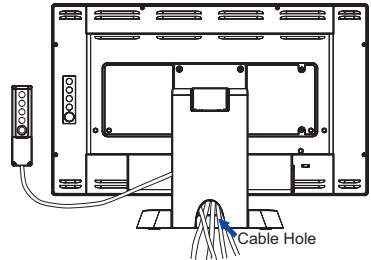

COMPUTER SETTING

■ Signal Timing

Change to the desired signal timing listed on page 27: COMPLIANT TIMING.

■ Windows XP/Vista/7/8/8.1/10 Plug & Play

The iiyama LCD monitor complies with DDC2B of VESA standard. The Plug & Play function runs on Windows XP/Vista/7/8/8.1/10 by connecting the monitor to DDC2B compliant computer with the Signal Cable supplied.

For installation on Windows XP: The monitor Information File for iiyama monitors may be necessary for your computer and obtained via the Internet, using the address:

<http://www.iiyama.com>

NOTE

- For additional information on how to download the driver for your touch screen monitor, please access the internet site noted above.
- Monitor Drivers are not required in most cases for Macintosh or Unix operating systems. For further information, please contact your computer dealer first for advice.

■ Procedure for turning ON the Power Switch

Turn ON the monitor first, and then the computer.

■ Touch screen driver software

Touch screen driver software and system may not start when you start your computer while touching the screen.

Touch screen driver software may not run due to the power saving function depending on the BIOS of your computer. In this case, set the power saving function to off.

■ TOUCH support operation system

Microsoft Windows XP (64 bit and 32 bit)

Microsoft Windows Vista (64 bit and 32 bit)

Microsoft Windows 7 (64 bit and 32 bit)

Microsoft Windows 8 / 8.1 / 10 (64 bit and 32 bit)

Microsoft Windows CE 2.13 / 3.0, net 6.0

Mac OS X V10.4/10.5/10.6 & above

Linux (Kernel2.4, 2.6x) & above

Not support earlier versions.

| | Windows8/8.1/10 | Windows7* ⁵ | Windows7* ⁴ | Vista | XP |
|---------------------------------|-----------------|------------------------|------------------------|-------|----|
| Default mouse* ¹ | ○ | ○ | ○ | ○ | ○ |
| Touch digitizer* ² | ○ | ○ | ○ | ○ | × |
| Windows7 gestures* ³ | ○ | ○ | × | × | × |

| | 2K | Windows CE | XP Embedded | Mac OS X | Linux |
|---------------------------------|----|------------|-------------|----------|-------|
| Default mouse* ¹ | ○ | ○ | ○ | ○ | ○ |
| Touch digitizer* ² | × | × | × | × | × |
| Windows7 gestures* ³ | × | × | × | × | × |

*¹ Default mouse (click, drag, double-click and right-click)

*² Touch digitizer (click, drag /selection, double-click, right-click, flick and visual feedback)

*³ Digitizer with Windows 7 touch gestures

*⁴ Windows 7 - Starter and Home Basic version

*⁵ Windows 7 - Home Premium, Professional, Enterprise and Ultimate versions

■ Touch Input Settings in Dual Screen Mode

① Connect the primary monitor to the computer first.

Set Control Panel > Hardware and Sound > Tablet PC Settings > Display > Setup.

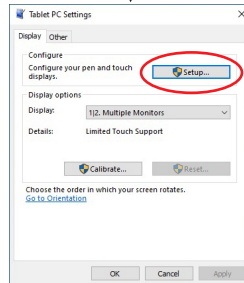
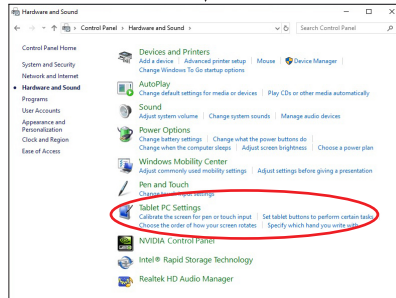
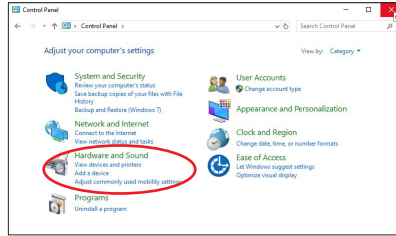

The following message will appear on the screen. Please follow the instructions.

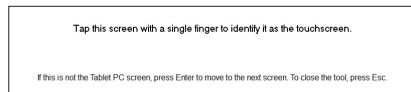

② After setting ①, connect a second monitor and perform the setup as in ①.

NOTE The monitors are recognized as dual-display, and touch operation cannot be performed on two monitors at the same time.
You can perform touch operation on only one of the monitors.

ADJUSTING THE VIEWING ANGLE

- For optimal viewing it is recommended to look at the full face of the monitor.
- Hold the panel so that the monitor does not topple when you change the monitor's angle.
- You are able to adjust the monitor's angle up to 95° upward, 25° downward.

- NOTE**
- Do not touch the LCD screen when you change the angle. It may cause damage or break the LCD screen.
 - Careful attention is required not to pinch your fingers or hands into the moving part of the stand when you change the angle.

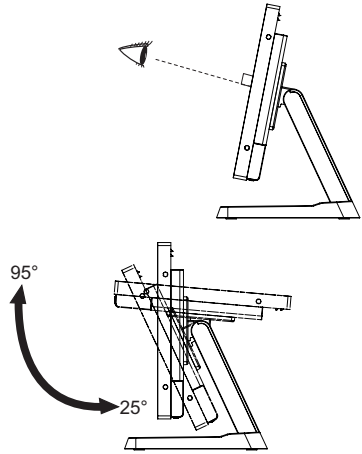

OPERATING THE MONITOR

To create the best picture, your iiyama LCD monitor has been preset at the factory with the COMPLIANT TIMING shown on page 27. You are also able to adjust the picture by following the button operation shown below. For more detailed adjustments, see page 19 for SCREEN ADJUSTMENTS.

- 1 Press the MENU Button to start the On Screen Display feature. There are additional Menu items which can be switched by using the Δ / ∇ Buttons.

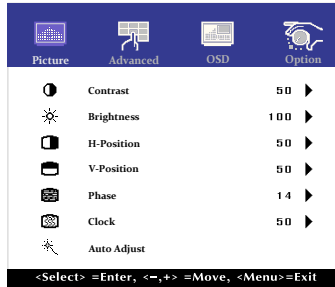

- 2 Select the Menu item which contains the adjustment icon relating to the adjustment you want to make. Use the SELECT Button to highlight the desired adjustment icon.
- 3 Use the Δ / ∇ Buttons to make the appropriate adjustment or setting.
- 4 Press the MENU Button to leave the menu, and the settings you just made would be automatically saved.

For example, to correct for vertical position, select Menu item of Picture. Then, select V-Position by using the SELECT Button.

Use the Δ / ∇ Buttons to change the vertical position settings. The vertical position of the overall display should be changing accordingly while you are doing this.

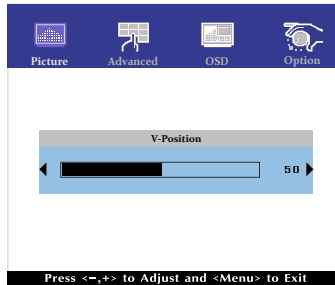

Press the MENU Button lastly, it ends, all changes are saved in the memory.

NOTE

- When button operations are aborted during adjustment, On-Screen Display disappears when the time set for the OSD Timeout has passed.
- MENU button can be used to return previous menu item.
- Any changes are automatically saved in the memory when the On Screen Display disappears. Turning off the power should be avoided while using the Menu.
- Adjustments for H/V-Position, Clock and Phase are saved for each signal timing. Except for these adjustments, all other adjustments have only one setting which applies to all signal timings.

Direct

● LOCK MODE:

Simultaneously press the MENU button and the ▽ button when an image is displayed through VGA, HDMI or DisplayPort.

* The OSD menu is not displayed when the OSD is locked. Press the MENU button and the ▽ button simultaneously again.

The following OSD menu is displayed.

| Adjustment Item | Problem / Option | |
|-----------------|------------------|-------------------------------|
| POWER | Active | The POWER SWITCH is Locked. |
| | Inactive | The POWER SWITCH is Unlocked. |
| OSD | Active | The OSD menu is Locked. |
| | Inactive | The OSD menu is Unlocked. |









































NOTE When the lock function is enabled and there is no signal (standby mode), pressing the menu button displays the input selection menu and enables input selection.

● TOUCH FUNCTION DISABLE:

ON: Pressing and holding of the MENU Button and the SELECT Button at the same time when the Menu is not displayed, message "TOUCH DISABLE" will appear on the top right corner.

OFF: Pressing and holding of the MENU Button and the SELECT Button at the same time for about 5 seconds when the Menu is not displayed, till "TOUCH DISABLE" disappears.

ADJUSTMENT MENU CONTENTS

| Adjustment Item | Problem / Option | Button to Press | | | | | | | | | | | | | | | | | | | | | | | | | | | | | | | | |
|--|--|---|---------|----------|-----|--------|---|----------|----|---|---|------------|-----|---|---|------------|----|---|---|------------|----|---|---|-------|-----|--|---|-------|----|---|---|-------------|--|--|
| <div style="display: flex; align-items: center;">  <div style="margin-left: 10px;"> <h3>Picture</h3> </div> </div> <div style="margin-top: 10px;"> <table border="1" style="width: 100%; border-collapse: collapse; text-align: center;"> <thead> <tr> <th style="width: 25%;">Picture</th> <th style="width: 25%;">Advanced</th> <th style="width: 25%;">OSD</th> <th style="width: 25%;">Option</th> </tr> </thead> <tbody> <tr> <td></td> <td>Contrast</td> <td>50</td> <td>▶</td> </tr> <tr> <td></td> <td>Brightness</td> <td>100</td> <td>▶</td> </tr> <tr> <td></td> <td>H-Position</td> <td>50</td> <td>▶</td> </tr> <tr> <td></td> <td>V-Position</td> <td>50</td> <td>▶</td> </tr> <tr> <td></td> <td>Phase</td> <td>1.4</td> <td></td> </tr> <tr> <td></td> <td>Clock</td> <td>50</td> <td>▶</td> </tr> <tr> <td></td> <td>Auto Adjust</td> <td></td> <td></td> </tr> </tbody> </table> <p style="text-align: center; font-size: small; margin-top: 5px;"><Select> =Enter, <-,+> =Move, <Menu> =Exit</p> </div> | | | Picture | Advanced | OSD | Option |  | Contrast | 50 | ▶ |  | Brightness | 100 | ▶ |  | H-Position | 50 | ▶ |  | V-Position | 50 | ▶ |  | Phase | 1.4 | |  | Clock | 50 | ▶ |  | Auto Adjust | | |
| Picture | Advanced | OSD | Option | | | | | | | | | | | | | | | | | | | | | | | | | | | | | | | |
|  | Contrast | 50 | ▶ | | | | | | | | | | | | | | | | | | | | | | | | | | | | | | | |
|  | Brightness | 100 | ▶ | | | | | | | | | | | | | | | | | | | | | | | | | | | | | | | |
|  | H-Position | 50 | ▶ | | | | | | | | | | | | | | | | | | | | | | | | | | | | | | | |
|  | V-Position | 50 | ▶ | | | | | | | | | | | | | | | | | | | | | | | | | | | | | | | |
|  | Phase | 1.4 | | | | | | | | | | | | | | | | | | | | | | | | | | | | | | | | |
|  | Clock | 50 | ▶ | | | | | | | | | | | | | | | | | | | | | | | | | | | | | | | |
|  | Auto Adjust | | | | | | | | | | | | | | | | | | | | | | | | | | | | | | | | | |
| Contrast | Too dull Too intense |  △  ▽ | | | | | | | | | | | | | | | | | | | | | | | | | | | | | | | | |
| Brightness* ¹ | Too dark Too bright |  △  ▽ | | | | | | | | | | | | | | | | | | | | | | | | | | | | | | | | |
| H-Position* ⁴ |  Too left  Too right |  △  ▽ | | | | | | | | | | | | | | | | | | | | | | | | | | | | | | | | |
| V-Position* ⁴ |  Too low  Too high |  △  ▽ | | | | | | | | | | | | | | | | | | | | | | | | | | | | | | | | |
| Phase* ^{2,4} | To correct flickering text or lines |  △  ▽ | | | | | | | | | | | | | | | | | | | | | | | | | | | | | | | | |
| Clock* ^{2,4} |  Too narrow  Too wide |  △  ▽ | | | | | | | | | | | | | | | | | | | | | | | | | | | | | | | | |
| Auto Adjust* ^{3,4} | Adjust H/V-Position, Clock and Phase automatically. | | | | | | | | | | | | | | | | | | | | | | | | | | | | | | | | | |

*1 Adjust the Brightness when you are using the monitor in a dark room and feel the screen is too bright.

*2 See page 19 for SCREEN ADJUSTMENTS.











*3 For best results, use the Auto Adjust in conjunction with the adjustment pattern. See page 19 for SCREEN ADJUSTMENTS.

*4 Only Analog Input.

Direct

You can skip the Menu items and directly display an adjustment scale by using the following button operations.

- Brightness: Press the △ Button when the Menu is not displayed.

| Adjustment Item | | Problem / Option | | Button to Press |
|-----------------|---|------------------|--|--|
| Color Temp | 5500 | Greenish white | | |
| | 6500 | Reddish white | | |
| | 7500 | Yellowish white | | |
| | 9300 | Bluish white | | |
| | User | Red | Too weak |   |
| | Green | Too strong |   | |
| | Blue | | | |
| Sharpness | <p>You can change the picture quality from 0 to 100 (soft to sharp). Press the  Button to change the picture quality in numerical order. Press the  Button to change the picture quality in reverse numerical order. Adjust the picture quality at resolutions of less than 1920 x 1080. You can change the picture quality.</p> | | |     |



Advanced

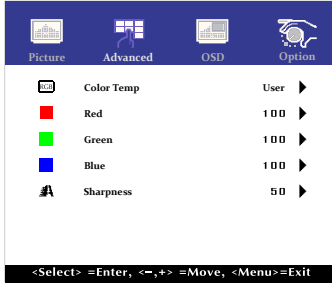

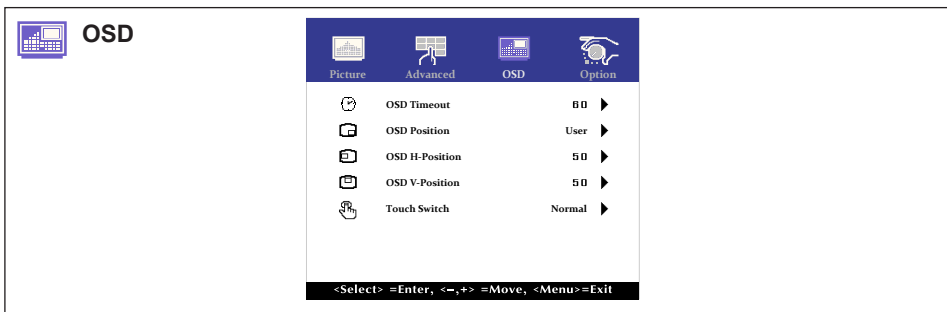

| Adjustment Item | Problem / Option | Button to Press |
|-----------------|---|--|
| OSD Timeout | You can set the OSD display duration time between 5 and 60 seconds. | |
| OSD Position | You can set the OSD position. User (Upper left / Lower left / Upper right / Lower right / Center) | |
| OSD H-Position | OSD is too left | |
| | OSD is too right | |
| OSD V-Position | OSD is too low | |
| | OSD is too high | |
| Touch Switch * | Normal | Normal touch (with bare hands or stylus device) |
| | Glove | Touch with gloved hand (Supports thickness +2mm) |
| | Through-Glass | Touch through glass (Supports thickness +6mm) |

* Please turn on the power and set the Touch Switch after the monitor installation is completed. Turning on the power and setting the Touch Switch before the monitor installation may cause misalignment or malfunction of the touch calibration.



Option

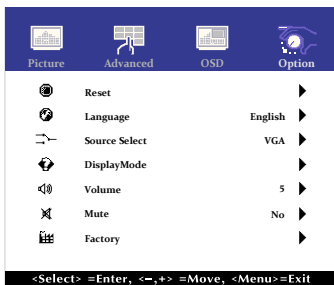

| Adjustment Item | Problem / Option | | Button to Press | |
|---|---|--|-----------------|---------------------|
| Reset | No | Return to Menu. | | |
| | Yes | Factory-preset data is restored. | | |
| Language | English | English | Español | Spanish |
| | Français | French | 日本語 | Japanese |
| | Deutsch | German | 繁體中 | Traditional Chinese |
| | Italiano | Italian | 簡中 | Simplified Chinese |
| Source Select Direct | Auto | Search for an available input source and select automatically. | | |
| | VGA | Select the analog input. | | |
| | HDMI | Select the digital(HDMI) input. | | |
| | DP | Select the digital(DisplayPort) input. | | |
| <p>NOTE However it will automatically be selected when just one source is using. In Standby Mode input switching is disabled. Input source is fixed, not selected automatically when VGA, HDMI and DisplayPort which are selected.</p> | | | | |
| Display Mode | Displays information regarding the current input signal coming from the graphic card in your computer. | | | |
| | <p>NOTE See your graphic card user guide for more information about changing the resolution and refresh.</p> | | | |
| Volume | Too soft | | | |
| | Too loud | | | |
| Mute Direct | No | Return the sound volume to the previous level. | | |
| | Yes | Turn off the sound temporarily. | | |
| Factory | This function is for service personnel only and therefore the operation is not available. | | | |

Direct

You can skip the Menu items and directly display an option setting screen by using the following button operations.

- Source Select : Pressing and holding of the SELECT Button for about 5 seconds when the Menu is not displayed.
By pressing the SELECT Button during standby mode, the Source Selected menu will be displayed.
- Mute: Press the ▽ Button when the Menu is not displayed.

SCREEN ADJUSTMENTS

Adjust the image by following the procedure below to get the desired picture when selecting Analog input.

- The screen adjustments described in this manual are designed to set image position and minimize flicker or blur for the particular computer in use.
- The monitor is designed to provide the best performance at resolution of 1920 × 1080, but can not provide the best at resolutions of less than 1920 × 1080 because the picture is automatically stretched to fit the full screen. It is recommended to operate at resolution of 1920 × 1080 in normal use.
- Displayed text or lines will be blurred or irregular in thickness when the picture is stretched due to the screen enlargement process.
- It is preferable to adjust the image position and frequency with the monitor controls, rather than the computer software or utilities.
- Perform adjustments after a warm-up period of at least thirty minutes.
- Additional adjustments may be required after the Auto Adjust depending on the resolution or signal timing.
- The Auto Adjust may not work correctly when displaying the picture other than the screen adjustment pattern. In this case, manual adjustments are required.

There are two ways to adjust the screen. One way is automatic adjustment for H/V-Position, Clock and Phase. The other way is performing each adjustment manually.

Perform the Auto Adjust first when the monitor is connected to a new computer, or resolution is changed. If the screen has a flicker or blur, or the picture does not fit in the display area after performing the Auto Adjust, manual adjustments are required. Both adjustments should be made by using the screen adjustment pattern (Test.bmp) obtained via the iiyama web site (<http://www.iiyama.com>).

Adjust the image by following the procedure below to get the desired picture.

This manual explains adjustment under Windows® OS.

- ① **Display the picture at the optimum resolution.**
- ② **Enter the Test.bmp (screen adjustment pattern) to wallpaper.**

- NOTE**
- Consult the appropriate documentation for doing this.
 - Set the display position to center in the wallpaper setting dialogue box.

[Adjustment pattern]

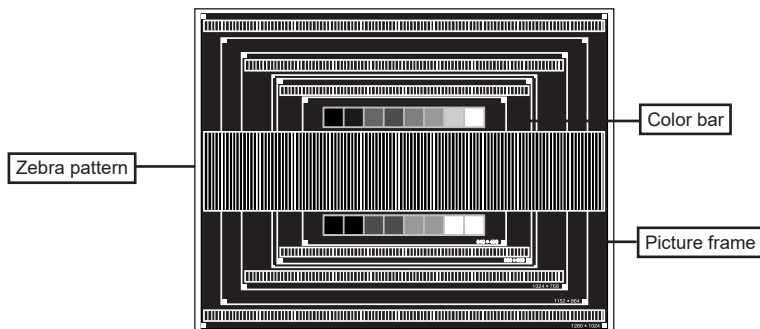

- ③ Perform the auto adjustment. (Auto Adjust)
- ④ Adjust the image manually by following procedure below when the screen has a flicker or blur, or the picture does not fit in the display area after performing the Auto Adjust.
- ⑤ Adjust the V-Position so that the top and bottom of the picture frame will fit to the display area.

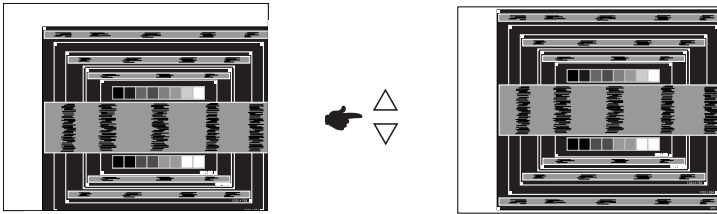

- ⑥ 1) Adjust the H-Position so that the left side of the picture frame will move to the left edge of the display area.

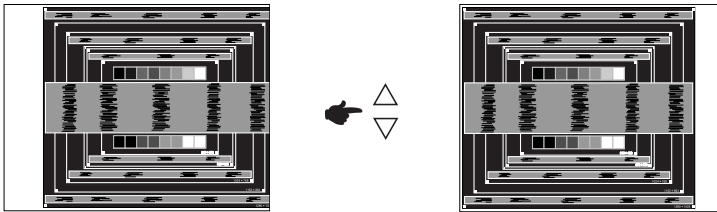

- 2) Stretch the right side of the picture frame to the right edge of the display area by adjusting the Clock.

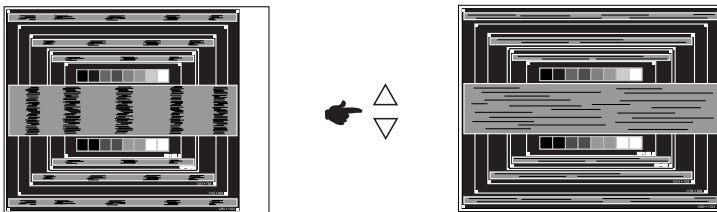
**NOTE**

- When the left side of the picture frame moves apart from the left edge of the display area during the Clock adjustment, adjust steps 1) and 2).
- Another way to make the Clock adjustment is to correct the vertical wavy lines in the zebra pattern.
- The picture may flicker during the Clock, H/V-Position adjustment.
- In case the picture frame is bigger or smaller than the data display area after the Clock adjustment, repeat steps from ③.

- ⑦ **Adjust the Phase to correct horizontal wavy noise, flicker or blur in the zebra pattern.**

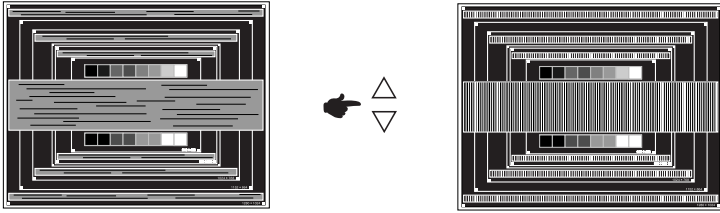

NOTE

- In case the strong flicker or blurs remain on a part of the screen, repeat steps ⑥ and ⑦ because the Clock may not be adjusted correctly.
- Adjust the H-Position after the Phase adjustment if the horizontal position moves during the adjustment.

- ⑧ **Adjust the Brightness and Color to get the desired picture after you complete the Clock and Phase adjustments.**

Put back your favorite wallpaper.

STANDBY FEATURE

This product features the standby function. When your computer is not in use, the standby feature will automatically reduce the power consumption of your monitor.

There is a standby step the monitor takes as described below. The standby function, including any timer settings is configured by the operating system. Check your operating system manual for information on how this can be configured.

■ Standby Mode

When the video signal from the computer is off, the monitor enters into Standby Mode which reduces the power consumption to less than 1.5W*. The screen becomes dark, and the power indicator turns to orange. From Standby Mode, the image reappears in several seconds when either the keyboard or the mouse are touched again.

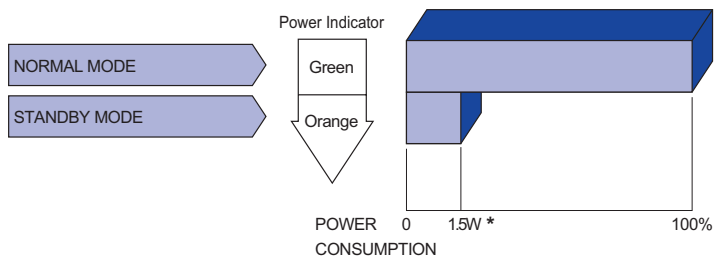

* When the USB devices are not connected.

TROUBLE SHOOTING

If the monitor fails to operate correctly, please follow the steps below for a possible solution.

1. Perform the adjustments described in OPERATING THE MONITOR, depending on the problem you have. If the monitor does not get a picture, skip to 2.
2. Consult the following items if you cannot find an appropriate adjustment item in OPERATING THE MONITOR or if the problem persists.
3. If you are experiencing a problem which is not described below or you cannot correct the problem, discontinue using the monitor and contact your dealer or iiyama service center for further assistance.

| Problem | Check |
|---|---|
| ① The picture does not appear. (Power indicator does not light up.) (Power indicator is green.) (Power indicator is orange.) | <input type="checkbox"/> The AC Adapter is firmly seated in the connector. <input type="checkbox"/> The Power Cable is firmly seated in the socket of the AC Adapter. <input type="checkbox"/> The Power Cable is firmly seated in the socket. <input type="checkbox"/> The Power Switch is turned ON. <input type="checkbox"/> The AC socket is live. Please check with another piece of equipment. <input type="checkbox"/> If the blank screen saver is in active mode, touch the keyboard or the mouse. <input type="checkbox"/> Increase the Contrast and/or Brightness. <input type="checkbox"/> The computer is ON. <input type="checkbox"/> The Signal Cable is properly connected. <input type="checkbox"/> The signal timing of the computer is within the specification of the monitor. <input type="checkbox"/> If the monitor is in standby mode, touch the keyboard or the mouse. <input type="checkbox"/> The computer is ON. <input type="checkbox"/> The Signal Cable is properly connected. <input type="checkbox"/> The signal timing of the computer is within the specification of the monitor. |
| ② The screen is not synchronized. | <input type="checkbox"/> The Signal Cable is properly connected. <input type="checkbox"/> The signal timing of the computer is within the specification of the monitor. |
| ③ The screen position is not in the center. | <input type="checkbox"/> The signal timing of the computer is within the specification of the monitor. |
| ④ The screen is too bright or too dark. | <input type="checkbox"/> The video output level of the computer is within the specification of the monitor. |
| ⑤ The screen is shaking. | <input type="checkbox"/> The power voltage is within the specification of the monitor. <input type="checkbox"/> The signal timing of the computer is within the specification of the monitor. |
| ⑥ No sound. | <input type="checkbox"/> The audio equipment (computer etc.) is ON. <input type="checkbox"/> The Audio Cable is properly connected. <input type="checkbox"/> The Volume is turned up. <input type="checkbox"/> The Mute is OFF. <input type="checkbox"/> The audio output level of the audio equipment is within the specification of the monitor. |
| ⑦ The sound is too loud or too quiet. | <input type="checkbox"/> The audio output level of the audio equipment is within the specification of the monitor. |

Problem

Check

- ⑧ A strange noise is heard. The Audio Cable is properly connected.
- ⑨ The touch screen shows no response. The USB Cable is firmly seated in the socket.
 Touch screen driver software is installed.
- ⑩ The touch position does not deviate. The calibration function set up correctly.

RECYCLING INFORMATION

For better environment protection please don't dispose your monitor.
Please visit our web site: www.iiyama.com for monitor recycling.

APPENDIX

Design and specifications are subject to change without prior notice.

SPECIFICATIONS : ProLite T2234MSC-B7X B

| | | |
|------------------------------|----------------------|--|
| Touch Screen | Technology | Projected capacitive 10pt touch |
| | Light transmission | 87% |
| | Hardness | 7H |
| | Thickness | 2.5mm |
| | Communication system | USB |
| | Surface finish | Anti fingerprint coating |
| Size Category | | 22" |
| LCD Panel | Panel technology | IPS |
| | Size | Diagonal: 21.5" (54.6cm) |
| | Pixel pitch | 0.247mm H × 0.247mm V |
| | Brightness | 350cd/m ² (Typical), 305cd/m ² (with Touch panel) |
| | Contrast ratio | 1000 : 1 (Typical: with Touch panel) |
| | Viewable angle | Horizontal : 178 °, Vertical: 178 ° (Typical) |
| | Response time | >8ms (Gray to Gray) |
| Display Colors | | Approx. 16.7M |
| Sync Frequency | | Horizontal: 30.0-84.0kHz, Vertical: 56-76Hz |
| Maximum Resolution | | 1920 × 1080, 2.1 MegaPixels |
| Input Connector | | VGA, HDMI, DisplayPort |
| Plug & Play | | VESA DDC2B™ |
| Input Sync Signal | | Separate sync: TTL, Positive or Negative |
| Input Video Signal | | Analog: 0.7Vp-p (Standard), 75Ω, Positive Digital: HDMI, DisplayPort |
| Input Audio Connector | | ø 3.5mm mini jack (Stereo) |
| Input Audio Signal | | 1.0Vrms maximum |
| Speakers | | 3W × 2 (Stereo speakers) |
| Maximum Screen Size | | 476.0mm W × 267.7mm H / 18.7" W × 10.5" H |
| Power Source | | 12VDC, 4A |
| AC Adapter (accessory) | | Input: 100-240VAC, 50-60Hz or 50/60Hz |
| Power Consumption*1 | | 21W typical Standby mode: 1.5W maximum, Off mode: 0.3W maximum |
| Dimensions / Net Weight | | 517.5 × 368.5 × 253.5mm / 20.4 × 14.5 × 10.0" (W×H×D) 5.8kg / 12.8lbs (Excluding the AC Adapter) |
| Tilt Angle | | Upward: 95 ° Downward: 25 ° |
| Environmental Considerations | | Operating: Temperature 0 to 40°C / 32 to 104°F Humidity 20 to 80% (No condensation) Storage: Temperature -20 to 60°C / -4 to 140°F Humidity 10 to 90% (No condensation) |
| Approvals | | CE, UKCA, cULus, VCCI, EAC, IP65*2 |

NOTE *1 When the USB devices are not connected.

*2 IP65 Standard Compliant : Only front face

DIMENSIONS

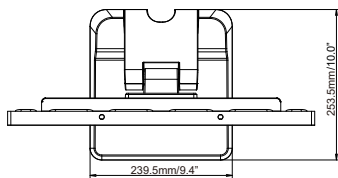
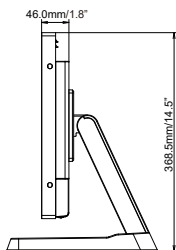
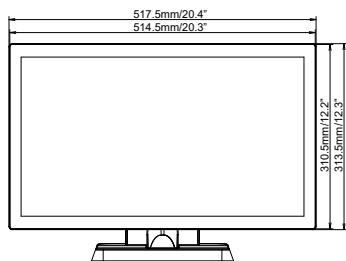

COMPLIANT TIMING

| Video Mode | Horizontal Frequency | Vertical Frequency | Dot Clock |
|-------------|----------------------|--------------------|------------|
| 640 × 480 | 31.469kHz | 59.940Hz | 25.175MHz |
| | 37.500kHz | 75.000Hz | 31.500MHz |
| | 37.861kHz | 72.809Hz | 31.500MHz |
| 800 × 600 | 35.156kHz | 56.250Hz | 36.000MHz |
| | 37.879kHz | 60.317Hz | 40.000MHz |
| | 46.875kHz | 75.000Hz | 49.500MHz |
| | 48.077kHz | 72.188Hz | 50.000MHz |
| 1024 × 768 | 48.363kHz | 60.004Hz | 65.000MHz |
| | 56.476kHz | 70.069Hz | 75.000MHz |
| | 60.023kHz | 75.029Hz | 78.750MHz |
| 1280 × 1024 | 63.981kHz | 60.020Hz | 108.000MHz |
| | 79.976kHz | 75.025Hz | 135.000MHz |
| 1440 × 900 | 55.935kHz | 59.887Hz | 106.500MHz |
| 1680 × 1050 | 65.290kHz | 59.954Hz | 146.250MHz |
| 1920 × 1080 | 67.500kHz | 60.000Hz | 148.500MHz |