

# HP Notebook User Guide

© Copyright 2011 Hewlett-Packard Development Company, L.P.

Bluetooth is a trademark owned by its proprietor and used by Hewlett-Packard Company under license. SD Logo is a trademark of its proprietor.

The information contained herein is subject to change without notice. The only warranties for HP products and services are set forth in the express warranty statements accompanying such products and services. Nothing herein should be construed as constituting an additional warranty. HP shall not be liable for technical or editorial errors or omissions contained herein.

First Edition: June 2011

Document Part Number: 654403-001

### **Product notice**

This guide describes features that are common to most models. Some features may not be available on your computer.

To obtain the latest information in this guide, go to the HP Web site at <http://www.hp.com/support>.

### **Software terms**

By installing, copying, downloading, or otherwise using any software product preinstalled on this computer, you agree to be bound by the terms of the HP End User License Agreement (EULA). If you do not accept these license terms, your sole remedy is to return the entire unused product (hardware and software) within 14 days for a refund subject to the refund policy of your place of purchase.

For any further information or for requesting a full refund of the computer, please contact your local point of sale (the seller).

## Safety warning notice

---

 **WARNING!** To reduce the possibility of heat-related injuries or of overheating the computer, do not place the computer directly on your lap or obstruct the computer air vents. Use the computer only on a hard, flat surface. Do not allow another hard surface, such as an adjoining optional printer, or a soft surface, such as pillows or rugs or clothing, to block airflow. Also, do not allow the AC adapter to come into contact with the skin or a soft surface, such as pillows or rugs or clothing, during operation. The computer and the AC adapter comply with the user-accessible surface temperature limits defined by the International Standard for Safety of Information Technology Equipment (IEC 60950).

---



---

# Table of contents

<b>1 Welcome</b> .....	<b>1</b>
Finding information .....	2
<b>2 Getting to know your computer</b> .....	<b>3</b>
Top .....	4
TouchPad .....	4
Lights .....	5
Buttons and fingerprint reader (select models only) .....	6
Keys .....	8
Front .....	9
Right .....	10
Left .....	11
Display .....	12
Rear .....	13
Bottom .....	13
<b>3 Networking</b> .....	<b>15</b>
Using an Internet service provider (ISP) .....	16
Identifying wireless and network status icons .....	16
Creating a wireless connection .....	16
Turning wireless devices on and off .....	16
Using the wireless button .....	16
Using the operating system controls .....	16
Using a WLAN .....	17
Connecting to an existing WLAN .....	17
Setting up a new WLAN .....	18
Protecting your WLAN .....	19
Roaming to another network .....	19
Using Bluetooth wireless devices (select models only) .....	20
Connecting to a wired network .....	20
Using a modem (select models only) .....	20

Connecting a modem cable .....	21
Connecting a country- or region-specific modem cable adapter .....	21
Connecting to a local area network (LAN) (select models only) .....	22

#### **4 Keyboard and pointing devices ..... 23**

Using the keyboard .....	23
Identifying the hotkeys .....	23
Using keypads .....	24
Using the embedded numeric keypad .....	24
Turning the embedded numeric keypad on and off .....	25
Switching key functions on the embedded numeric keypad .....	25
Using the TouchPad .....	26
Turning the TouchPad off and on .....	26
Navigating .....	26
Selecting .....	26
Using TouchPad gestures .....	27
Scrolling .....	28
Pinching/Zooming .....	28
Setting pointing device preferences .....	28
Using the fingerprint reader (select models only) .....	29
Locating the fingerprint reader .....	29
Enabling fingerprint authentication during logon .....	29
Enrolling your fingerprint .....	29

#### **5 Multimedia ..... 30**

Using the audio features .....	30
Adjusting the volume .....	31
Checking your audio functions .....	31
Using the Webcam (select models only) .....	32
Using video devices .....	32
VGA .....	32
DisplayPort .....	34

#### **6 Power management ..... 35**

Shutting down the computer .....	35
Setting power options .....	36
Using power-saving states .....	36
Initiating and exiting Suspend .....	36
Initiating and exiting Hibernation .....	37
Using the Power icon .....	37

Using power management .....	37
Viewing the current power management settings .....	37
Changing the current power management settings .....	37
Using battery power .....	38
Displaying the remaining battery charge .....	38
Inserting or removing the battery .....	39
Charging a battery .....	40
Maximizing battery life .....	41
Managing low battery levels .....	41
Identifying low battery levels .....	41
Resolving a low battery level .....	42
Resolving a low battery level when external power is available .....	42
Resolving a low battery level when a charged battery is available ...	42
Resolving a low battery level when no power source is available ...	42
Resolving a low battery level when the computer cannot exit	
Hibernation .....	42
Conserving battery power .....	42
Storing a battery .....	42
Disposing of a used battery .....	43
Replacing the battery .....	43
Using external AC power .....	43
Testing an AC adapter .....	44
<b>7 Drives .....</b>	<b>45</b>
Handling drives .....	45
Removing or replacing the bottom cover .....	46
Removing the bottom cover .....	46
Replacing the bottom cover .....	47
Replacing or upgrading the hard drive .....	49
Removing the hard drive .....	49
Installing a hard drive .....	49
Replacing a drive in the upgrade bay .....	50
Replacing a hard drive .....	50
Replacing an optical drive .....	53
Using optical drives (select models only) .....	55
Identifying the installed optical drive .....	55
Inserting an optical disc .....	55
Tray load .....	55
Slot load .....	56
Removing an optical disc .....	56
Tray load .....	56

When the disc tray opens normally .....	56
When the disc tray fails to open .....	57
Slot load .....	58
<b>8 External cards and devices .....</b>	<b>59</b>
Using Media Card Reader cards .....	59
Inserting a media card .....	59
Removing a media card .....	60
Using ExpressCards (select models only) .....	61
Configuring an ExpressCard .....	61
Inserting an ExpressCard .....	62
Removing an ExpressCard .....	63
Using a USB device .....	63
Connecting a USB storage device .....	64
Removing a USB device .....	64
Using 1394 devices .....	65
Connecting a 1394 device .....	65
Removing a 1394 device .....	65
Using an eSATA device .....	66
Connecting an eSATA device .....	66
Removing an eSATA device .....	66
Using optional external devices .....	67
Using optional external drives .....	67
Using the docking connector .....	68
<b>9 Memory modules .....</b>	<b>69</b>
<b>10 Security .....</b>	<b>72</b>
Protecting the computer .....	72
Using passwords .....	73
Setting passwords in the operating system .....	73
Setting passwords in Computer Setup .....	73
Managing an administrator password .....	74
Entering an administrator password .....	74
Managing a power-on password .....	74
Entering a power-on password .....	75
Using firewall software .....	75
Installing an optional security cable .....	76

<b>11 Backup and Recovery</b> .....	<b>77</b>
Performing a system recovery .....	78
Backing up your information .....	79
<b>12 Computer Setup (BIOS) and Advanced System Diagnostics</b> .....	<b>80</b>
Starting Computer Setup .....	80
Using Computer Setup .....	80
Navigating and selecting in Computer Setup .....	80
Restoring factory settings in Computer Setup .....	81
Updating the BIOS .....	82
Determining the BIOS version .....	82
Downloading a BIOS update .....	82
Using Advanced System Diagnostics .....	83
<b>13 MultiBoot</b> .....	<b>84</b>
About the boot device order .....	84
Enabling boot devices in Computer Setup .....	85
Considering boot order changes .....	86
Choosing MultiBoot preferences .....	87
Setting a new boot order in Computer Setup .....	87
Dynamically choosing a boot device using the f9 prompt .....	87
Setting a MultiBoot Express prompt .....	88
Entering MultiBoot Express preferences .....	88
<b>Appendix A Troubleshooting and support</b> .....	<b>89</b>
Troubleshooting .....	89
The computer is unable to start up .....	89
The computer screen is blank .....	89
Software is functioning abnormally .....	90
The computer is on but not responding .....	90
The computer is unusually warm .....	90
An external device is not working .....	90
The wireless network connection is not working .....	91
The optical disc tray does not open for removal of a CD or DVD .....	91
The computer does not detect the optical drive .....	92
A disc does not play .....	92
A movie is not visible on an external display .....	92
The process of burning a disc does not begin, or it stops before completion .....	93
Contacting customer support .....	93
Labels .....	94

<b>Appendix B Cleaning your computer .....</b>	<b>95</b>
Cleaning products .....	95
<b>Appendix C Specifications .....</b>	<b>96</b>
Input power .....	97
Operating environment .....	98
<b>Appendix D Electrostatic discharge .....</b>	<b>99</b>
<b>Index .....</b>	<b>100</b>

---

# 1 Welcome

The following sections are included in this chapter:

- [Finding information](#)

After you set up and register the computer, take the following steps:

- **Connect to the Internet**—Set up your wired or wireless network so that you can connect to the Internet. For more information, refer to [Networking on page 15](#).
- **Get to know your computer**—Learn about your computer features. Refer to [Getting to know your computer on page 3](#) and [Keyboard and pointing devices on page 23](#) for additional information.
- **Find installed software**—Access a list of the software preinstalled on the computer. Select **Computer > More Applications**. The list of preinstalled software is displayed.



---

**NOTE:** For details about using the software included with the computer, select **Computer > Help**. You can also refer to the software manufacturer's instructions, which may be provided with the software or on the manufacturer's Web site.

---

- **Update programs and drivers**—Update your programs and drivers with the latest versions on a regular basis. When your computer is registered, it will automatically be updated with the latest versions. When you register, you can choose to receive automatic notifications when updates become available. The automatic notifications for operating system updates are available for 90 days. You can also go to <http://www.hp.com/support> to download updates from HP.

# Finding information

The computer comes with several resources to help you perform various tasks.

Resources	For information about
<i>Setup Instructions</i> poster	<ul style="list-style-type: none"><li>• Setting up the computer</li><li>• Identifying computer components</li></ul>
Linux Help To access the Linux Help, select <b>Computer &gt; Help</b> .	<ul style="list-style-type: none"><li>• Computer software</li><li>• Computer settings</li><li>• Connecting to the Internet</li><li>• Computer utilities</li></ul>
<i>Regulatory, Safety, and Environmental Notices</i> To access the notices, click the <b>HP Documents</b> icon located on the desktop.	<ul style="list-style-type: none"><li>• Regulatory and safety information</li><li>• Battery disposal information</li></ul>
<i>Safety &amp; Comfort Guide</i> To access this guide, click the <b>HP Documents</b> icon located on the desktop.	<ul style="list-style-type: none"><li>• Proper workstation setup, posture, health, and work habits</li><li>• Electrical and mechanical safety information</li></ul>
– or – Go to <a href="http://www.hp.com/ergo">http://www.hp.com/ergo</a> .	
<i>Worldwide Telephone Numbers</i> booklet This booklet is provided with your computer.	HP support telephone numbers
HP Web site To access this Web site, go to <a href="http://www.hp.com/support">http://www.hp.com/support</a> .	<ul style="list-style-type: none"><li>• Support information</li><li>• Ordering parts and finding additional help</li><li>• Software, driver, and BIOS updates</li><li>• Accessories available for the device</li></ul>
<i>Limited Warranty*</i> To access the warranty: Double-click the <b>HP Documents</b> icon located on the desktop.	Warranty information
– or – Go to <a href="http://www.hp.com/go/orderdocuments">http://www.hp.com/go/orderdocuments</a> .	
<p>*You can find the expressly provided HP Limited Warranty applicable to your product located with the user guides on your computer and/or on the CD/DVD provided in the box. In some countries/regions, HP may provide a printed HP Limited Warranty in the box. For some countries/regions where the warranty is not provided in printed format, you may request a printed copy from <a href="http://www.hp.com/go/orderdocuments">http://www.hp.com/go/orderdocuments</a> or write to:</p> <ul style="list-style-type: none"><li>• <b>North America:</b> Hewlett-Packard, MS POD, 11311 Chinden Blvd, Boise, ID 83714, USA</li><li>• <b>Europe, Middle East, Africa:</b> Hewlett-Packard, POD, Via G. Di Vittorio, 9, 20063, Cernusco s/Naviglio (MI), Italy</li><li>• <b>Asia Pacific:</b> Hewlett-Packard, POD, P.O. Box 200, Alexandra Post Office, Singapore 911507</li></ul> <p>Please include your product number, warranty period (found on your serial number label), name and postal address.</p>	

---

## 2 Getting to know your computer

The following sections are included in this chapter:

- [Top](#)
- [Front](#)
- [Right](#)
- [Left](#)
- [Display](#)
- [Rear](#)
- [Bottom](#)

# Top

## TouchPad



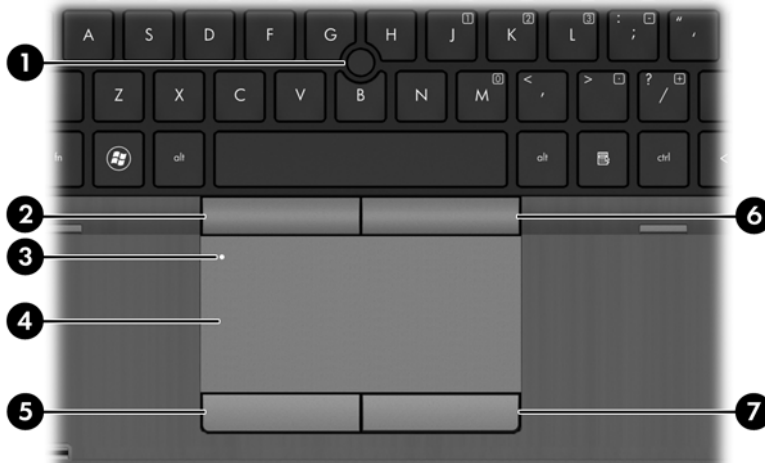

 **NOTE:** Your computer may look slightly different from the illustration in this section.



Component	Description
(1)	Pointing stick (select models only) Moves the pointer and selects or activates items on the screen.
(2)	Left pointing stick button (select models only) Functions like the left button on an external mouse.
(3)	TouchPad on/off button Turns the TouchPad on and off.
(4)	TouchPad Moves the pointer and selects or activates items on the screen. <b>NOTE:</b> Vertical scrolling is supported on the right edge of the TouchPad.
(5)	Left TouchPad button Functions like the left button on an external mouse.
(6)	Right pointing stick button (select models only) Functions like the right button on an external mouse.
(7)	Right TouchPad button Functions like the right button on an external mouse.



## Lights



Component	Description
(1) TouchPad light	<ul style="list-style-type: none"> <li>Amber: The TouchPad is off.</li> <li>Off: The TouchPad is on.</li> </ul>
(2) Caps lock light	On: Caps lock is on.
(3)  Power light	<ul style="list-style-type: none"> <li>On: The computer is on.</li> <li>Blinking: The computer is in the Suspend state.</li> <li>Off: The computer is off or in Hibernation.</li> </ul>
(4)  Wireless light	<ul style="list-style-type: none"> <li>White: An integrated wireless device, such as a wireless local-area network (WLAN) device and/or a Bluetooth® device, is on.</li> <li>Amber: All wireless devices are off.</li> </ul>
(5)  QuickWeb light	<ul style="list-style-type: none"> <li>On: The computer is on.</li> <li>Blinking: The Web browser is loading.</li> <li>Off: The computer is off, in the Suspend state, or in Hibernation.</li> </ul>
(6)  Mute light	<ul style="list-style-type: none"> <li>Amber: Computer sound is off.</li> <li>Off: Computer sound is on.</li> </ul>
(7) Num lock light	On: Num lock is on.

## Buttons and fingerprint reader (select models only)



Component	Description
(1)	TouchPad on/off button
(2) 	<p>Power button</p> <ul style="list-style-type: none"> <li>When the computer is off, press the button to turn on the computer.</li> <li>When the computer is on, press the button briefly to initiate Suspend.</li> <li>When the computer is in the Suspend state, press the button briefly to exit Suspend.</li> <li>When the computer is in Hibernation, press the button briefly to exit Hibernation.</li> </ul> <p>If the computer has stopped responding and operating system shutdown procedures are ineffective, press and hold the power button for at least 5 seconds to turn off the computer.</p> <p>To learn more about your power settings:</p> <ol style="list-style-type: none"> <li>Select <b>Computer &gt; Control Center</b>.</li> <li>In the left pane, click <b>System</b>, and then click <b>Power Management</b> in the right pane.</li> </ol>
(3) 	<p>Wireless button</p> <p>Turns the wireless feature on or off and establishes a connection if a wireless connection has already been configured.</p>
(4) 	<p>QuickWeb button</p> <ul style="list-style-type: none"> <li>When the computer is on, press the button to open the default Web browser.</li> </ul> <p><b>NOTE:</b> Pressing the QuickWeb button a second time opens a second browser window. <ul style="list-style-type: none"> <li>When the computer is off, in the Suspend state, or in Hibernation, the button does not perform any action or function.</li> </ul> </p>

Component		Description
(5)	 Volume mute button	Mutes and restores speaker sound.
(6)	Fingerprint reader (select models only)	Allows a fingerprint logon to the operating system, instead of a password logon.

## Keys

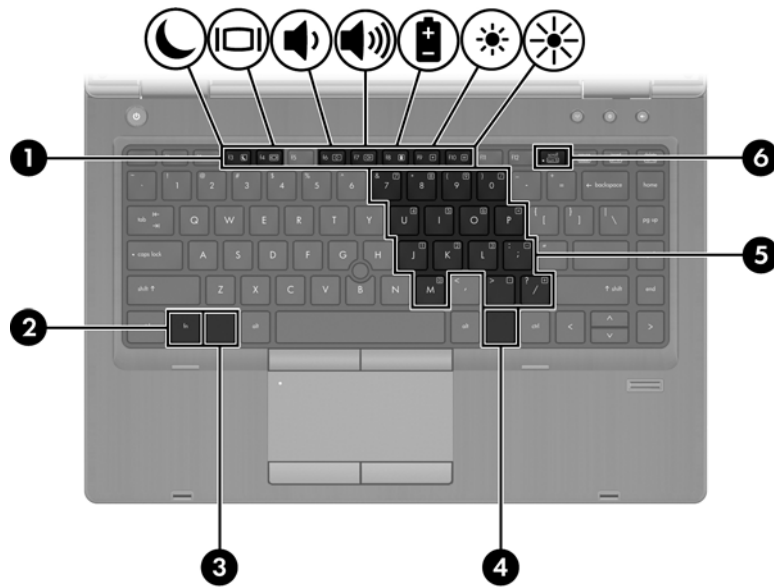

Component	Description
(1) Function keys	Execute frequently used system functions when pressed in combination with the <b>fn</b> key.
(2) <b>fn</b> key	Executes frequently used system functions when pressed in combination with a function key.
(3) Operating system logo key	Displays the operating system menu.
(4) Operating system applications key	Displays a shortcut menu for items beneath the cursor.
(5) Embedded numeric keypad	When the keypad has been enabled, the keys can be used like an external numeric keypad.
(6) <b>num lk</b> key	Turns the embedded numeric keypad on and off when pressed in combination with the <b>fn</b> key.



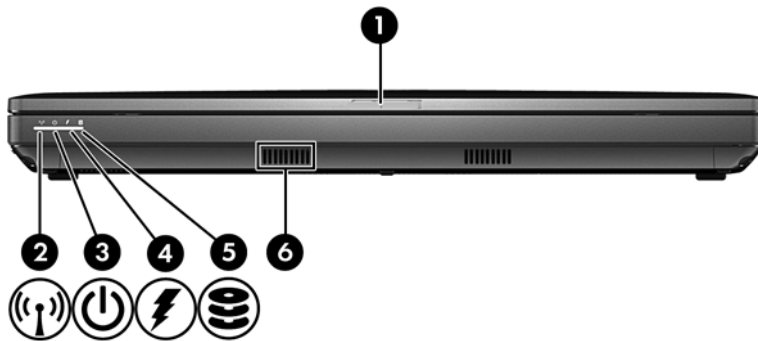



# Front

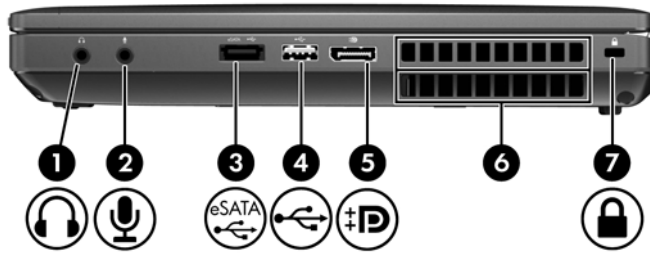

Component	Description
(1) Display release latch	Opens the computer.
(2) Wireless light	<ul style="list-style-type: none"> <li>White: An integrated wireless device, such as a wireless local area network (WLAN) device and/or a Bluetooth® device, is on.</li> <li>Amber: All wireless devices are off.</li> </ul>
(3) Power light	<ul style="list-style-type: none"> <li>On: The computer is on.</li> <li>Blinking: The computer is in the Suspend state.</li> <li>Off: The computer is off or in Hibernation.</li> </ul>
(4) Battery light	<ul style="list-style-type: none"> <li>Amber: The computer is connected to external power and the battery is charged from 0 to 90%.</li> <li>White: The computer is connected to external power and the battery is charged from 90 to 99%.</li> <li>Blinking amber: A battery that is the only available power source has reached a low battery level. When the battery reaches a critical battery level, the battery light begins blinking rapidly.</li> <li>Off: The battery is fully charged.</li> </ul>
(5) Hard drive light	<ul style="list-style-type: none"> <li>Blinking white: The hard drive or optical drive is being accessed.</li> <li>Amber: HP 3D DriveGuard has temporarily parked the hard drive.</li> </ul>
(6) Speaker	Produces sound.





# Right

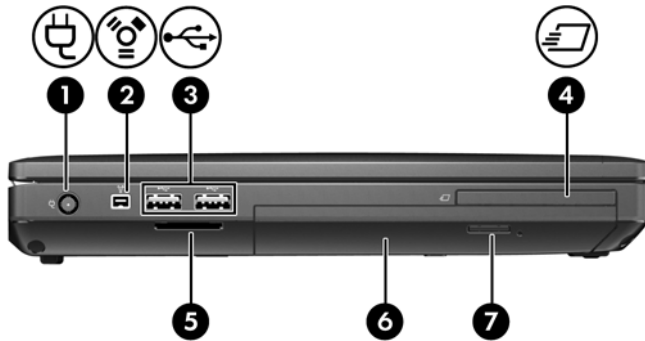

Component	Description
(1)  Audio-out (headphone) jack	Connects optional powered stereo speakers, headphones, earbuds, a headset, or television audio.  <b>WARNING!</b> To reduce the risk of personal injury, adjust the volume before putting on headphones, earbuds, or a headset. For additional safety information, refer to the <i>Regulatory, Safety, and Environmental Notices</i> .  <b>NOTE:</b> When a device is connected to the headphone jack, the computer speakers are disabled.
(2)  Audio-in (microphone) jack	Connects an optional computer headset microphone, stereo array microphone, or monaural microphone.
(3)  eSATA/USB 2.0 combo port	Connects a high-performance eSATA component, such as an eSATA external hard drive, or connects an optional USB device.
(4)  USB 2.0 port	Connects an optional USB device.
(5)  DisplayPort	Connects an optional digital display device, such as a high-performance monitor or projector.
(6) Vents (2)	Enable airflow to cool internal components.  <b>NOTE:</b> The computer fan starts up automatically to cool internal components and prevent overheating. It is normal for the internal fan to cycle on and off during routine operation.
(7)  Security cable slot	Attaches an optional security cable to the computer.  <b>NOTE:</b> The security cable is designed to act as a deterrent, but it may not prevent the computer from being mishandled or stolen.

# Left



Component	Description
(1)  Power connector	Connects an AC adapter.
(2)  1394 port	Connects an optional IEEE 1394 or 1394a device, such as a camcorder.
(3)  USB 2.0 ports (2)	Connect optional USB devices.
(4)  ExpressCard slot or smart card reader (depending on configuration)	Supports optional ExpressCards or smart cards.
(5) Media Card Reader	Supports the following digital card formats: <ul style="list-style-type: none"> <li>• MultiMediaCard</li> <li>• Secure Digital (SD) Memory Card</li> </ul>
(6) Upgrade bay (optical drive shown)	The upgrade bay can hold either a hard drive or an optical drive that reads and writes (select models only) to an optical disc. It can also hold a weight saver option.
(7) Optical drive eject button (select models only)	Ejects the optical drive disc tray.

# Display

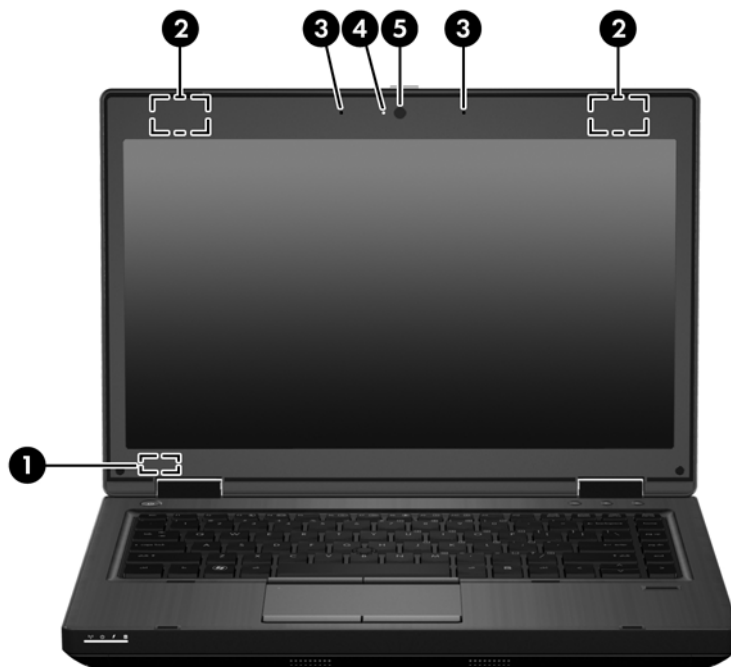



Component	Description
(1) Internal display switch	Turns off the display or initiates Suspend if the display is closed while the power is on.  <b>NOTE:</b> The display switch is not visible from the outside of the computer.
(2) WLAN antennas (2)*	Send and receive wireless signals to communicate with wireless local area networks (WLAN).
(3) Internal microphone(s) (1 or 2 depending on model)	Record sound.
(4) Webcam light (select models only)	On: The webcam is in use.
(5) Webcam (select models only)	Records video and captures still photographs.

\*The antennas are not visible from the outside of the computer. For optimal transmission, keep the areas immediately around the antennas free from obstructions. To see wireless regulatory notices, refer to the section of the *Regulatory, Safety and Environmental Notices* that applies to your country or region.

## Rear



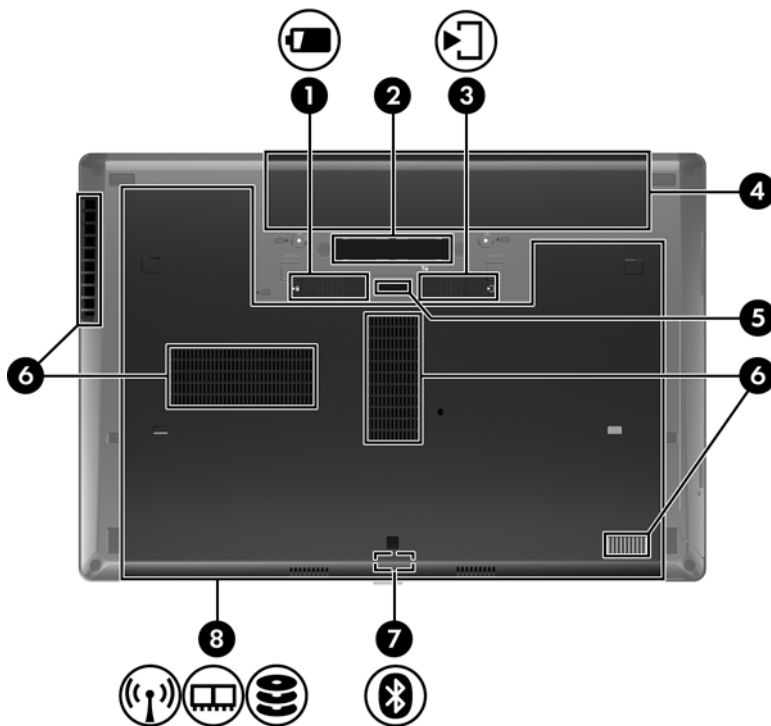

Component	Description
(1) 	RJ-11 (modem) jack Connects a modem cable.
(2) 	External monitor port Connects an external VGA monitor or projector.
(3) 	RJ-45 (network) jack Connects a network cable.

## Bottom



Component	Description
(1) 	Battery release latch Releases the battery from the battery bay.
(2)	Docking connector Connects an optional docking device.

Component	Description
(3)  Bottom cover release latch	Releases or locks the bottom cover.
(4) Battery bay	Holds the battery.
(5) Accessory battery connector	Connects an optional accessory battery.
(6) Vents (4)	Enable airflow to cool internal components.  <b>NOTE:</b> The computer fan starts up automatically to cool internal components and prevent overheating. It is normal for the internal fan to cycle on and off during routine operation.
(7)  Bluetooth compartment	Contains a Bluetooth device.
(8)  Wireless and memory module compartments and hard drive bay	Holds the hard drive, the wireless LAN module slot, and the memory module slots.  <b>CAUTION:</b> To prevent an unresponsive system, replace the wireless module only with a wireless module authorized for use in the computer by the governmental agency that regulates wireless devices in your country or region. If you replace the module and then receive a warning message, remove the module to restore computer functionality, and then contact technical support.

---

# 3 Networking

The following sections are included in this chapter:

- [Using an Internet service provider \(ISP\)](#)
- [Identifying wireless and network status icons](#)
- [Creating a wireless connection](#)
- [Using a WLAN](#)
- [Using Bluetooth wireless devices \(select models only\)](#)
- [Connecting to a wired network](#)

Your computer may support one or both of the following types of Internet access:

- **Wireless**—For mobile Internet access, you can use a wireless connection. Refer to [Connecting to an existing WLAN on page 17](#) or [Setting up a new WLAN on page 18](#).
- **Wired**—You can access the Internet by connecting to a wired network. For information on connecting to a wired network, refer to [Connecting to a wired network on page 20](#).



**NOTE:** Internet hardware and software features vary depending on computer model and your location.



---

## Using an Internet service provider (ISP)

Before you can connect to the Internet, you must establish an ISP account. Contact a local ISP to purchase Internet service and a modem. The ISP can help set up the modem, install a network cable to connect your wireless computer to the modem, and test the Internet service.

 **NOTE:** Your ISP will give you a user ID and password to access the Internet. Record this information and store it in a safe place.

## Identifying wireless and network status icons

Icon	Name	Description
	Wireless (connected)	Indicates that one or more wireless devices are on.
	Network Connection (connected)	Indicates that the wired network is connected and active. If both wired and wireless connections are active, the operating system uses the wired connection because it is faster.
	Network Connection (disconnected)	Indicates that wired and wireless networks are not connected.

## Creating a wireless connection

Your computer may be equipped with one or more of the following wireless devices:

- Wireless local-area network (WLAN) device
- Bluetooth® device

## Turning wireless devices on and off

### Using the wireless button

Use the wireless button to turn both the wireless network controller and the Bluetooth controller off or on simultaneously. They can be controlled individually through Control Center or Computer Setup.

 **NOTE:** Refer to [Getting to know your computer on page 3](#) for information on identifying the location of the wireless button on your computer.

### Using the operating system controls

To enable or disable a wireless or wired network device:

1. Right-click the **Network Connection** icon in the notification area, at the far right of the taskbar.
2. To enable or disable one of the following devices, select or clear one of the following options:
  - **Enable Networking** (all network devices)
  - **Enable Wireless**

# Using a WLAN

A wireless connection connects the computer to Wi-Fi networks, or WLANs. A WLAN is composed of other computers and accessories that are linked by a wireless router or a wireless access point.

 **NOTE:** When creating a wireless connection or allowing access to users in a network, you are prompted for the root password.

---

## Connecting to an existing WLAN

1. Be sure that the WLAN device is on.

 **NOTE:** Refer to [Getting to know your computer on page 3](#) for information on identifying the location of the wireless button and wireless light on your computer.

---

2. Click the **Network Connection** icon in the notification area, at the far right of the taskbar.

Available wireless networks are listed under **Wireless Networks**.

3. Click the desired wireless network.

If the network is a security-enabled WLAN, you are prompted to enter a network security code. Type the code, and then click **OK** to complete the connection.

 **NOTE:** To connect to a network that is not automatically detected, click the **Network Connection** icon and select **Connect to Hidden Wireless Network**. Enter the ESSID information, and set encryption parameters.

---

 **NOTE:** If no WLANs are listed, and your network is not hidden, you are out of range of a wireless router or access point. If you are within range of an access point or wireless router, verify that the wireless card is active by pressing the wireless button.

---

If you do not see the network you want to connect to, right-click the **Network Connection** icon in the notification area, at the far right of the taskbar, and click **Edit Connections**.

## Setting up a new WLAN

Required equipment:

- A broadband modem (either DSL or cable) **(1)** and high-speed Internet service purchased from an Internet service provider (ISP)
- A wireless router (purchased separately) **(2)**
- The wireless computer **(3)**

The illustration below shows an example of a wireless network installation that is connected to the Internet.



---

 **NOTE:** Some cable modems include a built-in router. Check with your ISP to see if you need a separate router.

 **NOTE:** When setting up a wireless connection, be sure that your computer and wireless router are synchronized. To synchronize your computer and wireless router, turn your computer and wireless router off and then back on.

---

As your network grows, additional wireless and wired computers can be connected to the network to access the Internet.

For help in setting up your WLAN, refer to the information provided by your router manufacturer or your ISP.

## Protecting your WLAN

When you set up a WLAN or access an existing WLAN, always enable security features to protect your network from unauthorized access. WLANs in public areas (hotspots) like coffee shops and airports may not provide any security. If you are concerned about the security of your computer in a hotspot, limit your network activities to e-mail that is not confidential and basic Internet surfing.

Wireless radio signals travel outside the network, so other WLAN devices can pick up unprotected signals. You can use the following precautions to protect your WLAN:

- **Use a Firewall**—Checks both data and requests for data that are sent to your network, and discards any suspicious items. Firewalls are available in both software and hardware. Some networks use a combination of both types.
- **Encrypt your data**—Wi-Fi Protected Access (WPA and WPA2) encrypts and decrypts data transmitted over the network. WPA uses Advanced Encryption Standard (AES) and Temporal Key Integrity Protocol (TKIP) to dynamically generate a new key for every packet. It also generates different sets of keys for each computer on the network. Wired Equivalent Privacy (WEP) encrypts data before it is transmitted using a WEP key. Without the correct key, others will not be able to use the WLAN.

## Roaming to another network

When you move your computer within range of another WLAN, the operating system attempts to connect to that network. If the attempt is successful, your computer is automatically connected to the new network. If the operating system does not recognize the new network, follow the same procedure you used initially to connect to your WLAN.

## Using Bluetooth wireless devices (select models only)

A Bluetooth device provides short-range wireless communications that replace the physical cable connections that traditionally link electronic devices such as the following:

- Computers
- Phones
- Audio devices

The strength of Bluetooth is in synchronizing information transfers between your computer and wireless devices. The inability to consistently connect two or more computers to share the Internet through Bluetooth is a limitation of Bluetooth and the operating system.

Bluetooth devices provide peer-to-peer capability that allows you to set up a personal area network (PAN) of Bluetooth devices. For information on configuring and using Bluetooth devices, refer to the Bluetooth software Help.

## Connecting to a wired network

### Using a modem (select models only)

A modem must be connected to an analog telephone line using a 6-pin, RJ-11 modem cable (purchased separately). In some countries or regions, a specific modem cable adapter is also required. Jacks for digital PBX systems may resemble analog telephone jacks, but they are not compatible with the modem.

---

**⚠ WARNING!** To reduce the risk of electric shock, fire, or damage to the equipment, do not plug a modem or telephone cable into the RJ-45 (network) jack.

---

If the modem cable contains noise suppression circuitry **(1)**, which prevents interference from TV and radio reception, orient the circuitry end of the cable **(2)** toward the computer.



## Connecting a modem cable

1. Plug the modem cable into the modem jack (1) on the computer.
2. Plug the modem cable into the RJ-11 telephone wall jack (2).

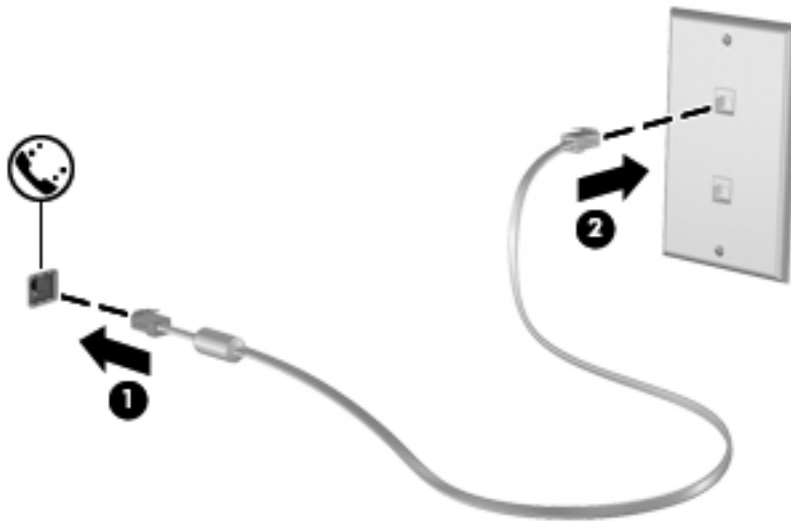

## Connecting a country- or region-specific modem cable adapter

Telephone jacks vary by country or region. To use the modem and the modem cable outside the country or region in which you purchased the computer, you must obtain a country- or region-specific modem cable adapter.

To connect the modem to an analog telephone line that does not have an RJ-11 telephone jack, follow these steps:

1. Plug the modem cable into the modem jack (1) on the computer.
2. Plug the modem cable into the modem cable adapter (2).
3. Plug the modem cable adapter (3) into the telephone wall jack.

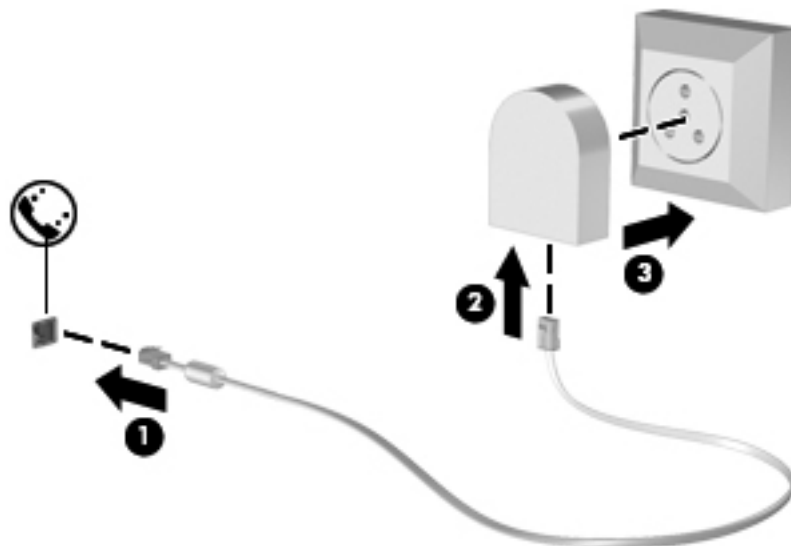

## Connecting to a local area network (LAN) (select models only)

Connecting to a local area network (LAN) requires an 8-pin, RJ-45 network cable (purchased separately). If the network cable contains noise suppression circuitry (1), which prevents interference from TV and radio reception, orient the circuitry end of the cable (2) toward the computer.



To connect the network cable:

1. Plug the network cable into the network jack (1) on the computer.
2. Plug the other end of the cable into a network wall jack (2).

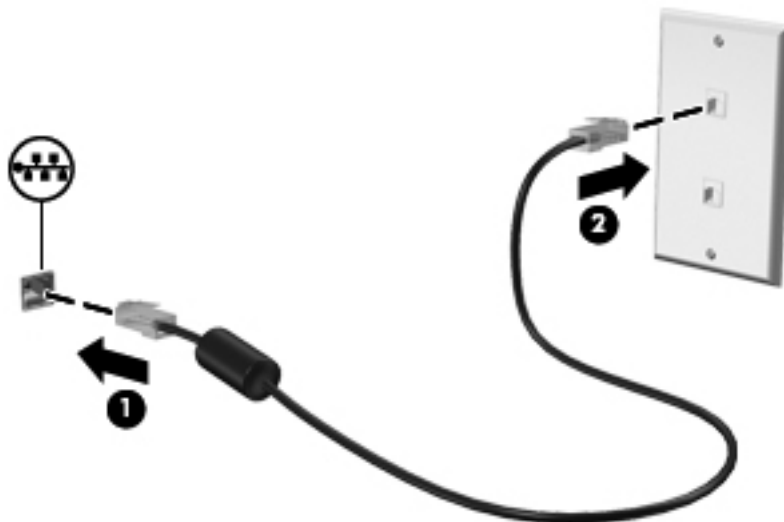

**⚠ WARNING!** To reduce the risk of electric shock, fire, or damage to the equipment, do not plug a modem or telephone cable into the RJ-45 (network) jack.

# 4 Keyboard and pointing devices

The following sections are included in this chapter:

- [Using the keyboard](#)
- [Using the TouchPad](#)
- [Using the fingerprint reader \(select models only\)](#)

## Using the keyboard





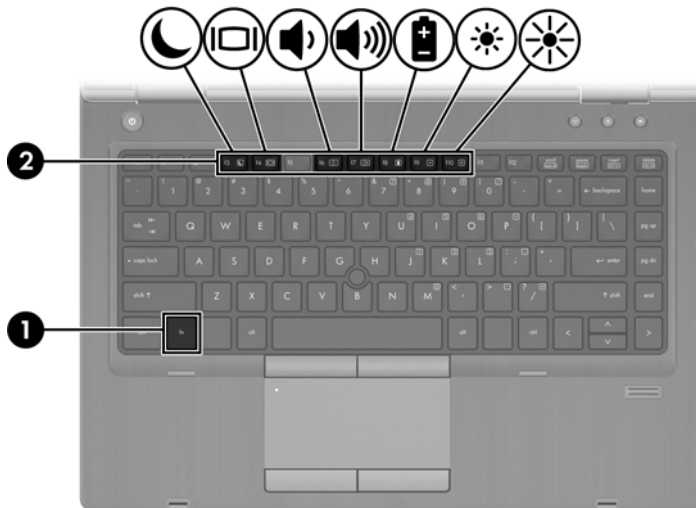

### Identifying the hotkeys

A hotkey is a combination of the **fn** key **(1)** and one of the function keys **(2)**.



To use a hotkey:

- ▲ Briefly press the **fn** key, and then briefly press the second key of the hotkey combination.

Hotkey combination	Description
 <b>fn+f3</b>	<p>Initiates Suspend, which saves your information in system memory. The display and other system components turn off and power is conserved.</p> <p>To exit Suspend, briefly press the power button.</p> <p><b>CAUTION:</b> To reduce the risk of information loss, save your work before initiating Suspend.</p> <p><b>NOTE:</b> If a critical battery level occurs while the computer is in Suspend, the computer initiates Hibernation and the information stored in system memory is saved to the hard drive.</p>
 <b>fn+f4</b>	<p>Switches the screen image among display devices connected to the system. For example, if a monitor is connected to the computer, <b>fn+f4</b> alternates the screen image from computer display to monitor display to simultaneous display on both the computer and the monitor.</p> <p>Most external monitors receive video information from the computer using the external VGA video standard. The <b>fn+f4</b> hotkey can also alternate images among other devices that are receiving video information from the computer.</p>
 <b>fn+f6</b>	Decreases speaker volume.
 <b>fn+f7</b>	Increases speaker volume.
 <b>fn+f8</b>	Displays charge information for all installed batteries. The display indicates which batteries are charging and reports the amount of charge remaining in each battery.
 <b>fn+f9</b>	Decreases the screen brightness level.
 <b>fn+f10</b>	Increases the screen brightness level.

## Using keypads

The computer includes an embedded numeric keypad. The computer also supports an optional external numeric keypad or an optional external keyboard that includes a numeric keypad.

### Using the embedded numeric keypad

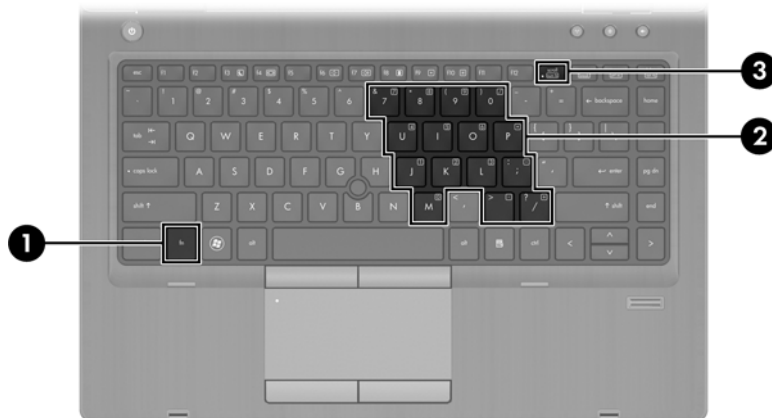

Component	Description
(1) <b>fn</b> key	<p>Turns the embedded numeric keypad on and off when pressed in combination with the <b>num lk</b> key.</p> <p><b>NOTE:</b> The embedded numeric keypad will not function while an external keyboard or numeric keypad is connected to the computer.</p>
(2) Embedded numeric keypad	<p>When the keypad is turned on, it can be used like an external numeric keypad.</p> <p>Each key on the keypad performs the function indicated by the icon in the upper-right corner of the key.</p>
(3) <b>num lk</b> key	<p>Turns the embedded numeric keypad on and off when pressed in combination with the <b>fn</b> key.</p> <p><b>NOTE:</b> The keypad function that is active when the computer is turned off is reinstated when the computer is turned back on.</p>

### Turning the embedded numeric keypad on and off

Press **fn+num lk** to turn on the embedded numeric keypad. Press **fn+num lk** again to turn off the keypad.



**NOTE:** The embedded numeric keypad is turned off while an external keyboard or numeric keypad is connected to the computer.

### Switching key functions on the embedded numeric keypad

You can temporarily alternate the functions of keys on the embedded numeric keypad between their standard keyboard functions and their keypad functions:

- To use the navigational function of a keypad key while the keypad is off, press and hold the **fn** key while pressing the keypad key.
- To use the standard function of a keypad key while the keypad is on:
  - Press and hold the **fn** key to type in lowercase.
  - Press and hold **fn+shift** to type in uppercase.

## Using the TouchPad

To move the pointer, slide one finger across the TouchPad in the direction you want the pointer to go. Use the left and right TouchPad buttons like the buttons on an external mouse.

 **NOTE:** In addition to the pointing devices included with your computer, you can use an external USB mouse (purchased separately) by connecting it to one of the USB ports on the computer.

## Turning the TouchPad off and on

To turn the TouchPad off and on, quickly double-tap the TouchPad on/off button.

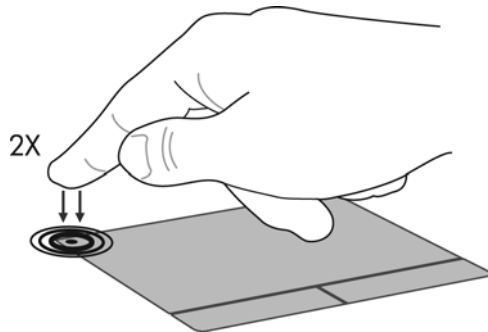

## Navigating

To move the pointer, slide one finger across the TouchPad in the direction you want the pointer to go.

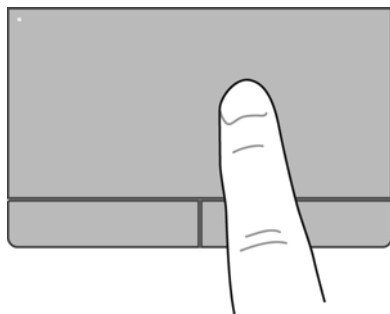

## Selecting

Use the left and right TouchPad buttons like the corresponding buttons on an external mouse.

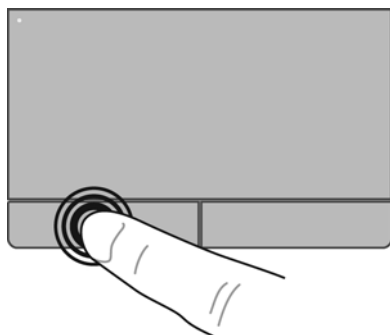

## Using TouchPad gestures

The TouchPad supports a variety of gestures. To use TouchPad gestures, place two fingers on the TouchPad at the same time.

---

 **NOTE:** TouchPad gestures are not supported in all programs.

---

To view information about each gesture:

1. Select **Computer > More Applications**.
2. In the left pane, click **System**, and then click the **TouchPad** icon  in the right pane.
3. On the **Device Settings** tab, select the device in the window that is displayed, and then click **Settings**.
4. Select the gesture to view information about its features.

To turn the gestures on and off:

1. Select **Computer > More Applications**.
2. In the left pane, click **System**, and then click the **TouchPad** icon  in the right pane.
3. On the **Device Settings** tab, select the device in the window that is displayed, and then click **Settings**.
4. Select the check box next to the gesture that you want to turn on or off.
5. Click **Apply**, and then click **OK**.

## Scrolling

Scrolling is useful for moving up, down, or sideways on a page or image. To scroll, place two fingers slightly apart on the TouchPad, and then drag them across the TouchPad in an up, down, left, or right motion.

 **NOTE:** Scrolling speed is controlled by finger speed.

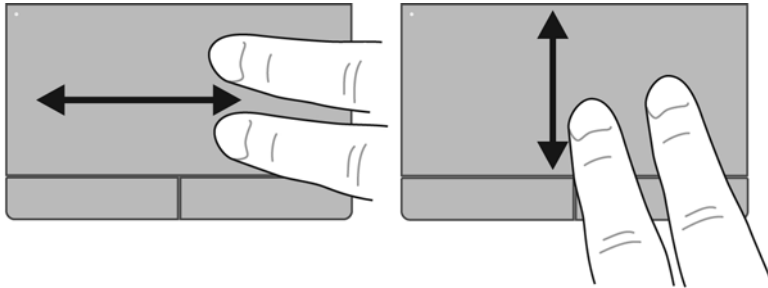

## Pinching/Zooming

Pinching allows you to zoom in or out on images or text.

- Zoom in by placing two fingers together on the TouchPad, and then moving them apart.
- Zoom out by placing two fingers apart on the TouchPad, and then moving them together.

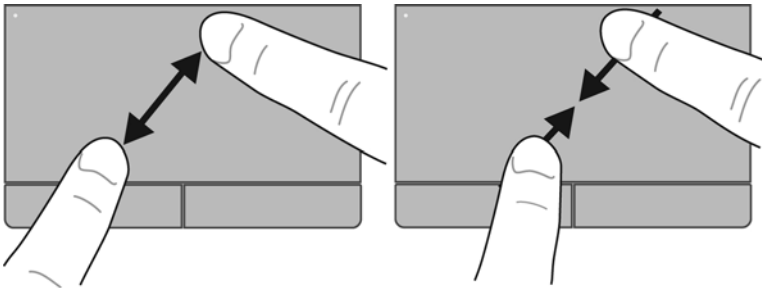

## Setting pointing device preferences

To customize settings for pointing devices, such as button configuration, click speed, and pointer options:

1. Select **Computer > Control Center**.
2. In the left pane, click **Hardware**, and then click **Mouse** in the right pane.

## Using the fingerprint reader (select models only)

Integrated fingerprint readers are available on select computer models. In order to use the fingerprint reader, you must set up a user account with a password on the computer. This account allows you to log on to your computer with a swipe of a designated finger.

### Locating the fingerprint reader

The fingerprint reader is a small metallic sensor that is located to the right of the TouchPad.

### Enabling fingerprint authentication during logon

To enable fingerprint authentication during logon:

1. Select **Computer > YaST**.
2. Enter your root password, and then click **Continue**.
3. In the left pane, click **Hardware**, and then click **Fingerprint Reader** in the right pane.
4. Select the **Use Fingerprint Reader** option.

---

 **NOTE:** To enroll your fingerprint, you must open the user management utility. You can start this utility from the account setup dialog box by selecting the check box next to **Start user management after finish**.

---

### Enrolling your fingerprint

If you did not enroll your fingerprint when you set up your fingerprint user account, you can open the user management utility to modify your fingerprint settings. To open the user management utility and enroll your fingerprint:

1. Select **Computer > YaST**.
2. Enter your root password, and then click **Continue**.
3. In the left pane, click **Security and Users**, and then click **User and Group Management** in the right pane.
4. Select the account that you want to modify, and then click **Edit**.
5. Click the **Plug-Ins** tab, click **Set the user's fingerprint**, and then click **Launch**.
6. Follow the on-screen instructions to enroll your fingerprint.

---

 **NOTE:** After your fingerprint is enrolled, you can swipe your finger on the fingerprint reader when you turn on the computer, unlock the computer, or resume from the Suspend or Hibernation state, instead of typing a password.

---

---

# 5 Multimedia

The following sections are included in this chapter:

- [Using the audio features](#)
- [Using the Webcam \(select models only\)](#)
- [Using video devices](#)

Your computer may include the following:

- Integrated speakers
- Integrated microphones
- Integrated webcam
- Preinstalled multimedia software
- Multimedia buttons or keys

## Using the audio features

Your computer enables you to use a variety of audio features:

- Play music.
- Record sound.
- Download music from the Internet.
- Create multimedia presentations.
- Transmit sound and images with instant messaging programs.
- Stream radio programs.
- Create (burn) audio CDs using the installed optical drive (select models only) or on an optional external optical drive (purchased separately).

## Adjusting the volume

Depending on your computer model, you can adjust the volume using the following:

- Volume buttons
- Volume hotkeys
- Volume keys

---

 **WARNING!** To reduce the risk of personal injury, adjust the volume before putting on headphones, earbuds, or a headset. For additional safety information, refer to the *Regulatory, Safety and Environmental Notices*.

 **NOTE:** Volume can also be controlled through the operating system and some programs.

 **NOTE:** Refer to [Getting to know your computer on page 3](#) and [Keyboard and pointing devices on page 23](#) for information on what type of volume controls your computer has.

---

## Checking your audio functions

To check the system sound on your computer, follow these steps:

1. Select **Computer > Control Center**.
2. In the left pane, click **Hardware**, and then click **Sound** in the right pane.
3. Click the **Sound Effects** tab, and then select one of the sound options under **Choose an alert sound** to test each sound.

To check the recording functions of the computer, follow these steps:

1. Select **Computer > Control Center**.
2. In the left pane, click **Hardware**, and then click **Sound** in the right pane.
3. Click the **Input** tab, and then select **Microphone** or **Line-in** in the drop-down menu next to **Connector**.
4. Adjust the input volume by moving the **Input volume** slider to the desired setting.

---

 **NOTE:** For best results when recording, speak directly into the microphone and record sound in a setting free of background noise.

---

To confirm or change the audio settings on your computer, right-click the **Sound** icon in the notification area, at the far right of the taskbar.

## Using the Webcam (select models only)

Some computers include an integrated webcam, located at the top of the display. With the preinstalled software, Cheese, you can use the webcam to take a photo or record a video. You can preview and save the photo or video recording.

The webcam software enables you to experiment with the following features:

- Capturing and sharing video
- Streaming video with instant message software
- Taking still photos

---

 **NOTE:** For details about using your webcam, click the Help menu in the Cheese software.

---

## Using video devices

Your computer may have one or more of the following external video ports:

- VGA
- DisplayPort

### VGA

The external monitor port, or VGA port, is an analog display interface that connects an external VGA display device such as an external VGA monitor or a VGA projector to the computer.

- ▲ To connect a VGA display device, connect the device cable to the external monitor port.

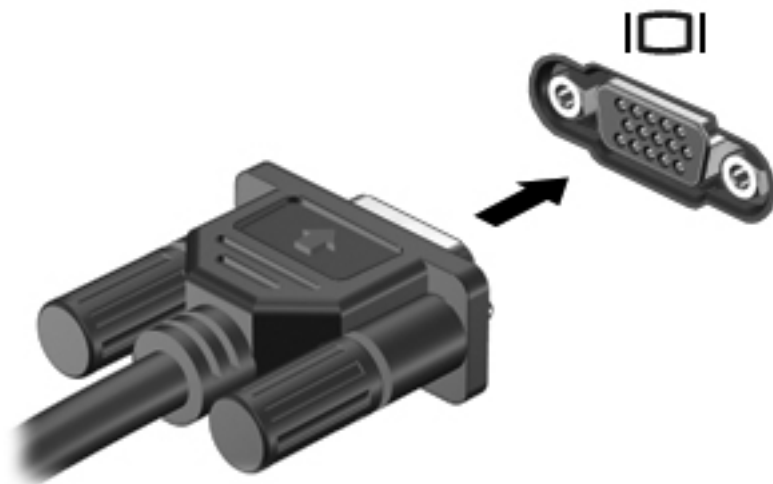

---

 **NOTE:** Press **fn+f4** to switch the image between the display devices connected to the computer. If an external display device does not display an image or is not recognized by the computer, it may require additional configuration using the GNOME Display Applet or the ATI configuration utility depending on which graphics card is installed in the computer.

---

If your external monitor is not detected after pressing **fn+f4**, follow these steps:



---

**NOTE:** If you have an AMD card, follow the instructions in the next section.

---

1. Click the **Gnome Display Applet** icon in the notification area at the far right of the taskbar.
2. Click **Detect Monitors**.
3. Click the **On** radio button to the right of the display layout. If the default monitor is not detected, set the resolution and the refresh rate using your external monitor specifications. Change the rotation if desired. If the display requires mirroring, click the **Mirror Screens** check box.



---

**NOTE:** Click **Default** to change the external monitor to landscape mode.

---

4. Click **Apply**.
5. Click **Close**.

If your external monitor is not detected after pressing **fn+f4**, and you have an AMD graphics card, follow these steps:

1. Select **Computer > More Applications > System > ATI Catalyst Control Center (as Superuser)**.
2. Enter your root password.
3. Select **Display Manager** from the right pane.
4. Click the **Detect connected displays** button.
5. Your display settings can be modified by clicking your monitor in the dialog box, and then selecting the **Display properties** tab or **Multi-Display** tab.
6. After the settings are configured, click **Apply**, and then click **OK**. Your computer may require rebooting.

## DisplayPort

The DisplayPort connects a digital display device such as a high-performance monitor or projector. The DisplayPort delivers higher performance than the VGA external monitor port and improves digital connectivity.

- ▲ To connect a digital display device, connect the device cable to the DisplayPort.



---

 **NOTE:** Press **fn+f4** to switch the image between the display devices connected to the computer.

 **NOTE:** To remove the device cable, press down on the connector latch to disconnect it from the computer.

---

---

# 6 Power management

The following sections are included in this chapter:

- [Shutting down the computer](#)
- [Setting power options](#)
- [Using battery power](#)
- [Using external AC power](#)

## Shutting down the computer

---

 **CAUTION:** Unsaved information will be lost when the computer is shut down.

---

The shutdown command closes all open programs, including the operating system, and then turns off the display and computer.

Shut down the computer under any of the following conditions:

- When you need to replace the battery or access components inside the computer
- When you are connecting an external hardware device that does not connect to a USB port
- When the computer will be unused and disconnected from external power for an extended period

To shut down the computer, follow these steps:

---

 **NOTE:** If the computer is in the Suspend state or in Hibernation, you must first exit Suspend or Hibernation before shutdown is possible.

---

1. Save your work and close all open programs.
2. Select **Computer > Shutdown > Shut Down**.

If the computer is unresponsive and you are unable to use the preceding shutdown procedure, try the following emergency procedures in the sequence provided:

- Press and hold the power button for at least 5 seconds.
- Disconnect the computer from external power, and then remove the battery.

# Setting power options

## Using power-saving states

The computer has two power-saving states enabled at the factory: Suspend and Hibernation.

When Suspend is initiated, the power lights blink and the screen clears. Your work is saved to memory, letting you exit the Suspend state faster than exiting Hibernation. If the computer is in the Suspend state for an extended period or if the battery reaches a critical battery level while in the Suspend state, the computer initiates Hibernation.

When Hibernation is initiated, your work is saved to a hibernation file on the hard drive and the computer turns off.

---

 **CAUTION:** To prevent possible audio and video degradation, loss of audio or video playback functionality, or loss of information, do not initiate Suspend or Hibernation while reading from or writing to a disc or an external media card.

 **NOTE:** You cannot initiate any type of networking connection or perform any computer functions while the computer is in the Suspend state or in Hibernation.

---

## Initiating and exiting Suspend

The system is set at the factory to initiate Suspend after a period of inactivity when running on battery power or on external power.

Power settings and timeouts can be changed using Power Management in Control Center.

With the computer on, you can initiate Suspend in any of the following ways:

- Briefly press the power button.
- Close the display.

---

 **NOTE:** This only works when the computer is running on battery power.

---

- Select **Computer > Shutdown > Suspend**.
- Click the **Power** icon, located on the far right of the taskbar, and then click **Suspend**.

To exit Suspend:

- ▲ Briefly press the power button.

When the computer exits Suspend, the power lights turn on and your work returns to the screen where you stopped working.

## Initiating and exiting Hibernation

The system is set at the factory to initiate Hibernation after a period of inactivity when running on battery power or on external power, or when the battery reaches a critical battery level.

Power settings and timeouts can be changed using Power Management in Control Center.

With the computer on, you can initiate Hibernation in any of the following ways:

- Briefly press the power button.
- Select **Computer > Shutdown > Hibernate**.
- Click the **Power** icon, located on the far right of the taskbar, and then click **Hibernate**.

To exit Hibernation:

- ▲ Briefly press the power button.

When the computer exits Hibernation, the power lights turn on and your work returns to the screen where you stopped working.

## Using the Power icon

The **Power** icon is located in the notification area, at the far right of the taskbar. The **Power** icon allows you to quickly access power settings, view remaining battery charge, and select a different power plan.

- To display the percentage of remaining battery charge, click the **Power** icon, and then click **Information**.
- To access Power Management Preferences, click the **Power** icon, and then click **Preferences**.

## Using power management

Power management is a collection of system settings that manages how the computer uses power. Power management can help you conserve power or maximize performance.

You can customize power management settings.

### Viewing the current power management settings

- ▲ Right-click the **Power** icon in the notification area, at the far right of the taskbar, and then click **Preferences**.

### Changing the current power management settings

1. Right-click the **Power** icon in the notification area, at the far right of the taskbar, and then click **Preferences**.
2. Change the settings on the **On AC Power** tab, **On Battery Power** tab, and **General** tab, as needed.

## Using battery power

When a charged battery is in the computer and the computer is not plugged into external power, the computer runs on battery power. When a charged battery is in the computer and the computer is plugged into external AC power, the computer runs on AC power.

If the computer contains a charged battery and is running on external AC power supplied through the AC adapter, the computer switches to battery power if the AC adapter is disconnected from the computer.

---

 **NOTE:** When you disconnect AC power, the display brightness is automatically decreased to save battery life. For information on increasing or decreasing display brightness, refer to [Keyboard and pointing devices on page 23](#).

---

You can keep a battery in the computer or in storage, depending on how you work. Keeping the battery in the computer whenever the computer is plugged into AC power charges the battery and also protects your work in case of a power outage. However, a battery in the computer slowly discharges when the computer is off and unplugged from external power.

---

 **WARNING!** To reduce potential safety issues, use only the battery provided with the computer, a replacement battery provided by HP, or a compatible battery purchased from HP.

---

Computer battery life varies, depending on power management settings, programs running on the computer, display brightness, external devices connected to the computer, and other factors.

## Displaying the remaining battery charge

- ▲ Move the pointer over the **Power** icon in the notification area, at the far right of the taskbar.

## Inserting or removing the battery

To insert the battery:

1. Turn the computer upside down on a flat surface, with the battery bay toward you.
2. Insert the battery (1) into the battery bay until it is seated.

The battery release latch (2) automatically locks the battery into place.

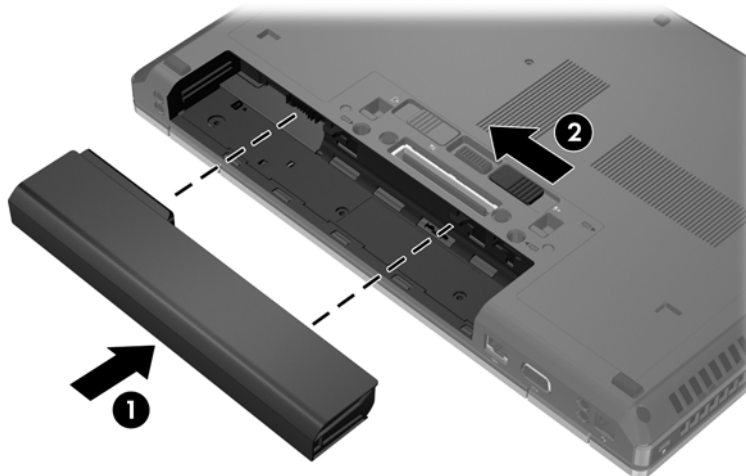

To remove the battery:

**⚠ CAUTION:** Removing a battery that is the sole power source may cause loss of information. To prevent loss of information, save your work and initiate Hibernation or shut down the computer before removing the battery.

1. Turn the computer upside down on a flat surface, with the battery bay toward you.
2. Slide the battery release latch (1) to release the battery.
3. Remove the battery from the computer (2).

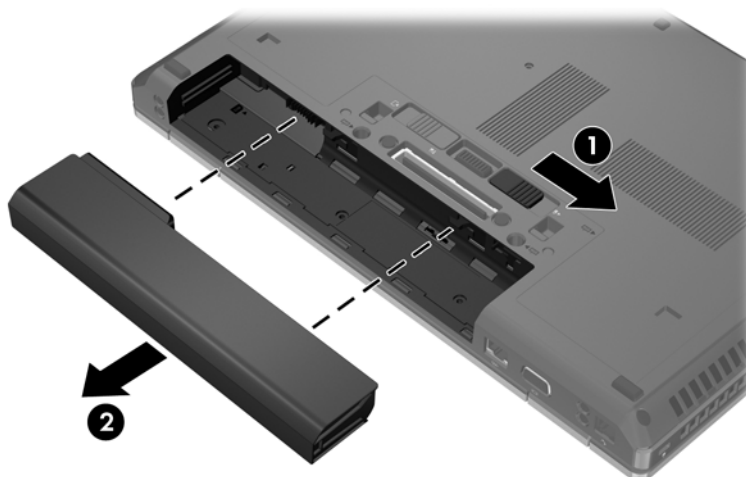

## Charging a battery

---

 **WARNING!** Do not charge the computer battery while you are onboard aircraft.

---

The battery charges whenever the computer is plugged into external power through an AC adapter or an optional power adapter.

The battery charges whether the computer is off or in use, but it charges faster when the computer is off.

Charging may take longer if a battery is new, has been unused for 2 weeks or more, or is much warmer or cooler than room temperature.

To prolong battery life and optimize the accuracy of battery charge displays, follow these recommendations:

- If you are charging a new battery, charge it fully before turning on the computer.



---

**NOTE:** If the computer is on while the battery is charging, the battery meter in the notification area may show 100 percent charge before the battery is fully charged.

---

- Allow the battery to discharge below 5 percent of a full charge through normal use before charging it.
- If the battery has been unused for one month or more, calibrate the battery instead of simply charging it.

## Maximizing battery life

To maximize battery life:

1. Select **Computer > Control Center**.
2. In the left pane, click **System**, and then click **Power Management** in the right pane.
3. On the **On Battery Power** tab:
  - Adjust the slider to the right of **Put computer to sleep when inactive for** to 30 minutes.
  - Select the **Suspend** or **Hibernate** option from the dialog box to the right of **When laptop lid is closed**.
  - Select the **Hibernate** or **Shutdown** option from the dialog box to the right of **When battery power is critically low**.
4. Adjust the slider to the right of **Put display to sleep when inactive for** to 15 minutes, and select the check box next to **Reduce backlight brightness**.
5. Select the check box next to **Dim display when idle**.
6. Click **Close**.

---

 **CAUTION:** Removing a battery that is the sole power source for the computer can cause loss of information. To prevent loss of information, save your work and initiate Hibernation or shut down the computer before removing the battery.

---

## Managing low battery levels

The information in this section describes the alerts and system responses set at the factory. Some low-battery alerts and system responses can be changed using Power Management in Control Center. Preferences set using Power Management do not affect lights.

### Identifying low battery levels

When a battery that is the sole power source for the computer reaches a low or critical battery level, the following behavior occurs:

- If Hibernation is enabled and the computer is on or in Suspend, the computer initiates Hibernation.
- If Hibernation is disabled and the computer is on or in Suspend, the computer remains briefly in Suspend, and then shuts down and loses any unsaved information.

## Resolving a low battery level

### Resolving a low battery level when external power is available

- ▲ Connect one of the following devices:
  - AC adapter
  - Optional docking or expansion device
  - Optional power adapter purchased as an accessory from HP

### Resolving a low battery level when a charged battery is available

1. Turn off the computer or initiate Hibernation.
2. Replace the discharged battery with a charged battery.
3. Turn on the computer.

### Resolving a low battery level when no power source is available

- Initiate Hibernation.
- Save your work and shut down the computer.

### Resolving a low battery level when the computer cannot exit Hibernation

When the computer lacks sufficient power to exit Hibernation, follow these steps:

1. Replace the discharged battery with a charged battery, or connect the AC adapter to the computer and to external power.
2. Exit Hibernation by briefly pressing the power button.

## Conserving battery power

- Turn off wireless and local area network (LAN) connections and exit modem applications when you are not using them.
- Disconnect unused external devices that are not plugged into an external power source.
- Stop, disable, or remove any external media cards that you are not using.
- Decrease brightness.
- Initiate Suspend or Hibernation, or shut down when you are not using the computer.

## Storing a battery

---

**⚠ CAUTION:** To reduce the risk of damage to a battery, do not expose it to high temperatures for extended periods of time.

---

If a computer will be unused and unplugged from external power for more than 2 weeks, remove the battery and store it separately.

To prolong the charge of a stored battery, place it in a cool, dry place.

---

 **NOTE:** A stored battery should be checked every 6 months. If the capacity is less than 50 percent, recharge the battery before returning it to storage.

---

Calibrate a battery before using it if it has been stored for one month or more.

## Disposing of a used battery

---

 **WARNING!** To reduce the risk of fire or burns, do not disassemble, crush, or puncture; do not short external contacts; do not dispose of in fire or water.

---

Refer to the *Regulatory, Safety, and Environmental Notices* for battery disposal information.

## Replacing the battery

Computer battery life varies, depending on power management settings, programs running on the computer, display brightness, external devices connected to the computer, and other factors.

You can find details about the battery by clicking the **Battery** icon in the notification area at the far right of the taskbar.

---

 **NOTE:** To ensure that you always have battery power when you need it, HP recommends purchasing a new battery when the storage capacity indicator turns green-yellow.

---

## Using external AC power

---

 **NOTE:** For information on connecting to AC power, refer to the *Setup Instructions* poster provided in the computer box.

---

External AC power is supplied through an approved AC adapter or an optional docking or expansion device.

---

 **WARNING!** To reduce potential safety issues, use only the AC adapter provided with the computer, a replacement AC adapter provided by HP, or a compatible AC adapter purchased from HP.

---

Connect the computer to external AC power under any of the following conditions:

---

 **WARNING!** Do not charge the battery while you are onboard aircraft.

---

- When you are charging or calibrating a battery
- When you are installing or modifying system software
- When writing information to a CD or DVD

When you connect the computer to external AC power, the following events occur:

- The battery begins to charge.
- If the computer is turned on, the **Battery** icon in the notification area changes appearance.

When you disconnect external AC power, the following events occur:

- The computer switches to battery power.
- The display brightness is automatically decreased to save battery life.

## Testing an AC adapter

Test the AC adapter if the computer exhibits any of the following symptoms when it is connected to AC power:

- The computer does not turn on.
- The display does not turn on.
- The power lights are off.

To test the AC adapter:

1. Shut down the computer.
2. Remove the battery from the computer.
3. Connect the AC adapter to the computer, and then plug it into an AC outlet.
4. Turn on the computer.
  - If the power lights turn **on**, the AC adapter is functioning properly.
  - If the power lights remain **off**, the AC adapter is not functioning and should be replaced.

Contact technical support for information on obtaining a replacement AC power adapter.

---

# 7 Drives

The following sections are included in this chapter:

- [Handling drives](#)
- [Removing or replacing the bottom cover](#)
- [Replacing or upgrading the hard drive](#)
- [Replacing a drive in the upgrade bay](#)
- [Using optical drives \(select models only\)](#)

## Handling drives

Drives are fragile computer components that must be handled with care. Refer to the following cautions before handling drives. Additional cautions are included with the procedures to which they apply.

Observe these precautions:

- Before you move a computer that is connected to an external hard drive, initiate Suspend and allow the screen to clear, or properly disconnect the external hard drive.
- Before handling a drive, discharge static electricity by touching the unpainted metal surface of the drive.
- Do not touch the connector pins on a removable drive or on the computer.
- Handle a drive carefully; do not drop a drive or place items on it.
- Before removing or inserting a drive, shut down the computer. If you are unsure whether the computer is off, in Suspend, or in Hibernation, turn the computer on, and then shut it down through the operating system.
- Do not use excessive force when inserting a drive into a drive bay.
- Do not type on the keyboard or move the computer while an optical drive is writing to a disc. The write process is sensitive to vibration.
- When the battery is the only source of power, be sure that the battery is sufficiently charged before writing to media.
- Avoid exposing a drive to temperature or humidity extremes.
- Avoid exposing a drive to liquids. Do not spray the drive with cleaning products.

- Remove media from a drive before removing the drive from the drive bay, or traveling with, shipping, or storing a drive.
- If a drive must be mailed, place the drive in a bubble-pack mailer or other suitable protective packaging and label the package “FRAGILE.”
- Avoid exposing a drive to magnetic fields. Security devices with magnetic fields include airport walk-through devices and security wands. Airport conveyer belts and similar security devices that check carry-on baggage use X-rays instead of magnetism and do not damage drives.

## Removing or replacing the bottom cover

---

 **CAUTION:** To prevent information loss or an unresponsive system:

Save your work and shut down the computer before adding or replacing a memory module or hard drive.

If you are not sure whether the computer is off or in Hibernation, turn the computer on by pressing the power button. Then shut down the computer through the operating system.

---

### Removing the bottom cover

Remove the bottom cover to access the memory module slot, hard drive, regulatory label, and other components.

To remove the bottom cover:

1. Remove the battery (see [Inserting or removing the battery on page 39](#)).
2. With the battery bay toward you, slide the bottom cover release latch **(1)** to the left, remove the screw (if the optional screw is being used) **(2)**, and then slide the release latch again **(3)** to release the bottom cover.

---

 **NOTE:** If you want to use the optional screw, it is stored inside the bottom cover.

---

3. Slide the bottom cover towards the front of the computer **(4)** and lift up **(5)** to remove the cover.

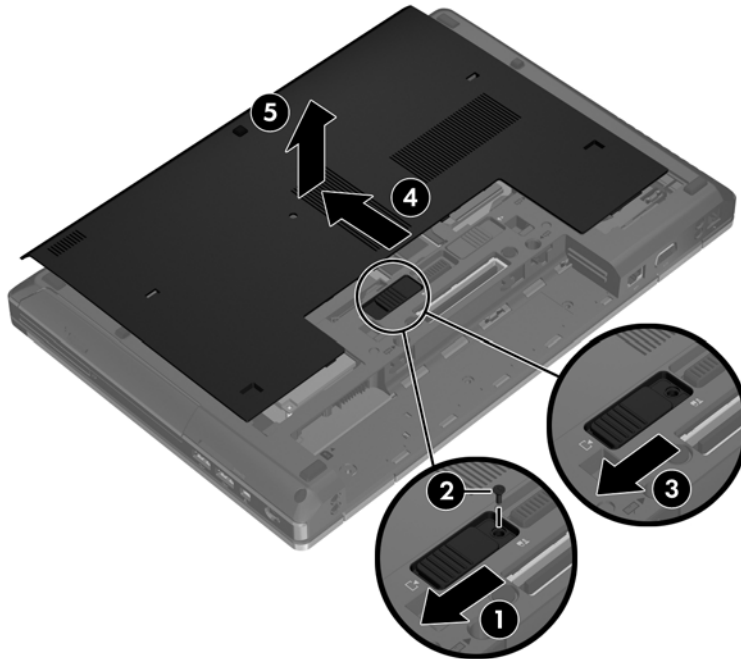

## Replacing the bottom cover

Replace the bottom cover after accessing the memory module slot, hard drive, regulatory label, and other components.

To replace the bottom cover:

1. Tilt the bottom cover down to align the front edge of the bottom cover near the front edge of the computer **(1)**.
2. Insert the alignment tabs on the rear edge of the bottom cover with the notches on the computer.
3. Slide the bottom cover towards the battery bay **(2)** until the bottom cover snaps into place.

4. With the battery bay toward you, slide the bottom cover release latch to the left **(3)**, and if you choose to, insert and tighten the optional screw **(4)** to hold the bottom cover in place. Slide the release latch to the right to lock the bottom cover **(5)**.

 **NOTE:** If you want to use the optional screw, it is stored inside the bottom cover.

---

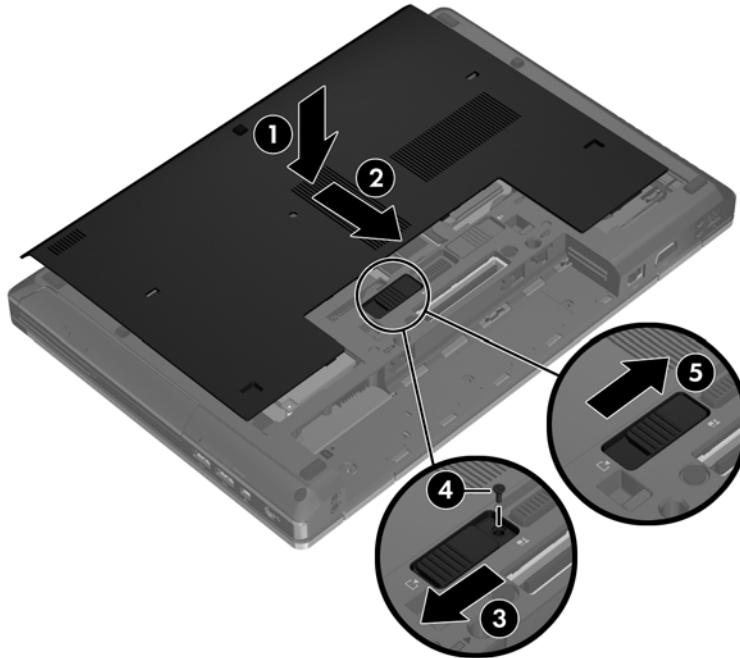

5. Insert the battery (see [Inserting or removing the battery on page 39](#)).

# Replacing or upgrading the hard drive

**⚠ CAUTION:** To prevent information loss or an unresponsive system:

Shut down the computer before removing the hard drive from the hard drive bay. Do not remove the hard drive while the computer is on, in the Suspend state, or in Hibernation.

If you are not sure whether the computer is off or in Hibernation, turn the computer on by pressing the power button. Then shut down the computer through the operating system.

## Removing the hard drive

To remove the hard drive:

1. Save your work and shut down the computer.
2. Disconnect AC power and external devices connected to the computer.
3. Remove the battery (see [Inserting or removing the battery on page 39](#)).
4. Remove the bottom cover (see [Removing the bottom cover on page 46](#)).
5. Loosen the 3 hard drive screws (1).
6. Pull the plastic tab on the hard drive (2) towards the side of the computer to disengage the hard drive from the connector.
7. Use the plastic tab to lift the hard drive up at an angle (3) and remove the drive (4) from the computer.

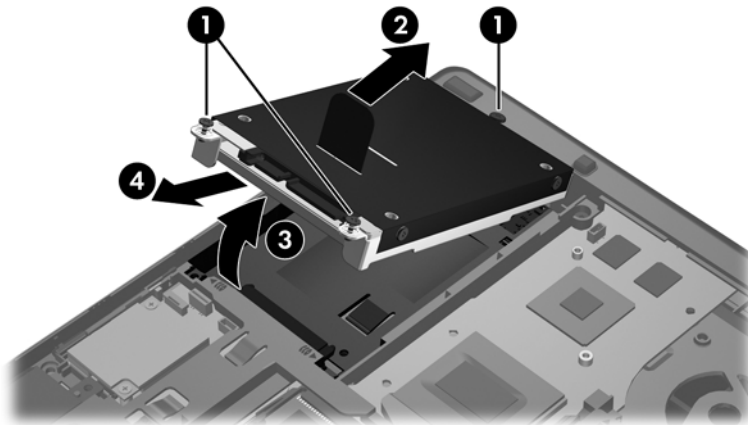

## Installing a hard drive

To install the hard drive:

1. Insert the hard drive into the hard drive bay at an angle (1), and then lay the hard drive flat in the hard drive bay (2).
2. Pull the plastic tab (3) towards the center of the computer to engage the hard drive with the connector.

3. Tighten the hard drive screws (4).

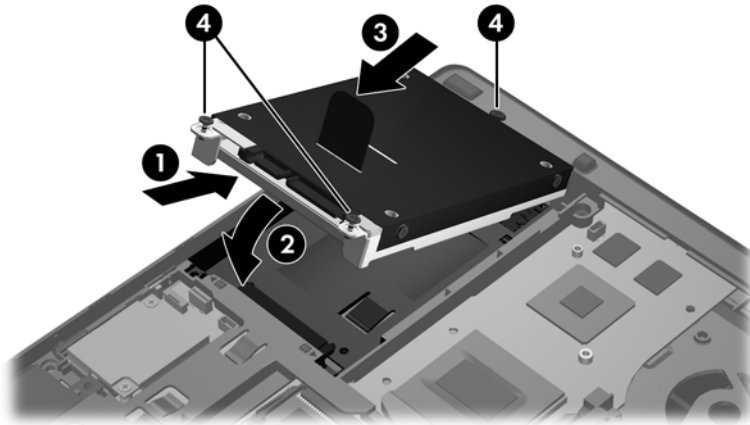

4. Replace the bottom cover (see [Replacing the bottom cover on page 47](#)).
5. Insert the battery (see [Inserting or removing the battery on page 39](#)).
6. Connect AC power and external devices to the computer.
7. Turn on the computer.

## Replacing a drive in the upgrade bay

The upgrade bay can hold either a hard drive or an optical drive.

### Replacing a hard drive

**⚠ CAUTION:** To prevent information loss or an unresponsive system:

Shut down the computer before removing the hard drive from the upgrade bay. Do not remove the hard drive while the computer is on, in the Suspend state, or in Hibernation.

If you are not sure whether the computer is off or in Hibernation, turn the computer on by pressing the power button. Then shut down the computer through the operating system.

To remove a hard drive from the upgrade bay:

1. Save your work.
2. Shut down the computer and close the display.
3. Disconnect all external hardware devices connected to the computer.
4. Unplug the power cord from the AC outlet.
5. Turn the computer upside down on a flat surface, with the upgrade bay toward you.
6. Remove the battery (see [Inserting or removing the battery on page 39](#)).
7. Remove the bottom cover (see [Removing the bottom cover on page 46](#)).

8. Remove the hard drive screws from the upgrade bay.

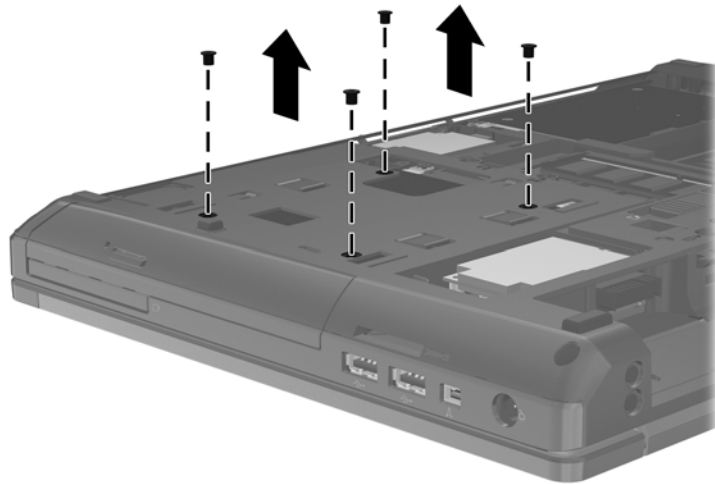

9. Loosen the upgrade bay screw (1).
10. Using a flat-bladed screwdriver, gently push the tab to release the hard drive (2).
11. Remove the hard drive from the upgrade bay (3).



To install a hard drive in the upgrade bay:

1. Insert the hard drive (1) into the upgrade bay, and then tighten the upgrade bay screw (2).



2. Replace the hard drive screws.

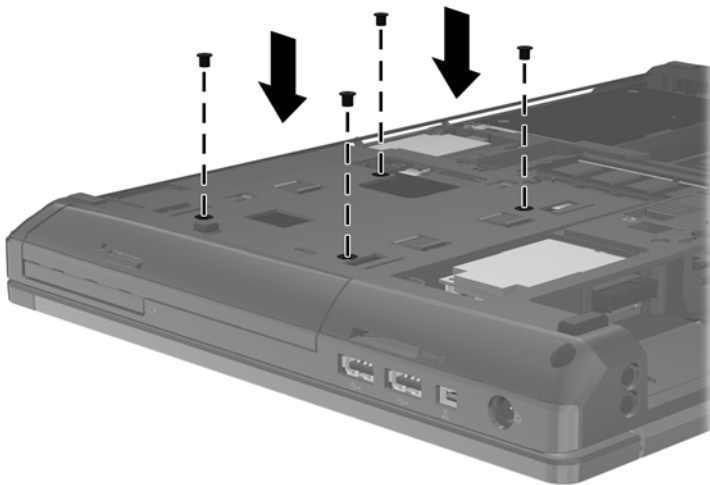

3. Replace the bottom cover (see [Replacing the bottom cover on page 47](#)).
4. Insert the battery (see [Inserting or removing the battery on page 39](#)).
5. Turn the computer right-side up, and then reconnect AC power and external devices to the computer.
6. Turn on the computer.

## Replacing an optical drive

**⚠ CAUTION:** To prevent information loss or an unresponsive system:

Shut down the computer before removing the optical drive from the upgrade bay. Do not remove the optical drive while the computer is on, in the Suspend state, or in Hibernation.

If you are not sure whether the computer is off or in Hibernation, turn the computer on by pressing the power button. Then shut down the computer through the operating system.

To remove an optical drive from the upgrade bay:

1. Save your work.
2. Shut down the computer and close the display.
3. Disconnect all external hardware devices connected to the computer.
4. Unplug the power cord from the AC outlet.
5. Turn the computer upside down on a flat surface, with the upgrade bay toward you.
6. Remove the battery (see [Inserting or removing the battery on page 39](#)).
7. Remove the bottom cover (see [Removing the bottom cover on page 46](#)).
8. Loosen the upgrade bay screw (1).
9. Using a flat-bladed screwdriver, gently push the tab to release the optical drive (2).
10. Remove the optical drive from the upgrade bay (3).

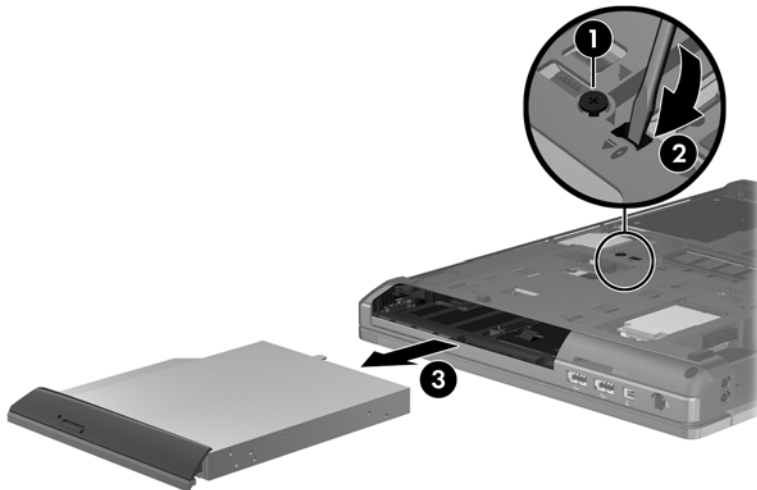

To install an optical drive in the upgrade bay:

1. Insert the optical drive into the upgrade bay (1).

2. Tighten the upgrade bay screw (2).

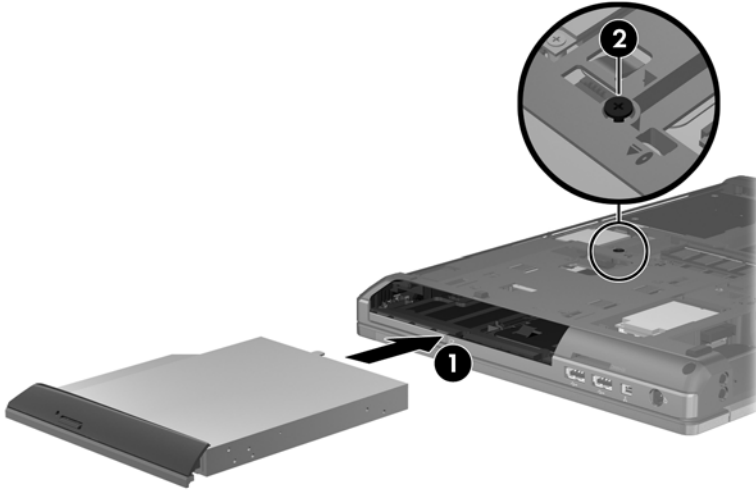

3. Replace the bottom cover (see [Replacing the bottom cover on page 47](#)).
4. Insert the battery (see [Inserting or removing the battery on page 39](#)).
5. Turn the computer right-side up, and then reconnect AC power and external devices to the computer.
6. Turn on the computer.

# Using optical drives (select models only)

## Identifying the installed optical drive

- ▲ Select **Computer > More Applications**, and then select the **Audio & Video** group at the left sidebar.

A list of all the devices installed in your computer, including your optical drive, is displayed.

## Inserting an optical disc

### Tray load

1. Turn on the computer.
2. Press the release button (1) on the drive bezel to release the disc tray.
3. Pull out the tray (2).
4. Hold the disc by the edges to avoid touching the flat surfaces and position the disc label-side up over the tray spindle.

---

 **NOTE:** If the tray is not fully accessible, tilt the disc carefully to position it over the spindle.

---

5. Gently press the disc (3) down onto the tray spindle until the disc snaps into place.

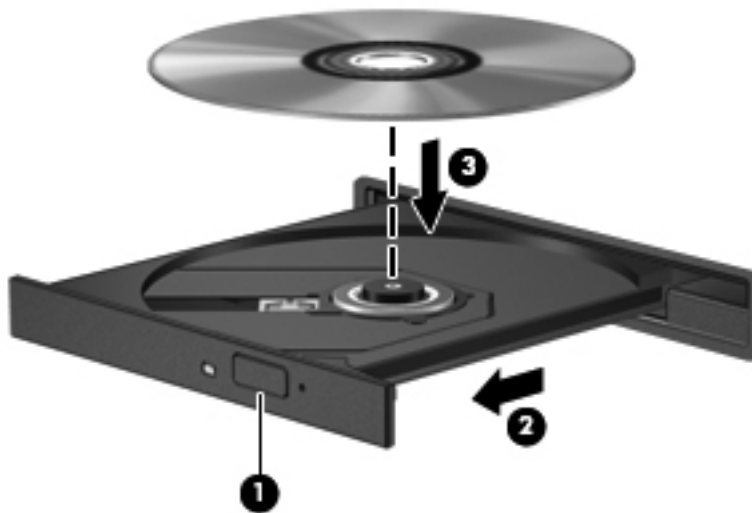

6. Close the disc tray.

---

 **NOTE:** After you insert a disc, a short pause is normal. If you have not selected a media player, an AutoPlay dialog box opens. It prompts you to select how you want to use the media content.

---

## Slot load

**CAUTION:** Do not insert **8-cm** optical discs into a slot load optical drive. It may cause damage to the optical drive.

1. Turn on the computer.
2. Hold the disc by the edges to avoid touching the flat surfaces and position the disc label-side up.
3. Gently slide the disc into the slot load optical drive.



## Removing an optical disc

### Tray load

There are 2 ways to remove a disc, depending on whether the disc tray opens normally or not.

#### When the disc tray opens normally

1. Press the release button **(1)** on the drive bezel to release the disc tray, and then gently pull out the tray **(2)** until it stops.

2. Remove the disc **(3)** from the tray by gently pressing down on the spindle while lifting the outer edges of the disc. Hold the disc by the edges and avoid touching the flat surfaces.



**NOTE:** If the tray is not fully accessible, tilt the disc carefully as you remove it.

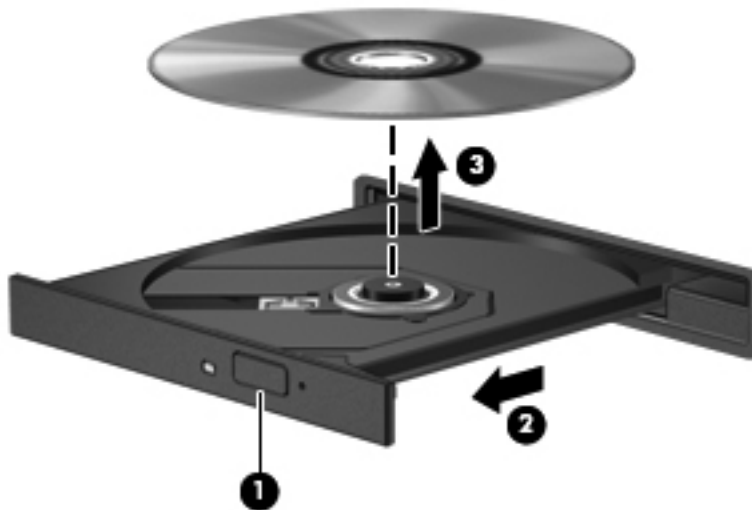

3. Close the disc tray and place the disc in a protective case.

#### When the disc tray fails to open

1. Insert the end of a paper clip **(1)** into the release access in the front bezel of the drive.
2. Press in gently on the paper clip until the tray is released, and then pull out the tray **(2)** until it stops.

3. Remove the disc **(3)** from the tray by gently pressing down on the spindle while lifting the outer edges of the disc. Hold the disc by the edges and avoid touching the flat surfaces.

 **NOTE:** If the tray is not fully accessible, tilt the disc carefully as you remove it.

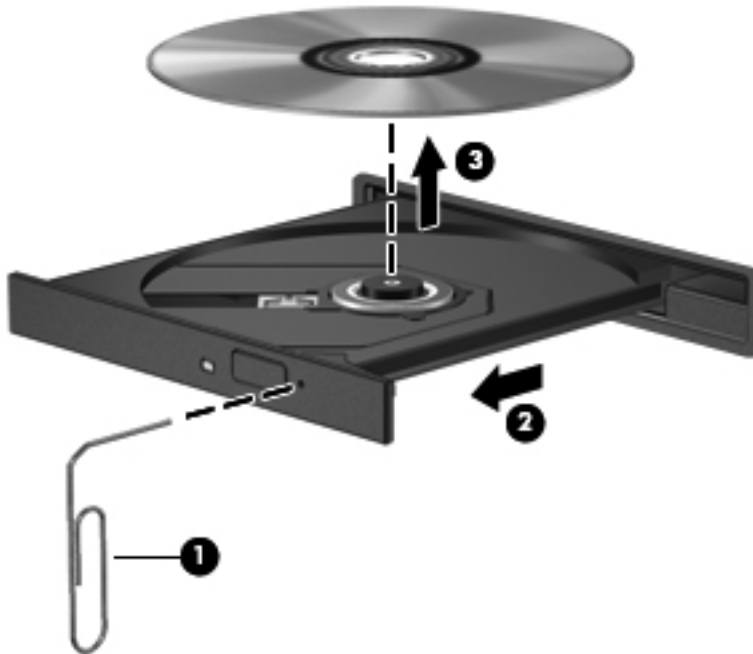

4. Close the disc tray and place the disc in a protective case.

### Slot load

1. Press the release button **(1)** next to the drive.
2. Remove the disc **(2)** by holding it by the edges and avoid touching the flat surfaces.



3. Place the disc in a protective case.

---

# 8 External cards and devices

The following sections are included in this chapter:

- [Using Media Card Reader cards](#)
- [Using ExpressCards \(select models only\)](#)
- [Using a USB device](#)
- [Using 1394 devices](#)
- [Using an eSATA device](#)
- [Using optional external devices](#)
- [Using the docking connector](#)

## Using Media Card Reader cards

Optional media cards provide secure data storage and convenient data sharing. These cards are often used with digital media-equipped cameras and PDAs as well as with other computers.

To determine which media card formats that are supported on your computer, refer to [Getting to know your computer on page 3](#).

### Inserting a media card

---

 **CAUTION:** To reduce the risk of damage to the media card connectors, use minimal force to insert a media card.

---

1. Hold the media card label-side up, with the connectors facing the computer.

2. Insert the card into the Media Card Reader, and then push in on the card until it is firmly seated.

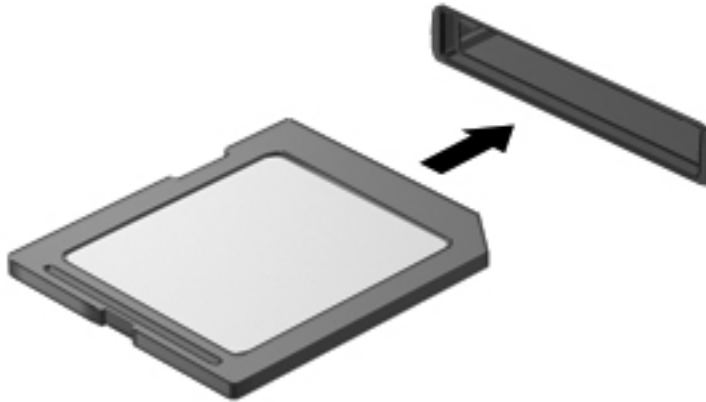

## Removing a media card

---

**CAUTION:** To reduce the risk of loss of data or an unresponsive system, use the following procedure to safely remove the media card.

---

Save your information and close all programs associated with the media card.

To remove a media card:

1. Open File Browser by selecting **Computer > Nautilus**.
2. Click the **Eject** icon next to the name of the media card in the **Places** list on the left pane of File Browser.

---

**NOTE:** You are prompted that it is safe to remove the hardware device.

---

3. Press in on the card (1), and then remove it from the slot (2).

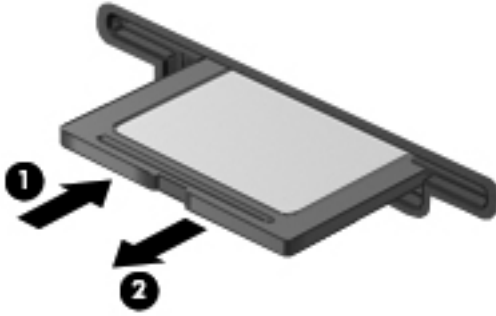

– or –

Pull the card out of the slot.

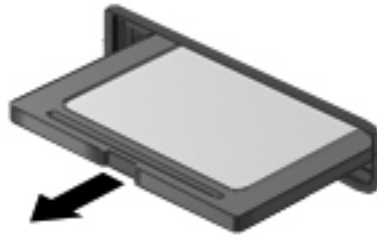

## Using ExpressCards (select models only)

An ExpressCard is a high-performance PC Card that is inserted into the ExpressCard slot.

Like standard PC Cards, ExpressCards are designed to conform to the standard specifications of the Personal Computer Memory Card International Association (PCMCIA), but application software to use the device may be required for this operating system.

---

 **NOTE:** To conserve power, stop or remove an ExpressCard when it is not in use.

---

## Configuring an ExpressCard

Install only the software required for the card. If you are instructed by the ExpressCard manufacturer to install device drivers:

- Install only the device drivers for your operating system.
- Do not install additional software, such as card services, socket services, or enablers, that are supplied by the ExpressCard manufacturer.

## Inserting an ExpressCard

**CAUTION:** To prevent damage to the computer and external media cards, do not insert a PC Card into an ExpressCard slot.

**CAUTION:** To reduce the risk of damage to the connectors:

Use minimal force when inserting an ExpressCard.

Do not move or transport the computer when an ExpressCard is in use.

The ExpressCard slot may contain a protective insert. To remove the insert:

1. Press in on the insert (1) to unlock it.
2. Pull the insert out of the slot (2).

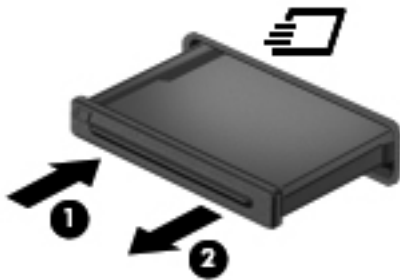

To insert an ExpressCard:

1. Hold the card label-side up, with the connectors facing the computer.
2. Insert the card into the ExpressCard slot, and then press in on the card until it is firmly seated.

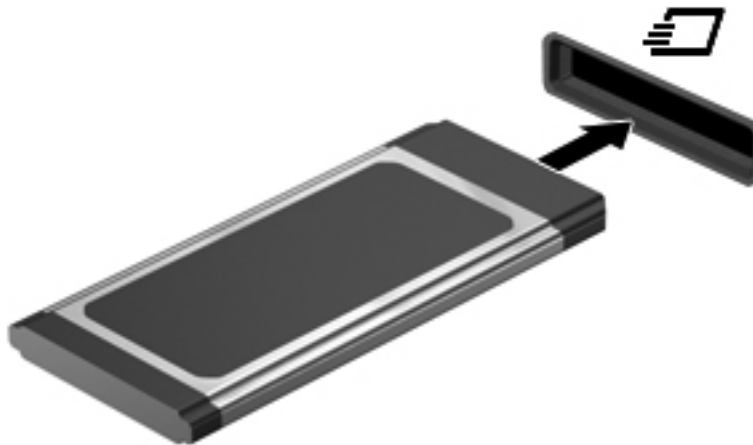

## Removing an ExpressCard

**CAUTION:** To reduce the risk of loss of data or an unresponsive system, use the following procedure to safely remove the ExpressCard.

Save your information and close all programs associated with the ExpressCard.

To remove an ExpressCard:

1. Open File Browser by selecting **Computer > Nautilus**.
2. Click the **Eject** icon next to the name of the media card in the Places list on the left pane of File Browser.

You are prompted that it is safe to remove the hardware device.

**NOTE:** Ejecting the ExpressCard from Nautilus is only required if it is a storage device.

3. Release and remove the ExpressCard:
  - a. Gently press in on the ExpressCard **(1)** to unlock it.
  - b. Pull the ExpressCard out of the slot **(2)**.

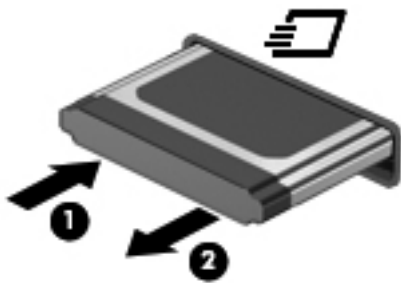

## Using a USB device

Universal Serial Bus (USB) is a hardware interface that can be used to connect an optional external device, such as a USB keyboard, mouse, drive, printer, scanner, or hub. Devices can be connected to the system.

Some USB devices may require additional support software, which is usually included with the device. For more information about device-specific software, refer to the manufacturer's instructions.

The computer has 3 USB ports which support USB 2.0 devices. An optional USB hub provides additional USB ports that can be used with the computer.

## Connecting a USB storage device

---

 **CAUTION:** To prevent damage to a USB connector, use minimal force to connect a USB device.

---

- ▲ To connect a USB device to the computer, connect the USB cable for the device to the USB port.



---

 **NOTE:** When you connect a USB device, you may see a message in the notification area to let you know that the device is recognized by the system.

---

## Removing a USB device

---

 **CAUTION:** To prevent damage to a USB connector, do not pull on the cable to remove the USB device.

**CAUTION:** To prevent loss of information or an unresponsive system, use the following procedure to safely remove a USB device.

---

To remove a USB device:

1. Open File Browser by selecting **Computer > Nautilus**.
2. Click the **Eject** icon next to the name of the device in the **Places** list on the left pane of File Browser.

---

 **NOTE:** Ejecting a USB device from Nautilus is only required if it is a storage device.

---

3. Remove the device.

## Using 1394 devices

IEEE 1394 is a hardware interface that connects a high-speed multimedia or data storage device to the computer. Scanners, digital cameras, and digital camcorders often require a 1394 connection.

Some 1394 devices may require additional support software, which is usually included with the device. For more information about device-specific software, refer to the manufacturer's instructions.

The 1394 port also supports IEEE 1394a devices.

## Connecting a 1394 device

---

 **CAUTION:** To reduce the risk of damage to a 1394 port connector, use minimal force to connect the device.

---

- ▲ To connect a 1394 device to the computer, connect the 1394 cable for the device to the 1394 port.

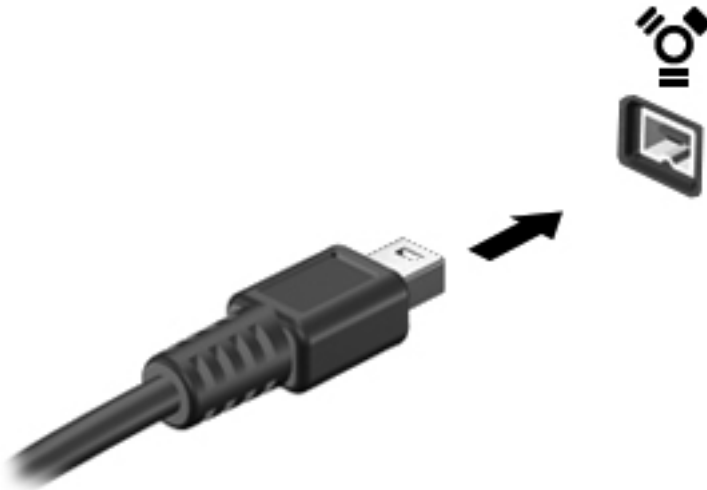

---

 **NOTE:** When you connect a 1394 device, you may see a message in the notification area to let you know that the device is recognized by the system.

---

## Removing a 1394 device

---

 **CAUTION:** To reduce the risk of loss of information or an unresponsive system, stop the 1394 device before removing it.

**CAUTION:** To reduce the risk of damage to a 1394 connector, do not pull on the cable to remove the 1394 device.

---

To remove a 1394 device:

1. Open File Browser by selecting **Computer > Nautilus**.
2. Click the **Eject** icon next to the name of the device in the Places list on the left pane of File Browser.

---

 **NOTE:** Ejecting a 1394 device from Nautilus is only required if it is a storage device.

---

3. Remove the device.

## Using an eSATA device

An eSATA port connects an optional high-performance eSATA component, such as an eSATA external hard drive.

Some eSATA devices may require additional support software, which is usually included with the device. For more information about device-specific software, refer to the manufacturer's instructions.

---

 **NOTE:** The eSATA port also supports an optional USB device.

---

## Connecting an eSATA device

---

 **CAUTION:** To reduce the risk of damage to an eSATA port connector, use minimal force to connect the device.

---

- ▲ To connect an eSATA device to the computer, connect the eSATA cable for the device to the eSATA port.

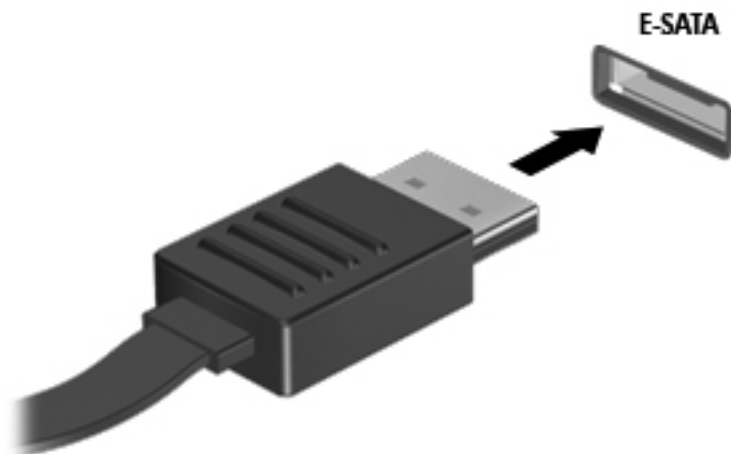

---

 **NOTE:** When you connect an eSATA device, you may see a message in the notification area to let you know that the device is recognized by the system.

---

## Removing an eSATA device

---

 **CAUTION:** To reduce the risk of damage to an eSATA connector, do not pull on the cable to remove the eSATA device.

**CAUTION:** To reduce the risk of loss of information or an unresponsive system, use the following procedure to safely remove the device.

---

To remove an eSATA device:

1. Open File Browser by selecting **Computer > Nautilus**.
2. Click the **Eject** icon next to the name of the device in the Places list on the left pane of File Browser.
3. Remove the device.

## Using optional external devices

 **NOTE:** For more information about required software and drivers, or to learn which computer port to use, refer to the manufacturer's instructions.

---

To connect an external device to the computer:

 **CAUTION:** To reduce the risk of damage to the equipment when connecting a powered device, be sure that the device is turned off and the AC power cord is unplugged.

---

1. Connect the device to the computer.
2. If you are connecting a powered device, plug the device power cord into a grounded AC outlet.
3. Turn on the device.

To disconnect an unpowered external device, turn off the device, and then disconnect it from the computer. To disconnect a powered external device, turn off the device, disconnect it from the computer, and then unplug the AC power cord.

## Using optional external drives

Removable external drives expand your options for storing and accessing information. A USB drive can be added by connecting the drive to a USB port on the computer.

USB drives include the following types:

- 1.44-megabyte diskette drive
- External hard drive (a hard drive with an adapter attached)
- External optical drive (CD and DVD)
- MultiBay device

## Using the docking connector

The docking connector connects the computer to an optional docking device. An optional docking device provides additional ports and connectors that can be used with the computer.

 **NOTE:** The following image may look different from your computer or docking device.

---

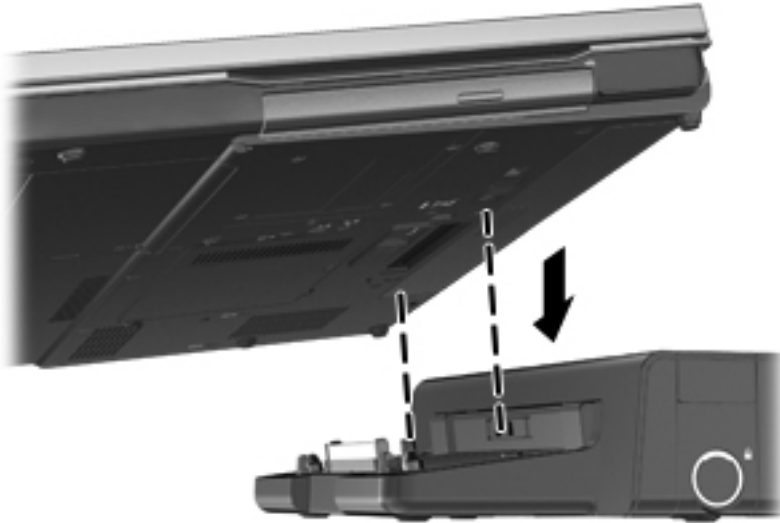



---

# 9 Memory modules

The computer has one memory module compartment. The capacity of the computer can be upgraded by adding a memory module to the vacant expansion memory module slot or by upgrading the existing memory module in the primary memory module slot.

---

 **WARNING!** To reduce the risk of electric shock and damage to the equipment, unplug the power cord and remove all batteries before installing a memory module.

 **CAUTION:** Electrostatic discharge (ESD) can damage electronic components. Before beginning any procedure, ensure that you are discharged of static electricity by touching a grounded metal object.

 **NOTE:** To use a dual-channel configuration when adding a second memory module, be sure that both memory modules are identical.

---

To add or replace a memory module:

---

 **CAUTION:** To prevent information loss or an unresponsive system:

Shut down the computer before adding or replacing memory modules. Do not remove a memory module while the computer is on, in the Suspend state, or in Hibernation.

If you are not sure whether the computer is off or in Hibernation, turn the computer on by pressing the power button. Then shut down the computer through the operating system.

---

1. Save your work and shut down the computer.
2. Disconnect AC power and external devices connected to the computer.
3. Turn the computer upside down on a flat surface.
4. Remove the battery. (Refer to [Inserting or removing the battery on page 39.](#))
5. Remove the bottom cover. (Refer to [Removing or replacing the bottom cover on page 46.](#))
6. If you are replacing a memory module, remove the existing memory module:
  - a. Pull away the retention clips **(1)** on each side of the memory module.

The memory module tilts up.

---

 **CAUTION:** To prevent damage to the memory module, hold the memory module by the edges only. Do not touch the components on the memory module, and do not bend the memory module.

---



10. Turn the computer right-side up, and then reconnect AC power and external devices to the computer.
11. Turn on the computer.

# 10 Security

The following sections are included in this chapter:

- [Protecting the computer](#)
- [Using passwords](#)
- [Using firewall software](#)
- [Installing an optional security cable](#)

## Protecting the computer



**NOTE:** Security solutions are designed to act as deterrents, but they may not deter software attacks or prevent the computer from being mishandled or stolen.

Security features provided with your computer can protect the computer, personal information, and data from a variety of risks. The way you use your computer will determine which security features you need to use.

The operating system offers certain security features. Additional security features are listed in the following table. Most of these additional security features can be configured in Computer Setup.

To protect against	Use this security feature
Unauthorized use of the computer	Power-on authentication using passwords
Unauthorized access to Computer Setup (f10)	Administrator password in Computer Setup*
Unauthorized access to the contents of a hard drive	DriveLock password in Computer Setup*
Unauthorized reset of Computer Setup (f10) passwords	Stringent security feature in Computer Setup*
Unauthorized startup from an optical drive, diskette drive, or internal network adapter	Boot options feature in Computer Setup*
Unauthorized access to data	<ul style="list-style-type: none"><li>• Firewall software</li><li>• Operating system updates</li></ul>
Unauthorized access to Computer Setup settings and other system identification information	Administrator password in Computer Setup*
Unauthorized removal of the computer	Security cable slot (used with an optional security cable)

\*Computer Setup is a utility accessed by pressing f10 when the computer is turned on or restarted. When using Computer Setup, you must use the keys on your computer to navigate and make selections.

# Using passwords

A password is a group of characters that you choose to secure your computer information. Several types of passwords can be set, depending on how you want to control access to your information. Passwords can be set in the operating system or in Computer Setup that is preinstalled on the computer.



**NOTE:** To reduce the risk of being locked out of the computer, record each password and store it in a secure place.

## Setting passwords in the operating system

Operating system passwords	Function
Root password	Protects access to an operating system root-level account.
User password	Protects access to an operating system user account.

## Setting passwords in Computer Setup

Computer Setup passwords	Function
Administrator password*	<ul style="list-style-type: none"><li>Protects access to Computer Setup.</li><li>After this password is set, it must be entered each time you access Computer Setup.</li></ul> <p><b>CAUTION:</b> If you forget your administrator password, you cannot access Computer Setup.</p> <p><b>NOTE:</b> The administrator password can be used in place of the power-on password.</p> <p><b>NOTE:</b> Your administrator password is not displayed as it is set, entered, changed, or deleted.</p> <p><b>NOTE:</b> If you enter the power-on password at the first password check before the "Press the ESC key for Startup Menu" message is displayed, you must enter the administrator password to access Computer Setup.</p>
Power-on password*	<ul style="list-style-type: none"><li>Protects access to the computer contents.</li><li>After this password is set, it must be entered each time you turn on or restart the computer, or exit Hibernation.</li></ul> <p><b>CAUTION:</b> If you forget your power-on password, you cannot turn on or restart the computer, or exit Hibernation.</p> <p><b>NOTE:</b> The administrator password can be used in place of the power-on password.</p> <p><b>NOTE:</b> A power-on password is not displayed as it is set, entered, changed, or deleted.</p>

\*For details about each of these passwords, refer to the following topics.

## Managing an administrator password

To set, change, or delete this password, follow these steps:

1. Open Computer Setup by turning on or restarting the computer. While the “Press the ESC key for Startup Menu” message is displayed in the lower-left corner of the screen, press **esc**. When the Startup Menu is displayed, press **f10**.
2. Use the arrow keys to select **Security > Set Administrator password**, and then press **enter**.
  - To set an administrator password, type your password in the **Enter New Password** and **Confirm New Password** fields, and then press **enter**.
  - To change an administrator password, type your current password in the **Enter Current Password** field, type a new password in the **Enter New Password** and **Confirm New Password** fields, and then press **enter**.
  - To delete an administrator password, type your current password in the **Enter Password** field, and then press **enter** 4 times.
3. To save your changes and exit Computer Setup, use the arrow keys to select **Exit > Exit Saving Changes**.

Your changes take effect when the computer restarts.

## Entering an administrator password

At the **Enter password** prompt, type your administrator password, and then press **enter**. After 3 unsuccessful attempts to enter the administrator password, you must restart the computer and try again.

## Managing a power-on password

To set, change, or delete this password, follow these steps:

1. Open Computer Setup by turning on or restarting the computer. While the “Press the ESC key for Startup Menu” message is displayed in the lower-left corner of the screen, press **esc**. When the Startup Menu is displayed, press **f10**.
2. Use the arrow keys to select **Security > Set Power-On Password**, and then press **enter**.
  - To set a power-on password, type your password in the **Enter New Password** and **Confirm New Password** fields, and then press **enter**.
  - To change a power-on password, type your current password in the **Enter Current Password** field, type a new password in the **Enter New Password** and **Confirm New Password** fields, and then press **enter**.
  - To delete a power-on password, type your current password in the **Enter Current Password** field, and then press **enter** 4 times.
3. To save your changes and exit Computer Setup, use the arrow keys to select **Exit > Exit Saving Changes**.

Your changes take effect when the computer restarts.

## Entering a power-on password

At the **Enter Password** prompt, type your password, and then press [enter](#). After 3 unsuccessful attempts to enter the password, you must restart the computer and try again.

## Using firewall software

Firewalls are designed to prevent unauthorized access to a system or network. A firewall can be a software program you install on your computer and/or network, or it can be a solution made up of both hardware and software.

There are two types of firewalls to consider:

- Host-based firewalls—Software that protects only the computer it is installed on.
- Network-based firewalls—Installed between your DSL or cable modem and your home network to protect all the computers on the network.

When a firewall is installed on a system, all data sent to and from the system is monitored and compared with a set of user-defined security criteria. Any data that does not meet those criteria is blocked.

Your computer or networking equipment may already have a firewall installed. If not, firewall software solutions are available.

---

 **NOTE:** Under some circumstances a firewall can block access to Internet games, interfere with printer or file sharing on a network, or block authorized e-mail attachments. To temporarily resolve the problem, disable the firewall, perform the task that you want to perform, and then reenable the firewall. To permanently resolve the problem, reconfigure the firewall.

---

1. To view or modify the firewall settings, select **Computer > YaST**.

 **NOTE:** When accessing YaST, you are prompted for the root password.

---

2. In the left pane, click **Security and Users**, and then click **Firewall** in the right pane.

 **NOTE:** When modifying firewall settings, you are prompted for the root password.

---

## Installing an optional security cable

 **NOTE:** A security cable is designed to act as a deterrent, but it may not prevent the computer from being mishandled or stolen.

 **NOTE:** The security cable slot on your computer may look different from the illustration in this section. Refer to [Getting to know your computer on page 3](#) for the location of the security cable slot on your computer.

1. Loop the security cable around a secured object.
2. Insert the key (1) into the cable lock (2).
3. Insert the cable lock into the security cable slot on the computer (3), and then lock the cable lock with the key.

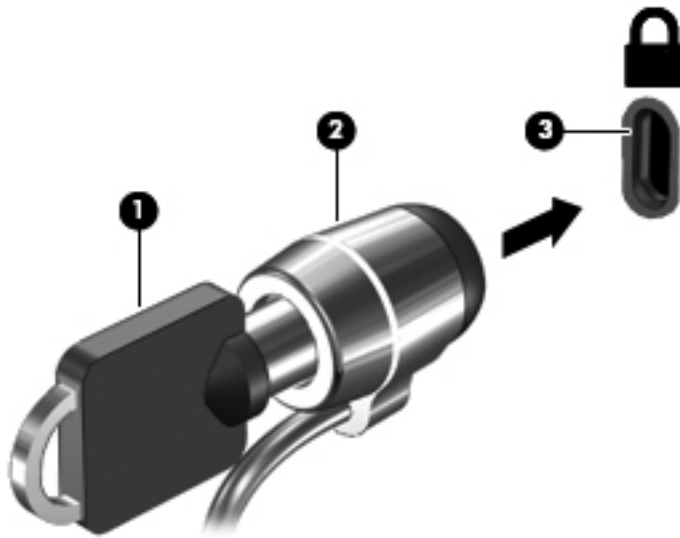

4. Remove the key and keep it in a safe place.

---

# 11 Backup and Recovery

The following sections are included in this chapter:

- [Performing a system recovery](#)
- [Backing up your information](#)

Recovery after a system failure is as good as your most recent backup. As you add new software and data files, you should continue to back up your system on a regular basis to maintain a reasonably current backup.

## Performing a system recovery

Recovery allows you to repair or restore the computer to its original factory state. You can create an HP factory image restore DVD using a DVD±RW optical drive. You can also restore the computer to its factory condition from the HP dedicated recovery partition on the hard drive.

---

 **CAUTION:** Using Recovery completely erases hard drive contents and reformats the hard drive. All files you have created and any software installed on the computer are permanently removed. The recovery tool reinstalls the original operating system and HP programs and drivers that were installed at the factory. Software, drivers, and updates not installed by HP must be manually reinstalled. Personal files must be restored from a backup.

---

To restore the computer using the HP factory image restore DVD, you must first create the recovery disc. To create the recovery disc:

---

 **NOTE:** HP recommends that you create the HP factory image restore DVD in the event of a system failure.

---

1. Select **Computer > More Applications**.
2. In the left pane, click **Tools**, and then click **Create HP Factory Image Restore DVD** in the right pane.
3. Follow the on-screen instructions to create an image file to burn a recovery disc.

To restore the computer from the partition, follow these steps:

1. If possible, back up all personal files.
2. Insert the HP Factory Image Restore DVD into the external optical drive and restart the computer.
3. As the computer is restarting, press **f9** to open the Computer Setup boot option menu.
4. Select the **Notebook Upgrade Bay** option.
5. Using the arrow keys, select **Yes** when prompted: **Do you want to start the System-Restore?**
6. Follow the on-screen instructions.

---

 **NOTE:** You can also restore the computer from the partition by restarting the computer, and then pressing the **f11** key.

---

If you are unable to boot (start up) your computer from the hard drive partition with the primary operating system or from the recovery partition, and you did not create a system recovery disc, you must purchase a *SUSE Linux Enterprise Desktop Operating System* DVD to reinstall the operating system. For additional information, refer to the *Worldwide Telephone Numbers* booklet.

---

# Backing up your information

You should back up your computer files on a regular schedule to maintain a current backup. You can manually back up your information to an optional external drive, a network drive, or discs. Back up your system at the following times:

- At regularly scheduled times
- Before the computer is repaired or restored
- Before you add or modify hardware or software

To back up your home directory files using **Backup Manager Settings**:

1. Select **Computer > More Applications > Tools > Backup Manager Settings**, and then click the **Backup my home directory** button.
2. Click **Storage Destination Location**, and then select a location to back up your information.
3. Click **Schedule**, and then select a time schedule to perform backups at a regularly scheduled time.

To immediately back up your information, click the **Backup Now** check box.

---

 **NOTE:** Before you back up your information, be sure you have designated a location to save the backup files.

---

4. Click the **Save and Backup** button to start the backup and to save the backup settings.

To restore backup files:

1. Select **Computer > More Applications > Tools > Backup Manager Restore**.
2. Click **Backup Source**, and then select the location of the backup files.
3. Click **Restore Destination**, and then select the destination to restore the files.
4. To restore all files from the selected location, click the **Restore all files** button. To restore selective files only, click the **Restore selected files** button, and then click the **Select Files** button and select the files to be restored.
5. Under **Restore Point**, click the time and date of the backup.

---

 **NOTE:** If multiple backups have been performed, click the **Use the latest version** button to restore the latest version.

---

6. Click the **Restore** button to start restoring the files, or click the **Cancel** button to cancel the operation.

---

# 12 Computer Setup (BIOS) and Advanced System Diagnostics

Computer Setup, or Basic Input/Output System (BIOS), controls communication between all the input and output devices on the system (such as disk drives, display, keyboard, mouse, and printer). Computer Setup includes settings for the types of peripherals installed, the startup sequence of the computer, and the amount of system and extended memory.

---

 **NOTE:** Use extreme care when making changes in Computer Setup. Errors can prevent the computer from operating properly.

---

## Starting Computer Setup

---

 **NOTE:** An external keyboard or mouse connected to a USB port can be used with Computer Setup only if USB legacy support is enabled.

---

To start Computer Setup, follow these steps:

1. Turn on or restart the computer, and then press **esc** while the “Press the ESC key for Startup Menu” message is displayed at the bottom of the screen.
2. Press **f10** to enter Computer Setup.

## Using Computer Setup

### Navigating and selecting in Computer Setup

To navigate and select in Computer Setup, follow these steps:

1. Turn on or restart the computer, and then press **esc** while the “Press the ESC key for Startup Menu” message is displayed at the bottom of the screen.
  - To select a menu or a menu item, use the **tab** key and the keyboard arrow keys and then press **enter**, or use a pointing device to click the item.
  - To scroll up and down, click the up arrow or the down arrow in the upper-right corner of the screen, or use the up arrow key or the down arrow key.
  - To close open dialog boxes and return to the main Computer Setup screen, press **esc**, and then follow the on-screen instructions.

---

 **NOTE:** You can use either a pointing device (TouchPad, pointing stick, or USB mouse) or the keyboard to navigate and make selections in Computer Setup.

---

2. Press **f10** to enter Computer Setup.

To exit Computer Setup menus, choose one of the following methods:

- To exit Computer Setup menus without saving your changes, click the **Exit** icon in the lower-left corner of the screen, and then follow the on-screen instructions.

– or –

Use the **tab** key and the arrow keys to select **File > Ignore Changes and Exit**, and then press **enter**.

– or –

- To save your changes and exit Computer Setup menus, click the **Save** icon in the lower-left corner of the screen, and then follow the on-screen instructions.

– or –

Use the **tab** key and the arrow keys to select **File > Save Changes and Exit**, and then press **enter**.

Your changes go into effect when the computer restarts.

## Restoring factory settings in Computer Setup

---

 **NOTE:** Restoring defaults will not change the hard drive mode.

---

To return all settings in Computer Setup to the values that were set at the factory, follow these steps:

1. Turn on or restart the computer, and then press **esc** while the “Press the ESC key for Startup Menu” message is displayed at the bottom of the screen.
2. Press **f10** to enter Computer Setup.
3. Use a pointing device or the arrow keys to select **File > Restore Defaults**.
4. Follow the on-screen instructions.
5. To save your changes and exit, click the **Save** icon in the lower-left corner of the screen, and then follow the on-screen instructions.

– or –

Use the arrow keys to select **File > Save Changes and Exit**, and then press **enter**.

Your changes go into effect when the computer restarts.

---

 **NOTE:** Your password settings and security settings are not changed when you restore the factory settings.

---

## Updating the BIOS

Updated versions of the BIOS may be available on the HP Web site.

Most BIOS updates on the HP Web site are packaged in compressed files called *SoftPaqs*.

Some download packages contain a file named *Readme.txt*, which contains information regarding installing and troubleshooting the file.

## Determining the BIOS version

To determine whether available BIOS updates contain later BIOS versions than those currently installed on the computer, you need to know the version of the system BIOS currently installed.

BIOS version information (also known as *ROM date* and *System BIOS*) can be displayed by starting Computer Setup.

1. Start Computer Setup.
2. Use a pointing device or the arrow keys to select **File > System Information**.
3. To exit Computer Setup without saving your changes, click the **Exit** icon in the lower-left corner of the screen, and then follow the on-screen instructions.

– or –

Use the **tab** key and the arrow keys to select **File > Ignore Changes and Exit**, and then press **enter**.

---

 **NOTE:** You can also determine the BIOS version by turning on or restarting the computer, pressing the **esc** key while the “Press the ESC key for Startup Menu” message is displayed at the bottom of the screen, and then pressing the **f1** key. Follow the on-screen instructions to exit this screen.

---

## Downloading a BIOS update

 **CAUTION:** To reduce the risk of damage to the computer or an unsuccessful installation, download and install a BIOS update only when the computer is connected to reliable external power using the AC adapter. Do not download or install a BIOS update while the computer is running on battery power, docked in an optional docking device, or connected to an optional power source. During the download and installation, follow these instructions:

Do not disconnect power from the computer by unplugging the power cord from the AC outlet.

Do not shut down the computer or initiate Suspend or Hibernation.

Do not insert, remove, connect, or disconnect any device, cable, or cord.

---

1. Open your Web browser, go to <http://www.hp.com/support>, and select your country or region. Access the page on the HP Web site that provides software for your computer. Follow the on-screen instructions to identify your computer and access the BIOS update you want to download.
2. Click the option for software and driver downloads, type your computer model number in the product box, and then press **enter**. Follow the on-screen instructions to identify your computer and access the BIOS update you want to download.
3. Click your specific product from the models listed.

4. Click the appropriate operating system.
5. Go to the BIOS section and download the BIOS software package.
6. Follow the installation instructions as provided with the downloaded BIOS software package.

---

 **NOTE:** After a message on the screen reports a successful installation, you can delete the downloaded file from your hard drive.

---

## Using Advanced System Diagnostics

Advanced System Diagnostics allows you to run diagnostic tests to determine if the computer hardware is functioning properly. The following diagnostic tests are available in Advanced System Diagnostics:

- **Start-up test**—This test analyzes the main computer components that are required to start the computer.
- **Run-in test**—This test repeats the start-up test and checks for intermittent problems that the start-up test does not detect.
- **Hard disk test**—This test analyzes the physical condition of the hard drive, and then checks all data in every sector of the hard drive. If the test detects a damaged sector, it attempts to move the data to a good sector.
- **Memory test**—This test analyzes the physical condition of the memory modules. If it reports an error, replace the memory modules immediately.
- **Battery test**—This test analyzes the condition of the battery and calibrates the battery if necessary. If the battery fails the test, contact HP Customer Support to report the issue and purchase a replacement battery.
- **System Tune-Up**—This group of additional tests checks your computer to make sure that the main components are functioning correctly. System Tune-Up runs longer and more comprehensive tests on memory modules, hard drive SMART attributes, the hard drive surface, the battery (and battery calibration), video memory, and the WLAN module status.

You can view system information and error logs in the Advanced System Diagnostics window.

To start Advanced System Diagnostics:

1. Turn on or restart the computer. While the “Press the ESC key for Startup Menu” message is displayed in the lower-left corner of the screen, press **esc**. When the Startup Menu is displayed, press **f2**.
2. Click the diagnostic test you want to run, and then follow the on-screen instructions.

---

 **NOTE:** If you need to stop a diagnostics test while it is running, press **esc**.

---

---

# 13 MultiBoot

## About the boot device order

As the computer starts, the system attempts to boot from enabled boot devices. The MultiBoot utility, which is enabled at the factory, controls the order in which the system selects a boot device. Boot devices can include optical drives, diskette drives, a network interface card (NIC), hard drives, and USB devices. Boot devices contain bootable media or files that the computer needs to start and operate properly.

---

 **NOTE:** Some boot devices must be enabled in Computer Setup before they can be included in the boot order.

---

The factory setting is for the computer to select the boot device by searching enabled boot devices and drive bay locations in the following order:

---

 **NOTE:** Some of the boot devices and drive bay locations listed may not be supported on your computer.

---

- Notebook upgrade bay
- Optical drive
- Notebook hard drive
- USB diskette drive
- USB CD-ROM
- USB hard drive
- Notebook Ethernet
- Secure Digital (SD) Memory Card
- Docking station upgrade bay
- External SATA drive

You can change the order in which the computer searches for a boot device by changing the boot order in Computer Setup. You can also press **esc** while the “Press the ESC key for Startup Menu” message is displayed at the bottom of the screen, and then press **f9**. Pressing **f9** displays a menu that shows the current boot devices and allows you to select a boot device. Or, you can use MultiBoot Express to set the computer to prompt you for a boot location each time the computer turns on or restarts.

# Enabling boot devices in Computer Setup

The computer will boot to a USB device or a NIC device only if the device has first been enabled in Computer Setup.

To start Computer Setup and enable a USB device or a NIC device as a boot device, follow these steps:

1. Turn on or restart the computer, and then press **esc** while the “Press the ESC key for Startup Menu” message is displayed at the bottom of the screen.
2. Press **f10** to enter Computer Setup.
3. To enable bootable media in USB drives or in drives inserted into an optional docking device (select models only), use a pointing device or the arrow keys to select **System Configuration > Device Configurations**. Confirm **USB legacy support** is selected.

---

 **NOTE:** The USB Port option must be enabled in order to use USB legacy support. It is enabled at the factory. If the port becomes disabled, reenable it by selecting **System Configuration > Port Options**, and then selecting **USB Port**.

---

– or –

To enable a NIC device, select **System Configuration > Boot Options**, and then select **PXE Internal NIC boot**.

4. To save your changes and exit Computer Setup, click the **Save** icon in the lower-left corner of the screen, and then follow the on-screen instructions.

– or –

Use the arrow keys to select **File > Save Changes and Exit**, and then press **enter**.

Your changes go into effect when the computer restarts.

---

 **NOTE:** To connect a NIC to a Preboot eXecution Environment (PXE) or Remote Program Load (RPL) server without using MultiBoot, press **esc** while the “Press the ESC key for Startup Menu” message is displayed at the bottom of the screen, and then quickly press **f12**.

---

## Considering boot order changes

Before changing the boot order, note the following considerations:

- When the computer restarts after the boot order has been changed, the computer attempts to start using the new boot order.
- If there is more than one type of boot device, the computer attempts to boot using the first device of each type of boot device (except for optical devices). For example, if the computer is connected to an optional docking device (select models only) that contains a hard drive, this hard drive will be shown in the boot order as a USB hard drive. If the system attempts to boot from this USB hard drive and fails, it will not attempt to boot to the hard drive in the hard drive bay. Instead, it will try to boot to the next type of device in the boot order. However, if there are two optical devices, and the first optical device does not boot (either because it does not contain media or the media is not a boot disc), the system will try to boot to the second optical device.
- Changing the boot order also changes the logical drive designations. For example, if you start up from a CD-ROM drive with a disc formatted as drive C, that CD-ROM drive becomes drive C and the hard drive in the hard drive bay becomes drive D.
- The computer will boot from a NIC device only if the device has been enabled in the Built-In Device Options menu of Computer Setup and if booting from the device has been enabled in the Boot Options menu of Computer Setup. Booting from a NIC does not affect logical drive designations because no drive letter is associated with the NIC.
- Drives in an optional docking device (select models only) are treated like external USB devices in the boot order.

# Choosing MultiBoot preferences

You can use MultiBoot in the following ways:

- To set a new boot order that the computer uses each time it is turned on, by changing the boot order in Computer Setup.
- To dynamically choose the boot device, by pressing **esc** while the “Press the ESC key for Startup Menu” message is displayed at the bottom of the screen, and then pressing **f9** to enter the Boot Device Options menu.
- To use MultiBoot Express to set variable boot orders. This feature prompts you for a boot device each time the computer is turned on or restarted.

## Setting a new boot order in Computer Setup

To start Computer Setup and set a boot device order that the computer uses each time it is turned on or restarted, follow these steps:

1. Turn on or restart the computer, and then press **esc** while the “Press the ESC key for Startup Menu” message is displayed at the bottom of the screen.
2. Press **f10** to enter Computer Setup.
3. Use a pointing device or the arrow keys to select the **Legacy Boot Order** list, and then press **enter**.
4. To move the device up in the boot order, use a pointing device to click the up arrow, or press the **+** key.  
– or –  
To move the device down in the boot order, use a pointing device to click the down arrow, or press the **-** key.
5. To save your changes and exit Computer Setup, click the **Save** icon in the lower-left corner of the screen, and then follow the on-screen instructions.

– or –

Use the arrow keys to select **File > Save Changes and Exit**, and then press **enter**.

Your changes go into effect when the computer restarts.

## Dynamically choosing a boot device using the f9 prompt

To dynamically choose a boot device for the current startup sequence, follow these steps:

1. Open the Select Boot Device menu by turning on or restarting the computer, and then pressing **esc** while the “Press the ESC key for Startup Menu” message is displayed at the bottom of the screen.
2. Press **f9**.
3. Use a pointing device or the arrow keys to select a boot device, and then press **enter**.

Your changes go into effect immediately.

## Setting a MultiBoot Express prompt

To start Computer Setup and set the computer to display the MultiBoot startup location menu each time the computer is started or restarted, follow these steps:

1. Turn on or restart the computer, and then press **esc** while the “Press the ESC key for Startup Menu” message is displayed at the bottom of the screen.
2. Press **f10** to enter Computer Setup.
3. Use a pointing device or the arrow keys to select **System Configuration > Boot Options**, and then press **enter**.
4. In the **Multiboot Express Popup Delay (Sec)** field, enter the length of time in seconds that you want the computer to display the startup location menu before it defaults to the current MultiBoot setting. (When 0 is selected, the Express Boot startup location menu is not displayed.)
5. To save your changes and exit Computer Setup, click the **Save** icon in the lower-left corner of the screen, and then follow the on-screen instructions.

– or –

Use the arrow keys to select **File > Save Changes and Exit**, and then press **enter**.

Your changes go into effect when the computer restarts.

## Entering MultiBoot Express preferences

When the Express Boot menu is displayed during startup, you have the following choices:

- To specify a boot device from the Express Boot menu, select your preference within the allotted time, and then press **enter**.
- To prevent the computer from defaulting to the current MultiBoot setting, press any key before the allotted time expires. The computer will not start until you select a boot device and press **enter**.
- To allow the computer to start according to the current MultiBoot settings, wait for the allotted time to expire.

---

# A Troubleshooting and support

The following sections are included in this appendix:

- [Troubleshooting](#)
- [The process of burning a disc does not begin, or it stops before completion](#)
- [Contacting customer support](#)
- [Labels](#)

## Troubleshooting

The following sections describe several common issues and solutions.

### The computer is unable to start up

If the computer does not turn on when you press the power button, the following suggestions may help you determine why the computer does not start up:

- If the computer is plugged into an AC outlet, plug another electrical device into the outlet to be sure that the outlet is providing adequate power.



**NOTE:** Use only the AC adapter provided with the computer or one approved by HP for this computer.

- If the computer is plugged into an external power source other than an AC outlet, plug the computer into an AC outlet using the AC adapter. Be sure that the power cord and AC adapter connections are secure.

### The computer screen is blank

If the screen is blank but you have not turned off the computer, one or more of these settings may be the cause:

- The computer may be in the Suspend state or in Hibernation. To exit Suspend or Hibernation, briefly press the power button. Suspend and Hibernation are energy-saving features that turn off the display. Suspend and Hibernation can be initiated by the system while the computer is on but is not in use, or when the computer has reached a low battery level. To change these and other power settings, right-click the **Battery** icon in the notification area, at the far right of the taskbar, and then click **Preferences**.
- The computer may not be set to display the image on the computer screen. To transfer the image to the computer screen, press **fn+f4**. On most models, when an optional external display, such as a monitor, is connected to the computer, the image can be displayed on the computer

screen or the external display, or on both devices simultaneously. When you press [fn+f4](#) repeatedly, the image alternates among the computer display, one or more external displays, and simultaneous display on all devices.

## Software is functioning abnormally

If the software is unresponsive or responds abnormally, restart the computer by selecting **Computer > Shutdown > Restart**. If you cannot restart the computer using this procedure, refer to the next section, [The computer is on but not responding on page 90](#).

## The computer is on but not responding

If the computer is turned on but is not responding to software or keyboard commands, try the following emergency shutdown procedures, in the sequence provided, until shutdown occurs:

---

 **CAUTION:** Emergency shutdown procedures result in the loss of unsaved information.

---

- Press and hold the power button for at least 5 seconds.
- Disconnect the computer from external power and remove the battery.

## The computer is unusually warm

It is normal for the computer to feel warm to the touch while it is in use. But if the computer feels *unusually* warm, it may be overheating because a vent is blocked.

If you suspect that the computer is overheating, allow the computer to cool to room temperature. Be sure to keep all vents free from obstructions while you are using the computer.

---

 **WARNING!** To reduce the possibility of heat-related injuries or of overheating the computer, do not place the computer directly on your lap or obstruct the computer air vents. Use the computer only on a hard, flat surface. Do not allow another hard surface, such as an adjoining optional printer, or a soft surface, such as pillows or rugs or clothing, to block airflow. Also, do not allow the AC adapter to contact the skin or a soft surface, such as pillows or rugs or clothing, during operation. The computer and the AC adapter comply with the user-accessible surface temperature limits defined by the International Standard for Safety of Information Technology Equipment (IEC 60950).

---

 **NOTE:** The fan in the computer starts up automatically to cool internal components and prevent overheating. It is normal for the internal fan to cycle on and off during operation.

---

## An external device is not working

Follow these suggestions if an external device does not function as expected:

- Turn on the device according to the manufacturer's instructions.
- Be sure that all device connections are secure.
- Be sure that the device is receiving electrical power.
- Be sure that the device, especially if it is older, is compatible with the operating system.
- Be sure that the correct drivers are installed and updated.

## The wireless network connection is not working

If a wireless network connection is not working as expected, follow these suggestions:

- To enable or disable a wireless or wired network device, right-click the **Network Connection** icon in the notification area, at the far right of the taskbar. To enable devices, select the check box from the menu option. To disable the device, clear the check box.
- Be sure that the wireless device is turned on.
- Be sure that the computer wireless antennas are free from obstructions.
- Be sure that the cable or DSL modem and its power cord are properly connected and that the lights are on.
- Be sure that the wireless router or access point is properly connected to its power adapter and to the cable or DSL modem, and that the lights are on.
- Disconnect and then reconnect all cables, and turn the power off and then back on.

## The optical disc tray does not open for removal of a CD or DVD

1. Insert the end of a paper clip (1) into the release access in the front bezel of the drive.
2. Press in gently on the paper clip until the disc tray is released, and then pull out the tray (2) until it stops.
3. Remove the disc (3) from the tray by gently pressing down on the spindle while lifting the outer edges of the disc. Hold the disc by the edges and avoid touching the flat surfaces.

---

 **NOTE:** If the tray is not fully accessible, tilt the disc carefully as you remove it.

---

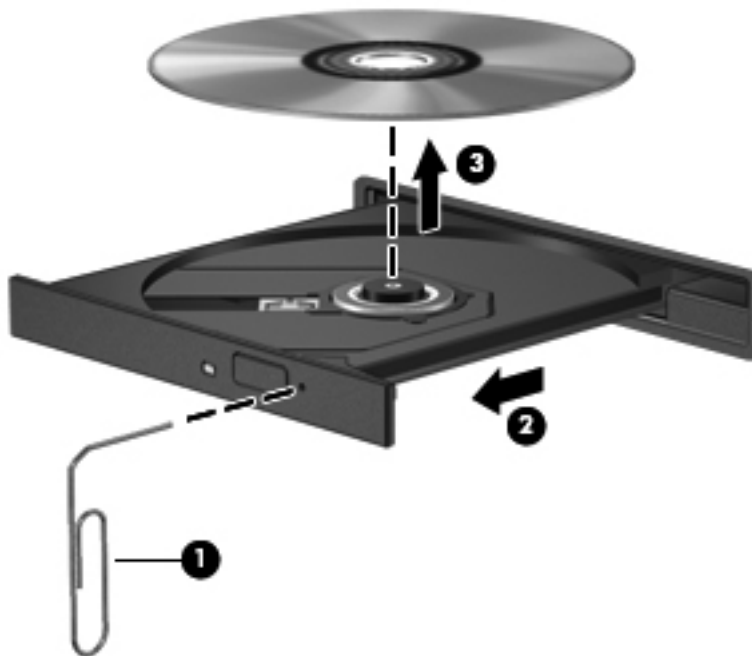

4. Close the disc tray and place the disc in a protective case.

## The computer does not detect the optical drive

If your operating system does not detect an installed device, the device driver software may be missing or corrupted.

1. Remove any discs from the optical drive.
2. Click **Computer** and then click **System Monitor**.
3. On the **Hardware** tab, identify the Storage Controller in the **Type** column.
4. Click the triangle next to the devices until you locate your optical drive. If the drive is listed, it should be functioning correctly.

## A disc does not play

- Save your work and close all open programs before playing a CD or a DVD.
- Log off the Internet before playing a CD or a DVD.
- Be sure that you insert the disc properly.
- Be sure that the disc is clean. If necessary, clean the disc with filtered water and a lint-free cloth. Wipe from the center of the disc to the outer edge.
- Check the disc for scratches. If you find scratches, treat the disc with an optical disc repair kit available at many electronics stores.
- Disable Suspend mode before playing the disc.

Do not initiate Hibernation or Suspend while playing a disc. Otherwise, you may see a warning message asking if you want to continue. If this message is displayed, click **No**. After you click No, the computer may behave in either of the following ways:

- Playback may resume.
- or –
- The playback window in the multimedia program may close. To return to playing the disc, click the **Play** button in your multimedia program to restart the disc. In rare cases, you may need to exit the program and then restart it.

## A movie is not visible on an external display

1. If both the computer display and an external display are turned on, press **fn+f4** one or more times to switch between the 2 displays.
2. Configure the monitor settings to make the external display primary:
  - a. Right-click on a blank area of the computer desktop, and select **Screen resolution**.
  - b. Specify a primary display and a secondary display.



**NOTE:** When using both displays, the DVD image will not appear on any display designated as the secondary display.

## The process of burning a disc does not begin, or it stops before completion

- Be sure that all other programs are closed.
- Turn off Suspend mode and Hibernation.
- Be sure that you are using the right kind of disc for your drive.
- Be sure that the disc is inserted properly.
- Select a slower write speed and try again.
- If you are copying a disc, save the information on the source disc to your hard drive before trying to burn the contents to a new disc, and then burn from your hard drive.

## Contacting customer support

If the information provided in this guide does not address your questions, you can contact HP Customer Support at:

<http://www.hp.com/go/contactHP>



---

**NOTE:** For worldwide support, click **Contact HP worldwide** on the left side of the page, or go to [http://welcome.hp.com/country/us/en/wwcontact\\_us.html](http://welcome.hp.com/country/us/en/wwcontact_us.html).

---

Here you can:

- Chat online with an HP technician.



---

**NOTE:** When technical support chat is not available in a particular language, it is available in English.

---

- E-mail HP Customer Support.
- Find HP Customer Support worldwide telephone numbers.
- Locate an HP service center.

# Labels

The labels affixed to the computer provide information you may need when you troubleshoot system problems or travel internationally with the computer:

- Serial number label—Provides important information, including the following:

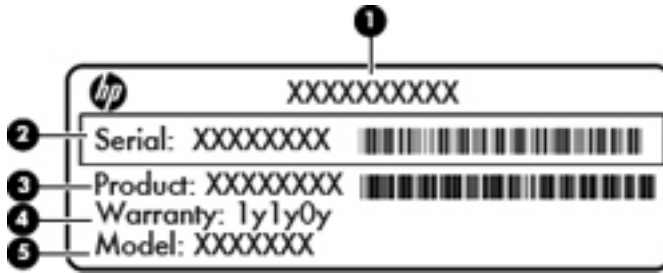

Component	
(1)	Product name
(2)	Serial number (s/n)
(3)	Part number/product number (p/n)
(4)	Warranty period
(5)	Model description

Have this information available when you contact technical support. The serial number label is affixed inside the battery bay.

- Regulatory label—Provides regulatory information about the computer. The regulatory label is located underneath the bottom cover of the computer or inside the battery bay.
- Wireless certification label or labels (select models only)—Provide information about optional wireless devices and the approval markings of some of the countries or regions in which the devices have been approved for use. If your computer model includes one or more wireless devices, one or more certification labels are included with your computer. You may need this information when traveling internationally. Wireless certification labels are located on the bottom cover of the computer or inside the battery bay.
- SIM (subscriber identity module) label (select models only)—Provides the ICCID (Integrated Circuit Card Identifier) of the SIM. This label is located inside the battery bay.
- HP Mobile Broadband Module serial number label (select models only)—Provides the serial number of the HP Mobile Broadband Module. This label is located inside the battery bay.

---

## B Cleaning your computer

- [Cleaning products](#)

### Cleaning products

Use the following products to safely clean and disinfect your computer:

- Dimethyl benzyl ammonium chloride 0.3 percent maximum concentration (For example: germicidal disposable wipes. These wipes come in a variety of brand names.)
- Alcohol-free glass cleaning fluid
- Water with mild soap solution
- Dry microfiber cleaning cloth or a chamois (static-free cloth without oil)
- Static-free cloth wipes

---

 **CAUTION:** Avoid the following cleaning products:

Strong solvents, such as alcohol, acetone, ammonium chloride, methylene chloride, and hydrocarbons, which can permanently damage the surface of the compute.

Fibrous materials, such as paper towels, which can scratch the computer. Over time, dirt particles and cleaning agents can get trapped in the scratches.

---

---

# C Specifications

The following sections are included in this appendix:

- [Input power](#)
- [Operating environment](#)

## Input power

The power information in this section may be helpful if you plan to travel internationally with the computer.

The computer operates on DC power, which can be supplied by an AC or a DC power source. The AC power source must be rated at 100–240 V, 50–60 Hz. Although the computer can be powered from a standalone DC power source, it should be powered only with an AC adapter or a DC power source supplied and approved by HP for use with this computer.

The computer can operate on DC power within the following specifications.

Input Power	Rating
Operating voltage and current	19.0 V dc @ 4.74 A - 90 W

 **NOTE:** This product is designed for IT power systems in Norway with phase-to-phase voltage not exceeding 265 V rms.

 **NOTE:** The computer operating voltage and current can be found on the system regulatory label inside the battery bay.

# Operating environment

<b>Factor</b>	<b>Metric</b>	<b>U.S.</b>
<b>Temperature</b>		
Operating (writing to optical disc)	<b>5°C to 35°C</b>	41°F to 95°F
Nonoperating	<b>-20°C to 60°C</b>	-4°F to 140°F
<b>Relative humidity</b> (noncondensing)		
Operating	<b>10% to 90%</b>	10% to 90%
Nonoperating	<b>5% to 95%</b>	5% to 95%
<b>Maximum altitude</b> (unpressurized)		
Operating	<b>-15 m to 3,048 m</b>	-50 ft to 10,000 ft
Nonoperating	<b>-15 m to 12,192 m</b>	-50 ft to 40,000 ft

---

## D Electrostatic discharge

Electrostatic discharge is the release of static electricity when two objects come into contact—for example, the shock you receive when you walk across the carpet and touch a metal door knob.

A discharge of static electricity from fingers or other electrostatic conductors may damage electronic components. To prevent damage to the computer, damage to a drive, or loss of information, observe these precautions:

- If removal or installation instructions direct you to unplug the computer, unplug it after being properly grounded and before removing a cover.
- Keep components in their electrostatic-safe containers until you are ready to install them.
- Avoid touching pins, leads, and circuitry. Handle electronic components as little as possible.
- Use nonmagnetic tools.
- Before handling components, discharge static electricity by touching an unpainted metal surface of the component.
- If you remove a component, place it in an electrostatic-safe container.

If you need more information about static electricity or assistance with component removal or installation, contact Customer Support.

---

# Index

## Symbols/Numerics

- 1394 cable, connecting 65
- 1394 devices
  - connecting 65
  - defined 65
  - removing 65
- 1394 port, identifying 11

## A

- accessory battery connector, identifying 14
- administrator password
  - creating 74
  - entering 74
  - managing 74
- airport security devices 46
- audio features 30
- audio functions, checking 31
- audio-in (microphone) jack 10
- audio-out (headphone) jack 10

## B

- backup 77
- battery
  - charging 40
  - conserving power 42
  - disposing 43
  - inserting 39
  - life 41
  - low battery levels 41
  - power 38
  - removing 39
  - storing 42
  - temperature 42
- battery bay 14, 94
- battery light 9
- battery release latch 13, 39
- BIOS
  - determining version 82

- downloading an update 82
- updating 82
- Bluetooth compartment, identifying 14
- Bluetooth device 20
- Bluetooth label 94
- boot devices, enabling 85
- bottom cover
  - regulatory label 94
- Bottom cover release latch, identifying 14
- bottom cover, removing or replacing 46
- buttons
  - left pointing stick 4
  - left TouchPad 4
  - optical drive eject 11
  - power 6
  - QuickWeb 6
  - right pointing stick 4
  - right TouchPad 4
  - TouchPad on/off 4, 6
  - volume 31
  - volume mute 7
  - wireless 6

## C

- cables
  - 1394 65
  - eSATA 66
  - LAN 22
  - USB 64
- caps lock light, identifying 5
- changing boot order 87
- charging batteries 40
- checking audio functions 31
- cleaning your computer 95
- components
  - bottom 13

- display 12
  - front 9
  - left side 11
  - rear 13
  - right side 10
  - top 4
- Computer Setup
  - enabling bootable devices 85
  - navigating and selecting 80
  - passwords set in 73
  - restoring factory settings 81
  - setting boot order 87
  - setting MultiBoot Express prompt 88
- configuring ExpressCards 61
- connecting to a WLAN 17
- connector, docking 13, 68
- connector, power 11
- conservation, power 42
- corporate WLAN connection 17
- critical battery level 41

## D

- display image, switching 24
- display release latch 9
- DisplayPort, connecting 34
- DisplayPort, identifying 10
- docking connector 68
- docking connector, identifying 13
- drive media 36
- drives
  - boot order 84
  - external 67
  - handling 45
  - hard 67
  - optical 67

## E

- electrostatic discharge 99

- Embedded numeric keypad,
    - identifying 8
  - embedded numeric keypad,
    - identifying 24
  - entering a power-on password 75
  - entering an administrator
    - password 74
  - eSATA cable, connecting 66
  - eSATA devices
    - connecting 66
    - defined 66
    - removing 66
  - eSATA port, identifying 10
  - ExpressCard
    - configuring 61
    - defined 61
    - inserting 62
    - removing 63
    - removing insert 62
  - ExpressCard slot 11
  - external devices 67
  - external drive 67
  - external monitor port 13, 32
- F**
- fingerprint reader
    - identifying 7
    - using 29
  - firewall 19
  - fn key, identifying 8, 23
  - function keys
    - identifying 8
- H**
- hard drive
    - external 67
    - installing 49
    - removing 49
  - hard drive light 9
  - Hibernation
    - exiting 37
    - initiated during critical battery level 41
    - initiating 37
  - hotkeys
    - adjusting volume 24
    - battery charge 24
    - decrease screen brightness 24
    - description 23
    - increase screen brightness 24
    - Suspend 24
    - switching screen image 24
    - using 23
  - hubs 63
- I**
- icons
    - network 16
    - wired network 16
    - wireless 16
  - input power 97
  - integrated webcam light,
    - identifying 12
  - internal display switch 12
  - internal microphones, identifying 12
  - Internet connection setup 18
  - issues, resolving 89
- J**
- jacks
    - audio-in (microphone) 10
    - audio-out (headphone) 10
    - network 13
    - RJ-11 (modem) 13
    - RJ-45 (network) 13
- K**
- keypad
    - 24
  - keypad, embedded numeric 8
  - keys
    - fn 8
    - function 8
    - num lk 8
    - operating system
      - applications 8
    - operating system logo 8
    - volume 31
- L**
- labels
    - Bluetooth 94
    - HP Mobile Broadband Module 94
    - regulatory 94
    - serial number 94
    - SIM 94
    - wireless certification 94
    - WLAN 94
  - latch, battery release 13
  - latch, bottom cover release 14
  - legacy support, USB 80
  - lights
    - battery 9
    - caps lock 5
    - hard drive 9
    - mute 5
    - num lock 5
    - power 5, 9
    - QuickWeb 5
    - webcam 12
    - wireless 5, 9
  - local area network (LAN)
    - cable required 22
    - connecting cable 22
  - logical drive designations 86
  - low battery level 41
- M**
- managing a power-on password 74
  - managing an administrator
    - password 74
  - media card
    - defined 59
    - inserting 59
    - removing 60
    - stopping 60
  - Media Card Reader, identifying 11
  - memory module
    - inserting 70
    - removing 69
  - memory module compartment,
    - identifying 14
  - Mobile Broadband Module,
    - identifying 14
  - mouse, external
    - setting preferences 28
  - MultiBoot Express 84, 88
  - mute light, identifying 5
- N**
- network cable
    - 22
    - connecting 22
    - noise suppression circuitry 22
  - network connection icons 16

- network jack, identifying 13
  - Network Service Boot 85
  - NIC boot device 84, 85
  - noise suppression circuitry
    - network cable 22
  - num lk key, identifying 8, 25
  - num lock light 5
- O**
- operating environment 98
  - operating system 35
  - operating system applications
    - key 8
  - operating system logo key 8
  - operating system, passwords set
    - in 73
  - optical disc
    - inserting 55
    - removing 56
  - optical drive 67
  - optical drive eject button,
    - identifying 11
  - optical drive, identifying 11
  - optional external devices, using 67
  - optional security cable 76
- P**
- passwords
    - set in Computer Setup 73
    - set in operating system 73
  - pinching TouchPad gesture 28
  - pointing stick 4
  - ports
    - 1394 11
    - DisplayPort 10, 34
    - eSATA 10
    - external monitor 13, 32
    - USB 10, 11, 63
    - VGA 32
  - power button, identifying 6
  - power connector, identifying 11
  - power light 5, 9
  - power, conserving 42
  - power-on password
    - creating 74
    - entering 75
    - managing 74
  - product name and number,
    - computer 94
  - public WLAN connection 17
  - PXE server 85
- Q**
- QuickWeb
    - light 5
  - QuickWeb button
    - identifying 6
- R**
- readable media 36
  - recovery 77
  - regulatory information
    - regulatory label 94
    - wireless certification labels 94
  - RJ-11 (modem) jack, identifying 13
  - RJ-45 (network) jack, identifying 13
- S**
- screen brightness keys 24
  - screen image, switching 24
  - scrolling TouchPad gesture 28
  - security cable 76
  - security cable slot, identifying 10
  - security, wireless 19
  - serial number, computer 94
  - setup of WLAN 18
  - shutdown 35
  - slot-load optical drive 56
  - slots
    - ExpressCard 11
    - security cable 10
  - smart card reader 11
  - speakers, identifying 9
  - storing battery 42
  - Suspend
    - exiting 36
    - initiating 36
- T**
- temperature 42
  - TouchPad
    - buttons 4
    - setting preferences 28
  - TouchPad gestures
    - pinching 28
    - scrolling 28
    - zooming 28
  - TouchPad on/off button 4, 6
  - TouchPad, identifying 4
  - traveling with the computer 42, 94
  - tray-load optical drive 55
  - troubleshooting
    - disc burning 93
    - disc play 92
    - optical disc tray 91
    - optical drive detection 92
  - troubleshooting, external display 92
  - turning off the computer 35
- U**
- unresponsive system 35
  - upgrade bay
    - replacing a hard drive 50
    - replacing an optical drive 53
  - upgrade bay, identifying 11
  - USB cable, connecting 64
  - USB devices
    - connecting 64
    - description 63
    - removing 64
  - USB hubs 63
  - USB legacy support 80
  - USB ports, identifying 10, 11, 63
- V**
- vents, identifying 10, 14
  - VGA port, connecting 32
  - video, using 32
  - volume
    - adjusting 31
    - buttons 31
    - keys 31
  - volume keys, identifying 24
  - volume mute button, identifying 7
- W**
- webcam 12
    - using 32
  - webcam light, identifying 12
  - webcam, identifying 12
  - wireless button
    - using 16
  - wireless button, identifying 6
  - wireless certification label 94
  - wireless devices, types 16
  - wireless encryption 19
  - wireless icon 16

- wireless light 16
- wireless lights 5, 9
- wireless network (WLAN) 22
  - connecting 17
  - corporate WLAN connection 17
  - described 16
  - equipment needed 18
  - public WLAN connection 17
  - security 19
- wireless, identifying 14
- WLAN antennas, identifying 12
- WLAN device 94
- WLAN label 94
- writable media 36

## Z

- zooming TouchPad gesture 28

