

For more support, contact us via www.mova-tech.com
Manufactured by: XingKuang Innovation Technology (Suzhou) Co., Ltd.
Made in China



EU-A00

MOVA V50 Ultra

Robot Vacuum and Mop with
Auto-Empty and Mop Self-Cleaning
User Manual

The illustrations in this manual are for reference only. Please refer to the actual product.



MOVA

Safety Information

To avoid electric shock, fire or injury caused by improper use of the appliance, please read the user manual carefully before using the appliance and keep it for future reference.

Usage Restrictions

- This product should not be used by children younger than 8 years old nor persons with physical, sensory, intellectual deficiencies, or limited experience or knowledge without the supervision of a parent or guardian to ensure safe operation and to avoid any risks. Cleaning and maintenance shall not be performed by children without supervision.
- The appliance is only to be used with the power supply unit provided with the appliance.
- This appliance contains batteries that are only replaceable by skilled persons.
- Clear the area to be cleaned. Children shall not play with the appliance. Ensure children and pets are kept at a safe distance from the robot while it is operating.
- Do not install, charge or use the appliance in the bathrooms or around the pools.
- This product is for floor cleaning in a home environment only. Do not use it outdoors, on non-floor surfaces, or in a commercial or industrial setting.
- Ensure that the appliance operates correctly in a proper environment. Otherwise, do not use the appliance.
- If the power cord is damaged, it must be replaced by a special cord or assembly available from the manufacturer or its service agent.

Safety Information

Usage Restrictions

- Do not use the robot in an area suspended above ground level without a protective barrier.
- Do not place the robot upside down. Do not use the LDS cover, robot cover, or bumper as a handle for the robot.
- Use the robot in environments with an ambient temperature above 0°C and below 40°C. Make sure there is no liquid or sticky substance on the floor.
- To prevent damage or harm from dragging, clear any loose objects from the floor, and remove cables or power cords on the cleaning path before operating the appliance.
- Remove fragile or small items from the floor to prevent the robot from bumping into and damaging them.
- Keep hair, fingers, and other body parts away from the suction opening of the robot.
- Keep the cleaning tool out of reach of children.
- Do not operate the appliance in a room where an infant or child is sleeping.
- Do not place children, pets, or any item on top of the robot regardless of whether it is stationary or moving.
- Only clean water and the officially-approved cleaning solution can be added to the clean water tank. Do not add any other liquid such as alcohol or disinfectant. The ratio of the cleaning solution to clean water can be checked on the cleaning solution bottle. Keep the cleaning solution out of reach of children.

Safety Information

Usage Restrictions

- Do not use the robot to clean any burning objects. Do not use the robot to pick up flammable or combustible liquids, corrosive gases, or undiluted acids or solvents.
- Do not vacuum hard or sharp objects. Do not use the appliance to pick up objects such as stones, large pieces of paper or any item that may clog the appliance.
- Plug must be removed from the socket-outlet before cleaning or maintaining the appliance.
- Do not wipe the robot or the base station with a wet cloth or rinse them with any liquid. After cleaning washable parts, fully dry the parts before reinstalling and using them.
- Please use this product in accordance with the instructions in the User Manual. Users are responsible for any loss or damage that arise from improper use of this product.

Batteries and Charging

- Do not use any third-party battery or base station. The robot can only be used with the model RCVE0202 base station.
- Do not attempt to disassemble, repair, or modify the battery or the base station on your own.
- Do not place the base station near a heat source.
- Do not use a wet cloth or wet hands to wipe or clean the base station's charging contacts.

Batteries and Charging

- Do not improperly dispose of old batteries. Unneeded batteries should be discarded at an appropriate recycling facility.
- If the power cord becomes damaged or broken, stop using it immediately and contact after-sales service.
- Make sure the robot is turned off when being transported and kept in its original packaging if possible.
- If the robot will not be used for an extended period of time, fully charge it, then turn it off and store it in a cool, dry place. Recharge the robot at least once every 3 months to avoid over-discharging the battery.

Laser Safety Information

- The laser sensor in this product meets the IEC 60825-1:2014/EN 60825-1:2014/A11:2021 Standard for Class 1 laser products. Please avoid direct eye contact with it during use.

CLASS 1 LASER PRODUCT
 CONSUMER LASER PRODUCT
 EN 50689:2021

 For indoor use only

 Read operator's manual

Hereby, XingKuang Innovation Technology (Suzhou) Co., Ltd. declares that the radio equipment type RLV72LE is in compliance with Directive 2014/53/EU.

The full text of the EU declaration of conformity is available at the following internet address: www.mova-tech.com

For detailed e-manual, please go to <https://www.mova-tech.com/pages/user-manuals-and-faqs>

Product Overview

Package Contents

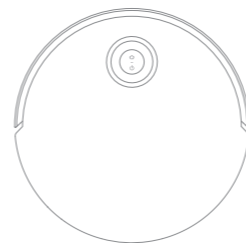

Robot

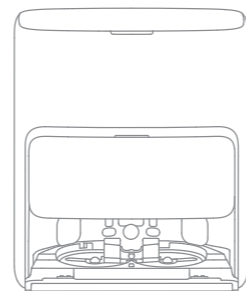

Base Station

Other Accessories

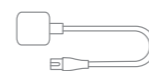

Power Cord



Base Station Ramp Extension Plate



User Manual



Auto Solution Dispenser Module - Dual Compartment (pre-installed)



Dust Bag × 2 (1 pre-installed)

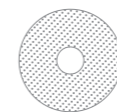

Mop Pad × 2 (pre-installed)



Mop Pad Holder × 2



Washboard Filter (pre-installed)



Cleaning Solution



Pet Odor Solution

Product Overview

Robot

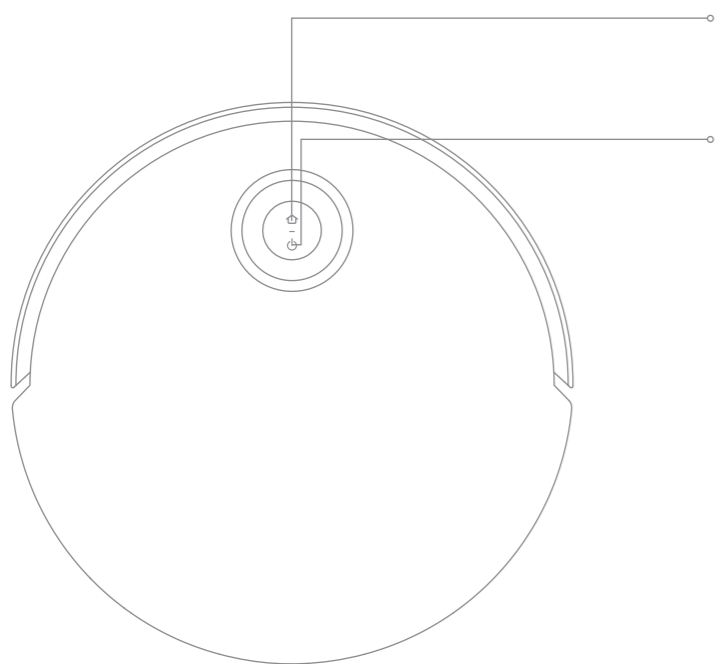

🏠 Dock Button

- Press to send the robot back to the base station
- Press and hold for 3 seconds to disable Child Lock

🔌 Power / Clean Button

- Press and hold for 3 seconds to turn on or off
- Press to start cleaning after the robot is turned on

Button Status Indicator

- Solid White: Cleaning or cleanup completed
- Breathing White: Charging (not low battery)
- Solid Orange: Standby at low battery or paused at low battery
- Breathing Orange: Charging (low battery)
- Blinking Orange: Error

Note:

- Press any button on the robot to pause while the robot is cleaning or returning to charge.
- Child Lock can be enabled/disabled through the MOVAhome App.

Product Overview

Robot and Sensors

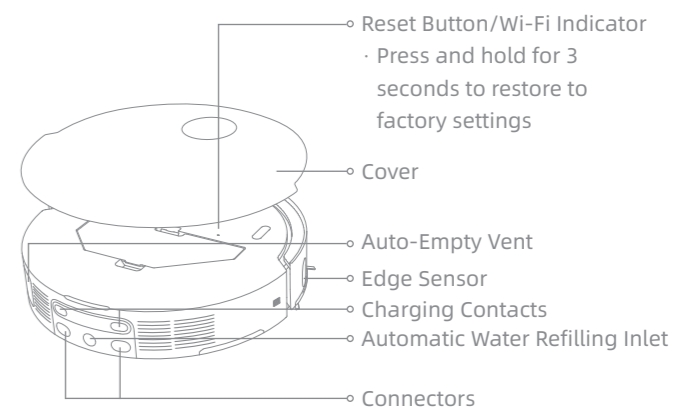
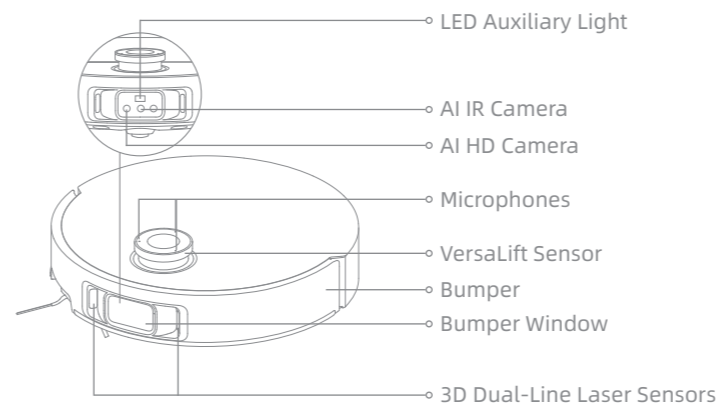

Note: The VersaLift sensor will be lowered when the robot is in standby mode, charging on the base station, or cleaning low-clearance areas. In the case of cleaning low-clearance areas, do not move the robot as it may affect its positioning.

Product Overview

Robot and Sensors

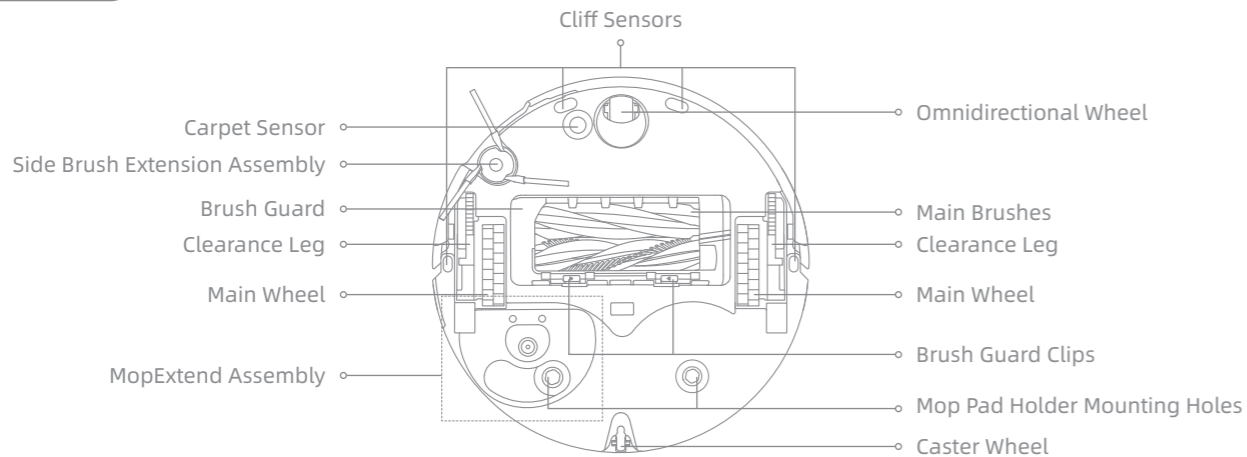

Dust Box

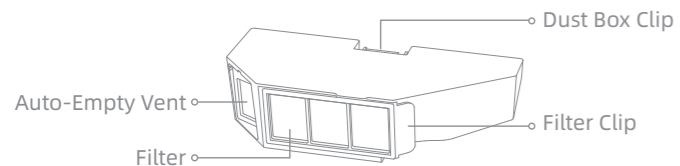

Mop Assembly

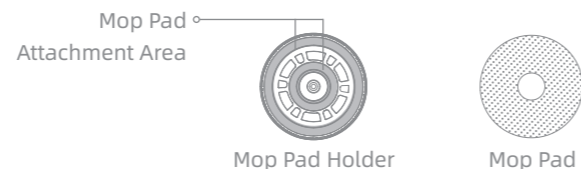

Product Overview

Base Station

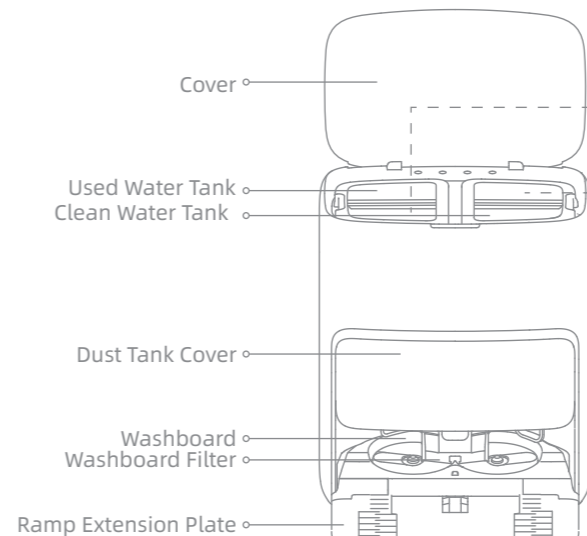

Used Water Tank

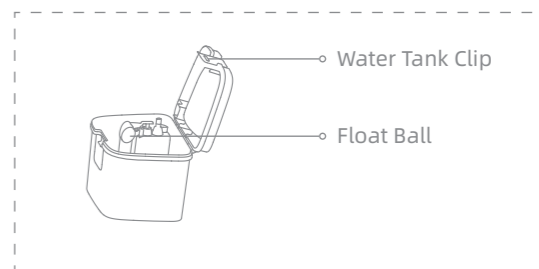

Clean Water Tank

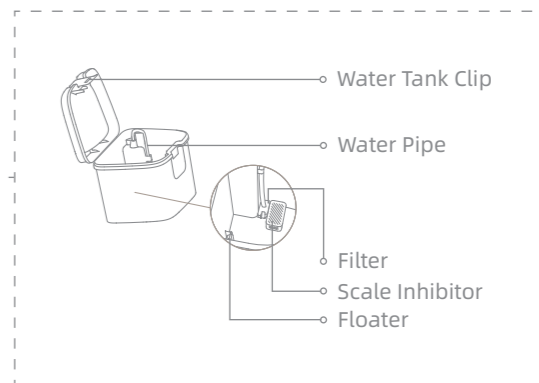

Product Overview

Base Station

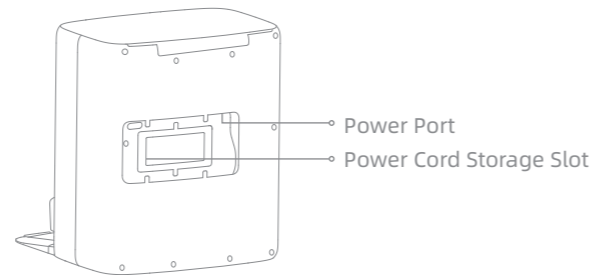
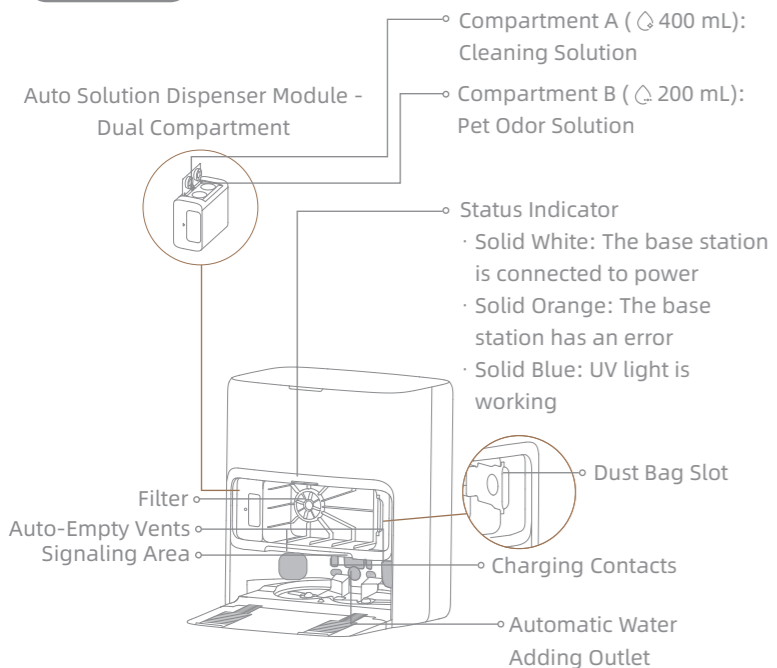

Note: The dual compartment can be replaced with a single compartment to add more cleaning solution. If needed, please purchase separately.

Preparing Your Home

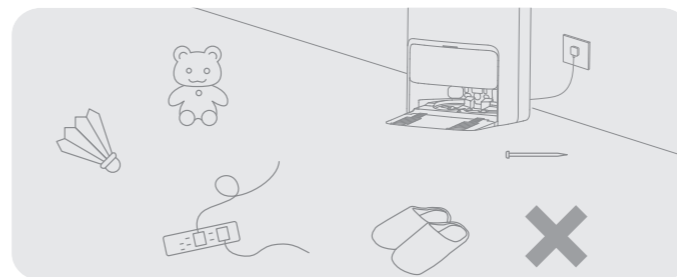

Before cleaning, please move away unstable, fragile, valuable or dangerous items, and clean up cables, cloths, toys, hard objects and sharp objects on the ground to avoid being entangled, scratched or knocked over by the robot and causing losses.

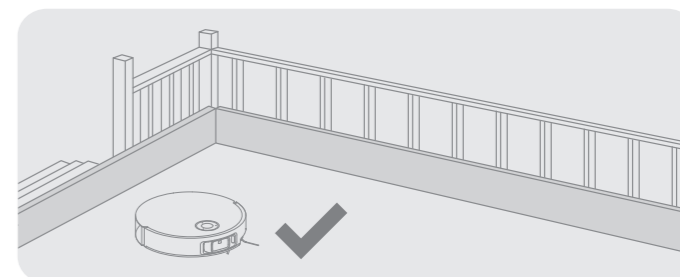

Before cleaning, place a physical barrier at the edge of the stairs to ensure the secure and smooth operations of the robot.

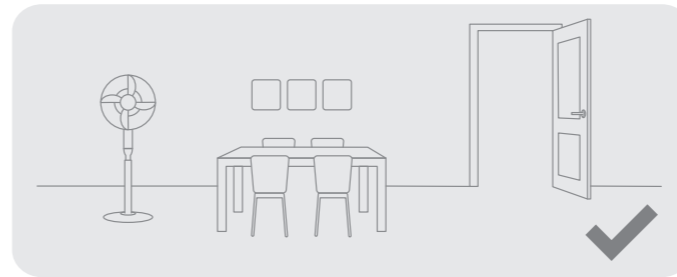

Open the door of the room to be cleaned, and put the furniture in its proper place to leave more space.

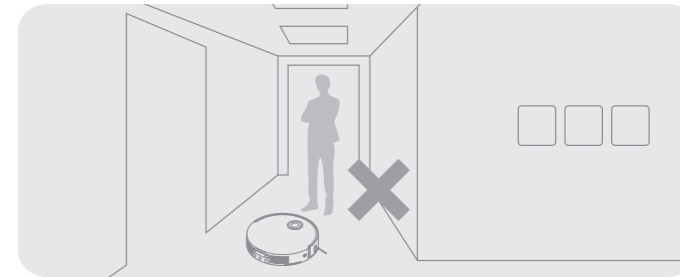

To prevent the robot from missing areas that need to be cleaned, do not stand in front of the robot, threshold, hallway, or narrow places.

Note:

- When operating the robot for the first time, follow it around while cleaning to remove any potential obstacles in time.
- The LED auxiliary light will provide auxiliary lighting in dimly lit environments.
- Do not vacuum hard objects like stones, steel balls and toy parts, or sharp objects like construction waste, broken glass and nails, otherwise the ground may be scratched.

Before Use

1. Place the Base Station and Connect to an Electrical Outlet

Place the base station in a location that is as open as possible with a good Wi-Fi signal. Leave enough space as shown in the figure and remove any objects in the shaded area. Insert the power cord into the base station and plug it into the socket.

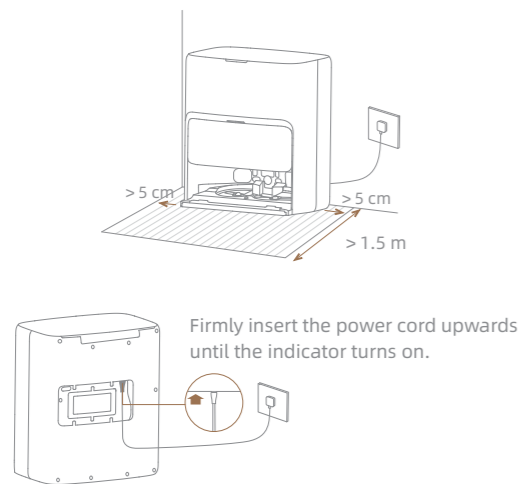

Note:

- Make sure that no objects might block the signaling area.
- To prevent water stains from wetting wood floors or carpets, placing the base station on tile floors or marble floors is recommended.

2. Install the Ramp Extension Plate

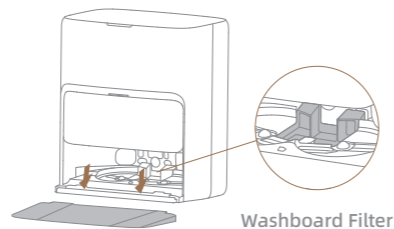

Note: Ensure the washboard filter is installed into place.

Before Use

3. Remove Robot Protections and Install the Mop Assembly

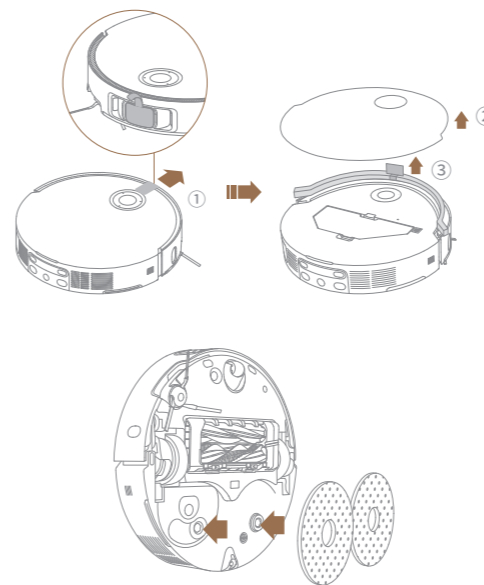

4. Connect the Robot to the Base Station

Press and hold the button (⏻) on the robot for 3 seconds to turn it on. Place the robot onto the base station with the mop assembly facing toward the washboard. Then you will hear a voice notification when the robot successfully connects to the base station. After the robot is fully charged, the status indicators on the robot and the base station will remain lit for 10 minutes and then dim.



Note: It is recommended to fully charge the robot before its first use. When the robot cannot be turned on after the battery is depleted, manually connect the robot with the station to charge it.

Before Use

5. Add MOVA Cleaning and Pet Odor Solution

- ① Remove the dust tank cover and pull out the auto solution dispenser module.
- ② Open the upper lids of the module and add cleaning solution and pet odor solution into specialized compartment, as shown in the figure.
- ③ Close the lids, put the module back into the base station, and then reinstall the dust tank cover.

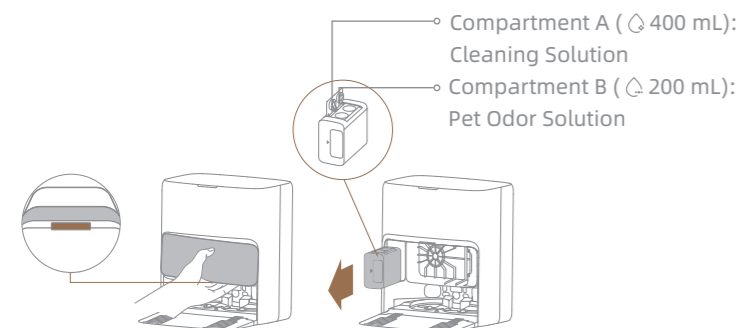

Note:

- Do not confuse cleaning solution with pet odor solution, as it may cause machine malfunction.
- The auto solution dispenser module can be filled up for use. Do not add any liquids that are not officially-approved to prevent malfunction.
- Install the auto solution dispenser module until it clicks into place.

6. Add Water to the Clean Water Tank

Take out the clean water tank from the base station and fill up the tank with clean water. Then install it back into the base station.

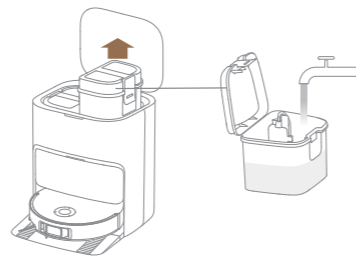

Note: Do not add hot water into the water tank, as this may cause the tank to become deformed.

Connecting with the MOVAhome App

1. Download the MOVAhome App

Scan the QR code on the robot or search "MOVAhome" in the app store to download and install the app.

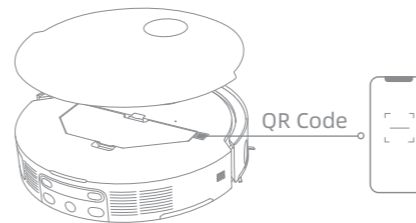

Note:

- Only 2.4 GHz Wi-Fi is supported.
- Due to upgrades in the app software, the actual operations may differ from the directions in this manual. Please follow the instructions based on the current app version.

2. Add Device

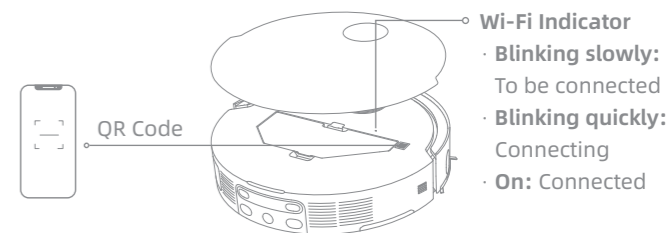

Open the MOVAhome App, tap "Scan QR code to connect", and scan the same QR code on the robot again to add the device. Please follow the prompts to finish the Wi-Fi connection.

Note: To reset Wi-Fi, repeat step 2 and then follow the prompts to finish the Wi-Fi connection.



How to Use

Turn On/Off

Press and hold the button  for 3 seconds to turn on the robot. The power indicator will remain lit. Or, place the robot onto the base station by aligning the charging contacts of the robot with those of the base station, and then the robot will turn on automatically and begin charging. To turn off the robot, move the robot away from the base station and press and hold the button  for 3 seconds.

Fast Mapping

After configuring the network for the first time, follow the instructions in the app to quickly create a map. The robot will start mapping without cleaning. When the robot returns to the base station, the mapping process has been completed and the map will be saved automatically.

Pause/Sleep

When the robot is running, press any button to pause it.

If the robot is paused for more than 10 minutes, it automatically enters sleep mode. All indicators on the robot will turn off. Press any button on the robot, or use the app to wake up the robot.

Note: If the robot is paused and placed onto the base station, the current cleaning process will end.

Auto Resume Cleaning

If the battery is too low, the robot will automatically return to the base station to charge. After charging to the appropriate battery level, it will resume unfinished cleaning tasks.

Note: To use this function, please enable it in the app.



Do Not Disturb (DND) Mode

When the robot is set to the Do Not Disturb (DND) mode, the robot will be prevented from resuming cleaning. The DND mode is disabled by default at the factory. You can use the app to enable the DND mode or modify the DND period. The DND period is 22:00-8:00 by default.

Note:

- The scheduled cleaning tasks will be performed as usual during the DND period.
- The robot will resume cleanup where it left off after the DND period expires.

Robot Restarting

If the robot stops responding or cannot be turned off, press and hold the button  for 10 seconds to forcefully turn it off. Then, press and hold the button  for 3 seconds to turn the robot on.

How to Use

Vacuum and Mop

Note: After installing the mop assembly, the robot will operate in "Vacuum and Mop" mode by default during its first use.

1. Start cleaning

Press the button  on the robot, or use the app to make the robot start from the base station. Then the robot will plan the optimal cleaning route and perform the cleaning task based on the created map.

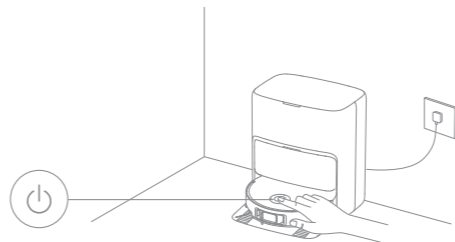

Note:

- To ensure the robot easily returns to the base station after cleaning, it is recommended to make the robot start from the base station.
- The mop pads will be cleaned before the robot starts mopping, please wait patiently.
- Do not move the base station, the clean water tank, the used water tank, or the washboard filter during operation.
- Hot water cleaning can be enabled in the app for mop pad cleaning, which applies to all modes. To prevent scalding, do not touch the water outlet when the function is on.

2. Auto mop washing

When cleaning, the robot will automatically return to the base station to wash mop pads based on the mop pad cleaning frequency specified in the app. The base station will automatically refill the robot's water tank and the robot will resume cleanup.

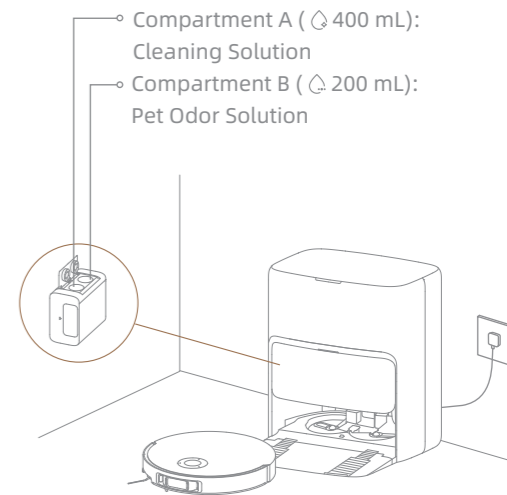

Note: Configure the auto solution dispenser module via app for different solution uses.

How to Use

3. Automatically empty the dust box and wash and dry the mop pads

After the robot finishes a cleaning task and returns to the base station to charge, the base station will automatically empty the dust box and then wash and dry the mop pads.

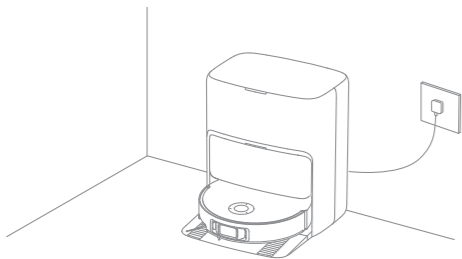

Note:

- If the auto-empty function is turned off in the app, the base station will not automatically empty the dust box.
- The base station will empty the dust box according to the setting in the app.

4. Clean the used water tank

After the robot has completed its task, please clean the used water tank to prevent any odor.

Mop after Vacuuming

Enable the mopping after vacuuming function in the app, and the robot will automatically remove the mop assembly on the base station to vacuum the floor. After vacuuming is completed, the robot will return to the base station to install the mop assembly and the base station will automatically empty the dust box. And then, the robot will start mopping after the main brushes and side brush are raised.

Vacuum Only

Enable the vacuuming function in the app, and the robot will automatically remove the mop assembly on the base station and start vacuuming.

Mop Only

Enable the mopping function in the app, and the robot will automatically check if the mop assembly is installed on the base station. If not, the robot will install the mop assembly and start mopping after the main brushes and side brush are raised.

Routine Maintenance

Parts

To keep the robot in good condition, it is recommended to refer to the accessory usage in the app or the following table for routine maintenance.

Part	Maintenance Frequency	Replacement Period
Used water tank	After each use	/
Clean water tank	Once every 2 weeks	
Main brushes		Every 6 to 12 months
Dust box's filter		Every 3 to 6 months
Side brush		
Mop pad holders		/
Washboard filter	Once every 1 to 2 months	/
Base station's signaling area	Once every month	
Charging contacts		
Auto-empty vents		
Omnidirectional wheel		
Caster wheel		
Edge sensor		
VersaLift sensor		
3D dual-line laser sensors		

Part	Maintenance Frequency	Replacement Period
Carpet sensor	Once every month	/
Cliff sensors		
Bumper window		
Bumper		
Robot's automatic water refilling inlet		
Bottom of the robot		
Dust box	Clean it as needed	/
Main wheels		
Clearance legs		
Dust bag	/	Every 2 to 4 months
Mop pads		Every 1 to 3 months
Scale inhibitor		Every 18 to 36 months

Note: The frequency of maintenance and replacement depends on actual usage. If an exception occurs due to special circumstances, prompt maintenance or replacement is recommended.

Routine Maintenance

Washboard Filter

1. Take out the robot and remove the washboard filter after the mop pad cleaning is complete.

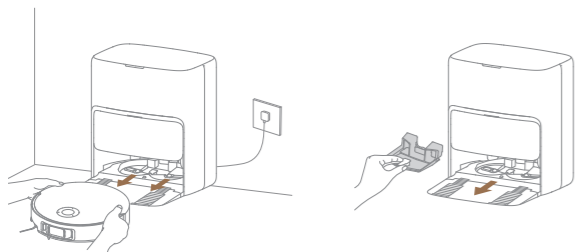

2. Rinse the washboard filter with clean water, wipe it clean, and then reinstall it in the washboard.

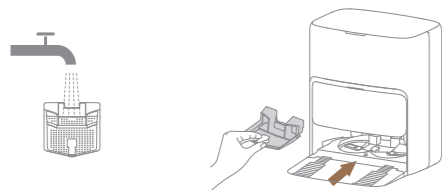

3. Use the app or press the button  to return the robot to the base station, or manually put the robot back.

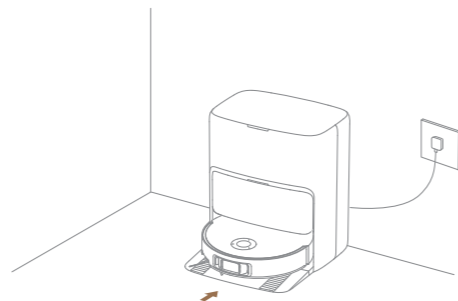

Routine Maintenance

Dust Bag

1. Remove the dust tank cover and discard the dust bag.

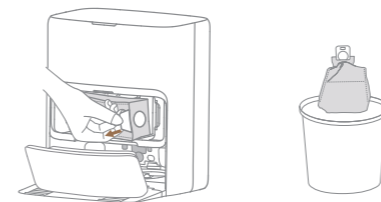

Note: Pulling outwards on the handle will seal the bag to prevent the dust and debris from accidentally falling out.

2. Remove the dust and debris from the filter with a dry cloth.

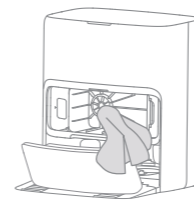

3. Install a new dust bag.

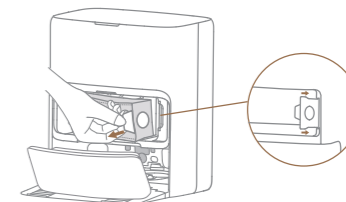

4. Reinstall the dust tank cover.

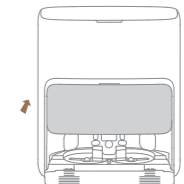

Routine Maintenance

Used Water Tank

1. Remove the used water tank, open its cover and pour out the used water.



2. Rinse the used water tank with clean water, and use a proper cleaning tool to clean the inner wall of the used water tank.



Note: The float ball in the used water tank is a movable part. Do not apply too much force when cleaning it to avoid damaging it.

Routine Maintenance

Main Brushes

1. Press the brush guard clips inwards to remove the brush guard, and then lift the brushes out of the robot.

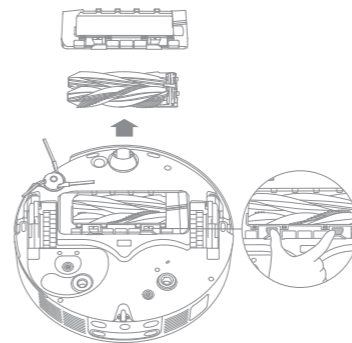

2. Pull out the brushes as shown in the figure. Use a proper cleaning tool to remove any hair tangled in the brush. After cleaning, push the brushes firmly into the main brush holder until they click into place.

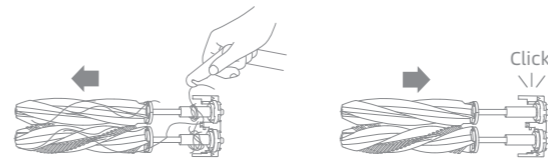

Note: Be careful while pulling out the main brushes to prevent injury.

3. With the screen-printed arrows facing upwards, insert the main brush holder into the slots downwards in an inclined way.

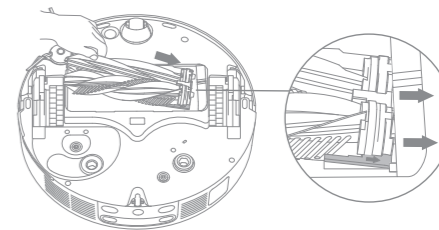

4. Align the front end of the brush guard with the slot, insert it downwards in an inclined way, and then press it into place.

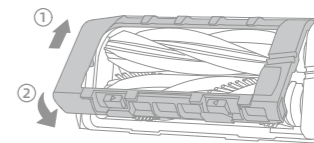

Routine Maintenance

Side Brush

Unscrew the side brush with a screwdriver, clean the hair from the brush, and then screw it back on.

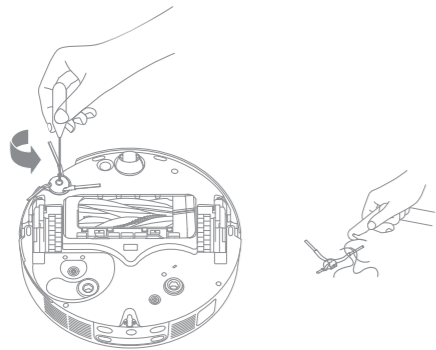

Mop Pad Holders

Remove and clean the mop pad holders.

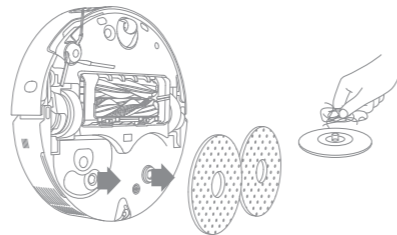

Omnidirectional Wheel

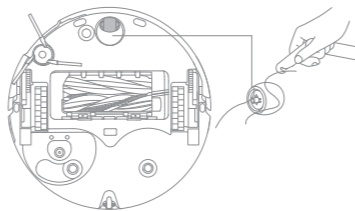

Note:

- Use a tool such as a small screwdriver to separate the axle and tire of the omnidirectional wheel. Do not use excessive force.
- Rinse the omnidirectional wheel under the running water and put it back after drying it completely.

Routine Maintenance

Dust Box and Filter

1. Remove the robot cover and press the dust box clip to remove the dust box.

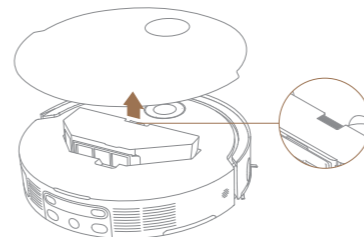

2. Remove the dust box filter, and then empty the dust box.

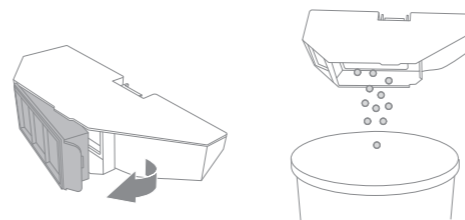

3. Gently tap the basket of the filter to remove the dirt.

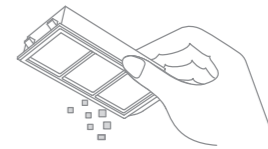

Note: Do not attempt to clean the filter with a brush, a finger or sharp objects to prevent damage.

4. Rinse the dust box and filter with water and dry them completely before reinstalling.

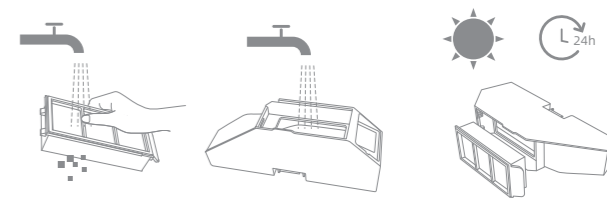

Note:

- Rinse the dust box and filter with clean water only. Do not use any detergent.
- Use the dust box and filter only when they are completely dry.

Routine Maintenance

Robot Sensors

Wipe the robot sensors by using a soft and dry cloth, as shown in the below figure:

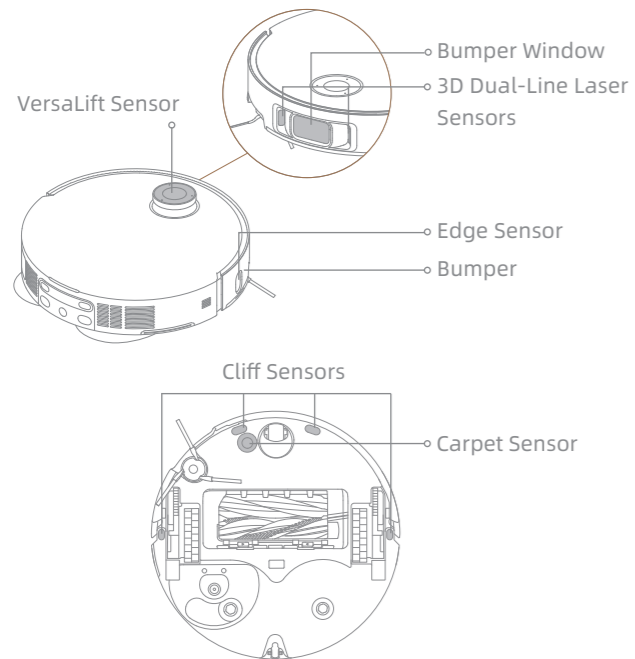

Note: A wet cloth can damage sensitive elements within the robot and the base station. Please use a dry cloth for cleaning.

Charging Contacts and Signaling Area

Clean the charging contacts and the signaling area with a soft and dry cloth.

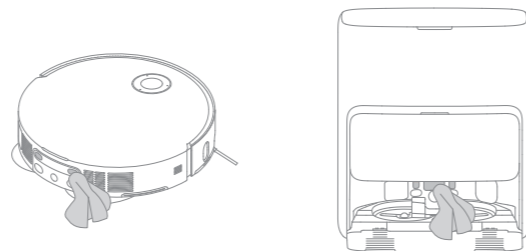

Routine Maintenance

Auto-Empty Vents

Clean the auto-empty vents of the robot and the base station with a soft and dry cloth.

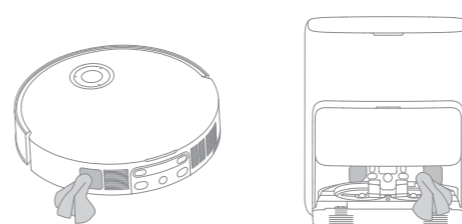

Mop Pads

Remove the mop pads from the mop pad holders to replace them.

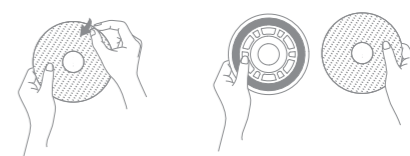



Battery

The robot contains a high-performance lithium-ion battery pack. Make sure that the battery remains well-charged for daily use to maintain optimal battery performance. If the robot is not used for an extended period of time, turn it off and put it away. To prevent damage from over-discharging, charge the robot at least once every three months.

Troubleshooting

Problem	Solution
The robot will not turn on.	The battery is low. Recharge the robot on the base and try again. The temperature of the battery is too low or too high. It is recommended to use the robot in environments with an ambient temperature above 0 °C (32 °F) and below 40° C (104° F).
The robot will not charge.	The base station is not connected to power, please make sure both ends of its power cord are correctly plugged in. The contact between the charging contacts on the base station and the robot is poor, please clean the charging contacts. Check whether there is any foreign object at the connectors of the robot and remove the foreign object if any.
The robot fails to connect to Wi-Fi.	The Wi-Fi network password is incorrect. Make sure the password used to connect to your Wi-Fi network is correct. The robot does not support a 5 GHz Wi-Fi connection. Make sure the robot is connected to a 2.4 GHz Wi-Fi connection. The Wi-Fi signal is weak. Make sure the robot is in an area with good Wi-Fi coverage. The robot may not be ready to be configured. Please exit and re-enter the app, and then try again as instructed.
The robot cannot find and return to the base station.	The base station is disconnected from power or moved when the robot is not on it. Please connect the base station to the power supply or place the robot onto the base station to charge. There are too many obstructions around the base station. Place the base station in a more open area. Moving the robot may cause it to re-position itself, and it will recreate a map if re-positioning fails. If the robot is too far from the base station, it might not be able to automatically return on its own, in which case you will need to manually place the robot onto the base station. Wipe the signaling area on the base station to remove dust or debris.

Troubleshooting

Problem	Solution
The robot gets stuck in front of the base station and cannot return to it.	Check whether there is enough space on both sides or in front of the base station to prevent the robot from being blocked. The route for returning to charge is blocked, e.g. the door is closed. The robot may slip if the floor in front of the base station is overly wet. If so, clean the excess water before trying again. It is recommended to move the base station to a different place and try again. Make sure the ramp extension plate is installed properly.
The robot will not turn off.	The robot cannot be turned off when it is charging. It is recommended to move the robot from the base station, and then press and hold the button  for 3 seconds to turn it off. If the robot cannot be turned off by performing step 1, press and hold the button  for 10 seconds to forcibly turn off the robot. If the problem persists, please contact after-sales service.
The charging speed is slow.	It takes about 4.5 hours to fully charge the robot when its battery is low. If you operate the robot at temperatures outside of the specified range, the charging speed will automatically slow down to extend the battery life. The charging contacts on both the robot and the base station may be dirty, please wipe them with a dry cloth.
The noise increases while the robot is operating.	Check whether the dust box filter is clogged. If so, clean it or replace it. A hard object may be caught in the main brushes or the dust box. Check and remove any hard object. The main brushes or the side brush may become tangled. Check and remove any foreign objects. Switch the suction mode to Standard or Quiet.
The robot moves without following the set route.	Objects such as power cords and slippers should be organized before using the robot. Working on wet slippery surfaces causes the main wheel to slip. It is recommended to dry the wet places before using the robot. Wipe the bumper window and 3D dual-line laser sensors on the robot with a clean, soft cloth to keep them clean and unobstructed.

Troubleshooting

Problem	Solution
The robot misses the rooms to be cleaned.	Make sure that the doors of the rooms to be cleaned are open. The place in front of the room to be cleaned may be wet and slippery, causing the robot to slip and work abnormally. Please try drying the floor before using the robot.
The robot will not resume cleaning after charging.	Make sure that the robot is not set to the Do Not Disturb (DND) mode, which will prevent it from resuming cleaning. The robot will not resume cleaning after you manually place the robot on the base station or send the robot to charge via the app or the button  .
The station cannot automatically empty the dust box.	Check whether the dust bag in the dust tank is full. If the dust bag is not full, check whether there is any obstruction at the auto-empty vents of the robot, the base station, or the dust box. If any, clean the blocked part in time.
The water level in the washboard is abnormal.	Check whether the seal on the used water tank is loose or not correctly installed, and manually reset it if so. If the problem persists, please contact the after-sales service team. Gently press down on the used water tank to make sure it is installed correctly. Remove the washboard filter and check whether the sewage drain outlet is blocked and clean it. Check the cleaning solution. Do not add any liquid other than the officially-approved cleaning solution.
The mop pad holder is raised abnormally.	Please remove the mop pad holder to check if there is any foreign object stuck in it, and try to restart the robot. If the problem persists, please contact the after-sales service team.
There is water under the clean water tank or around the seal.	When taking out the clean water tank, some water in the pipe may be left under the tank or around the seal. This is normal. Please wipe with a dry cloth.

For more support, contact us via www.mova-tech.com

Specifications

Robot

Model	RLV72LE
Charging Time	Approx. 4.5 hours
Rated Voltage	14.4 V ⁼⁼⁼
Rated Power	75 W
Operation Frequency	2400-2483.5 MHz
Maximum Output Power	< 20 dBm

Under normal use of condition, this equipment should be kept a separation distance of at least 20 cm between the antenna and the body of the user.

Base Station

Model	RCVE0202
Rated Input	220-240 V~ 50-60 Hz
Rated Output	20 V ⁼⁼⁼ 2 A
Rated Power (during dust emptying)	700 W
Rated Power (during hot water cleaning)	1160 W
Rated Power (during charging and drying)	95 W

Note:

- Rated Power (during hot water cleaning) is determined by the power value during the representative period (water temperature 25°C).
- Rated Power (during charging and drying) is determined by the power value during full load period.

Battery Disposal and Removal

The built-in lithium-ion battery contains substances that are hazardous to the environment. Before disposing of the battery, make sure the battery is removed by qualified technicians and discarded at an appropriate recycling facility.

- the battery must be removed from the appliance before it is scrapped;
- the appliance must be disconnected from the supply mains when removing the battery;
- the battery is to be disposed of safely.

CAUTION:

Before removing the battery, disconnect the power and run out the battery as much as possible.

Unneeded batteries should be discarded at an appropriate recycling facility.

Do not expose to high temperature environment to avoid risks of explosion.

Under abusive conditions, liquid may be ejected from the battery. If contact occurs, flush with water and seek medical help.

Removal Guide:

1. Turn over the robot, use a proper tool to remove the screws on the back of the robot, and then remove the cover.
2. Unplug the terminals between the battery and PCB board to remove the battery.

WEEE Information



All products bearing this symbol are waste electrical and electronic equipment (WEEE as in directive 2012/19/EU) which should not be mixed with unsorted household waste. Instead, you should protect human health and the environment by handing over your waste equipment to a designated collection point for the recycling of waste electrical and electronic equipment, appointed by the government or local authorities. Correct disposal and recycling will help prevent potential negative consequences to the environment and human health. Please contact the installer or local authorities for more information about the location as well as terms and conditions of such collection points.