

H390

Setup Guide

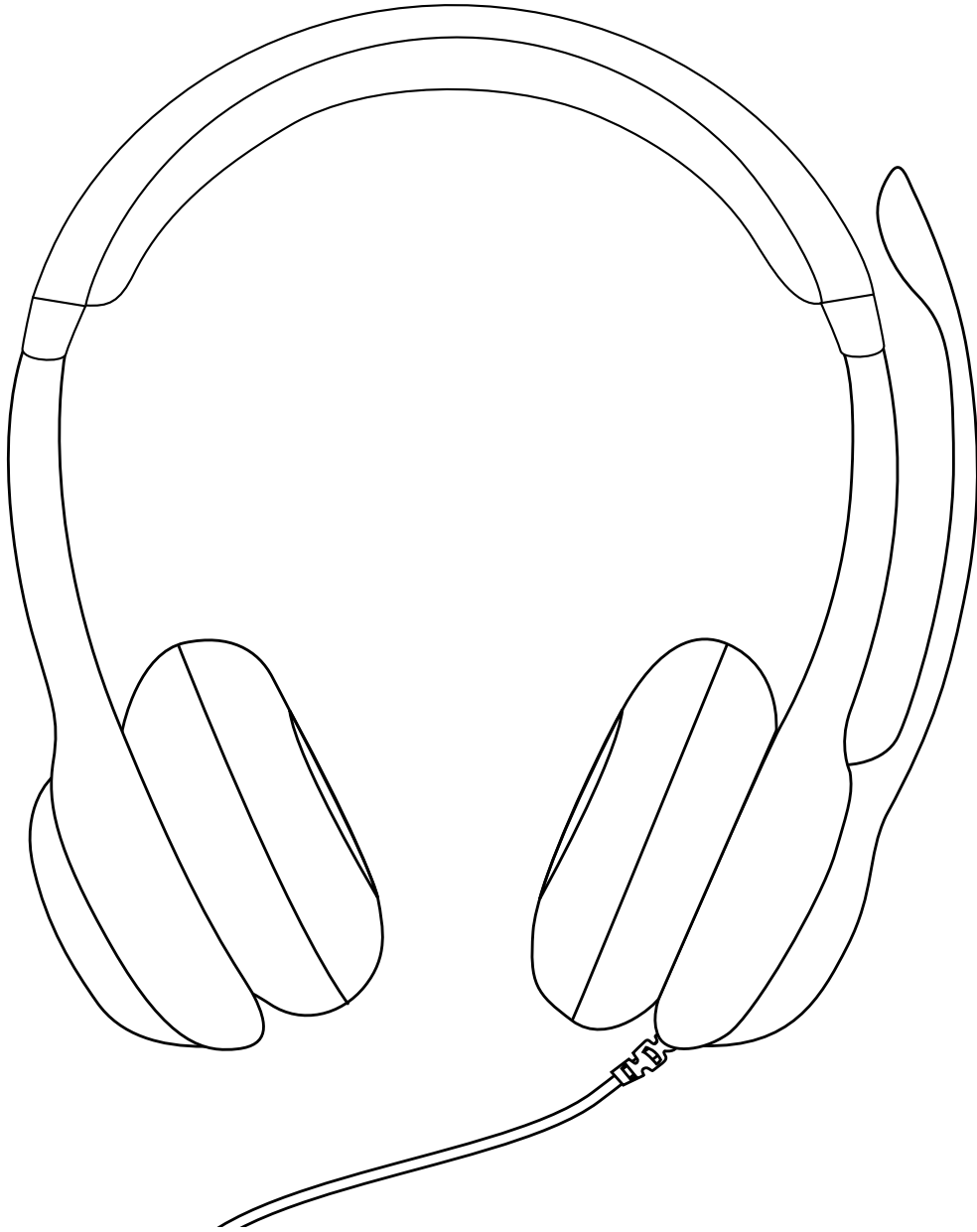

CONTENTS

English	3	Česká verze	48
Deutsch	6	Slovenčina	51
Français	9	Українська	54
Italiano.	12	Eesti	57
Español.	15	Latviski	60
Português	18	Lietuvių.	63
Nederlands	21	Български.	66
Svenska	24	Hrvatski	69
Dansk	27	Srpski.	72
Norsk.	30	Slovenščina	75
Suomi	33	Română	78
Ελληνικά.	36	Türkçe	81
По-руски.	39	84 العربية	
Po polsku.	42	87 עברית	
Magyar.	45		

KNOW YOUR PRODUCT

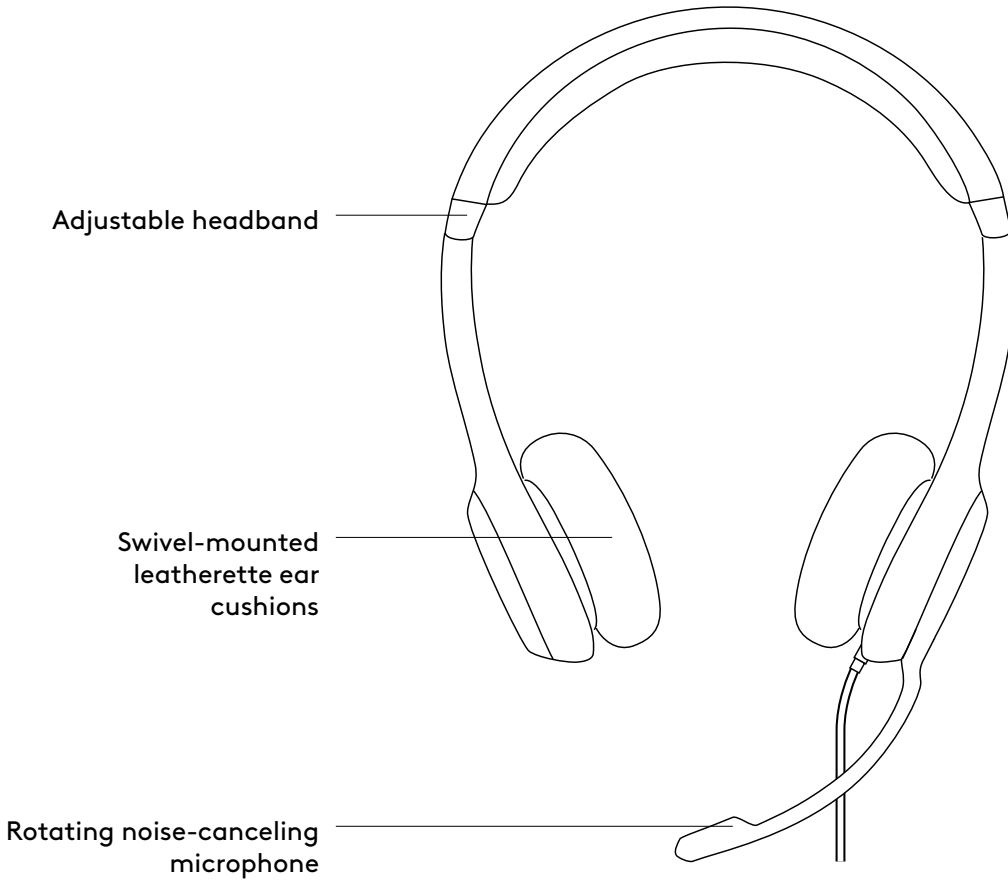

IN-LINE CONTROLLER

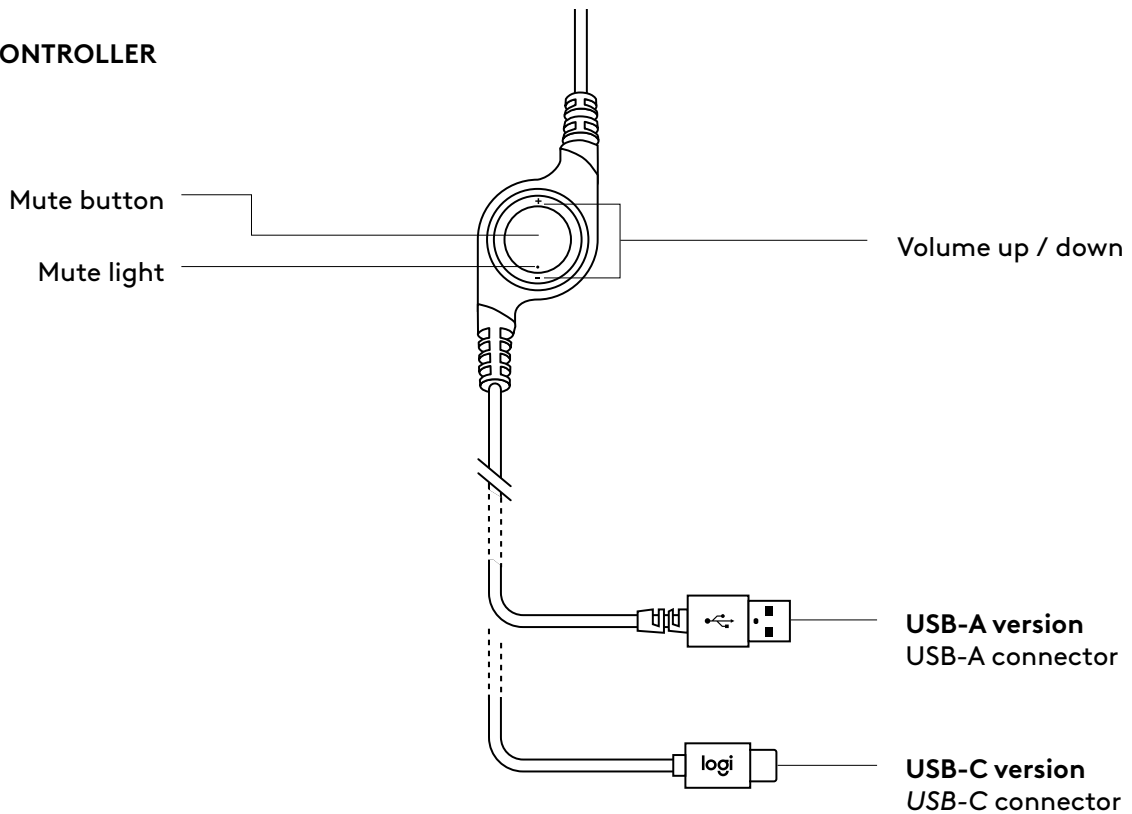

CONNECTING THE HEADSET

Plug the USB connector into the computer USB port.

USB-A version

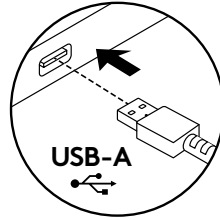

USB-C version

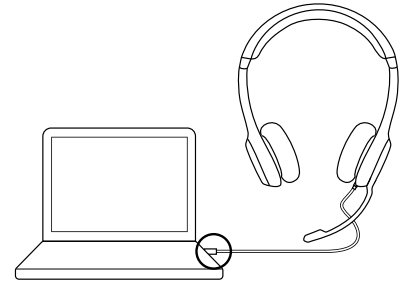
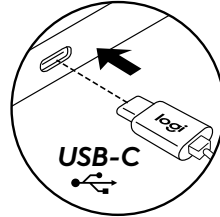

HEADSET FIT

1. To adjust headset size, move the headband up and down until it fits comfortably.
2. Move the microphone boom up or down until it is level with your mouth for better voice capture.
3. Boom can be tucked out of the way when not being used.

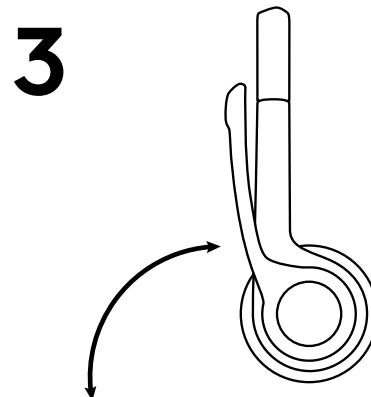
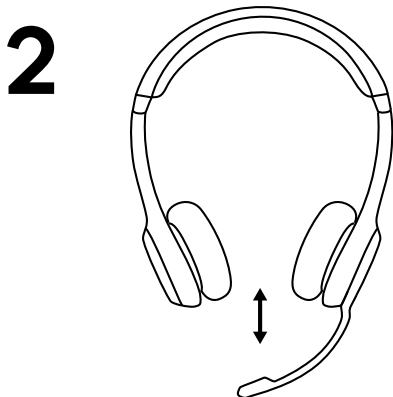
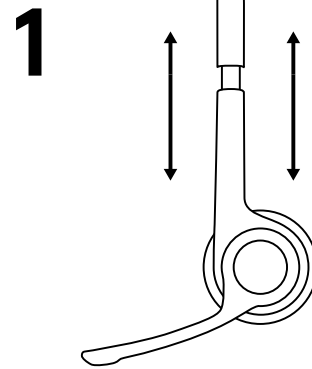

CONTROLS

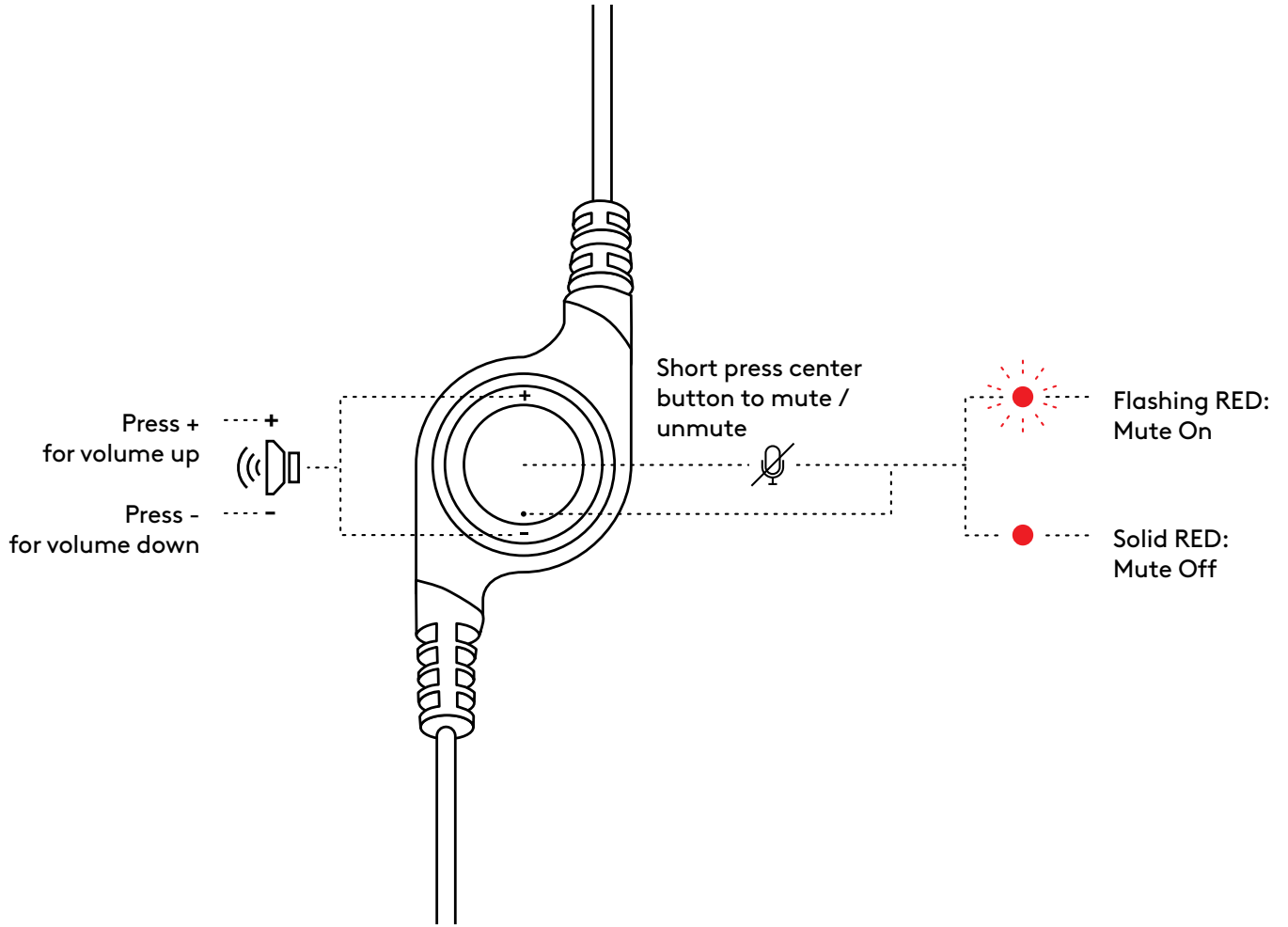

www.logitech.com/support/H390

PRODUKT AUF EINEN BLICK

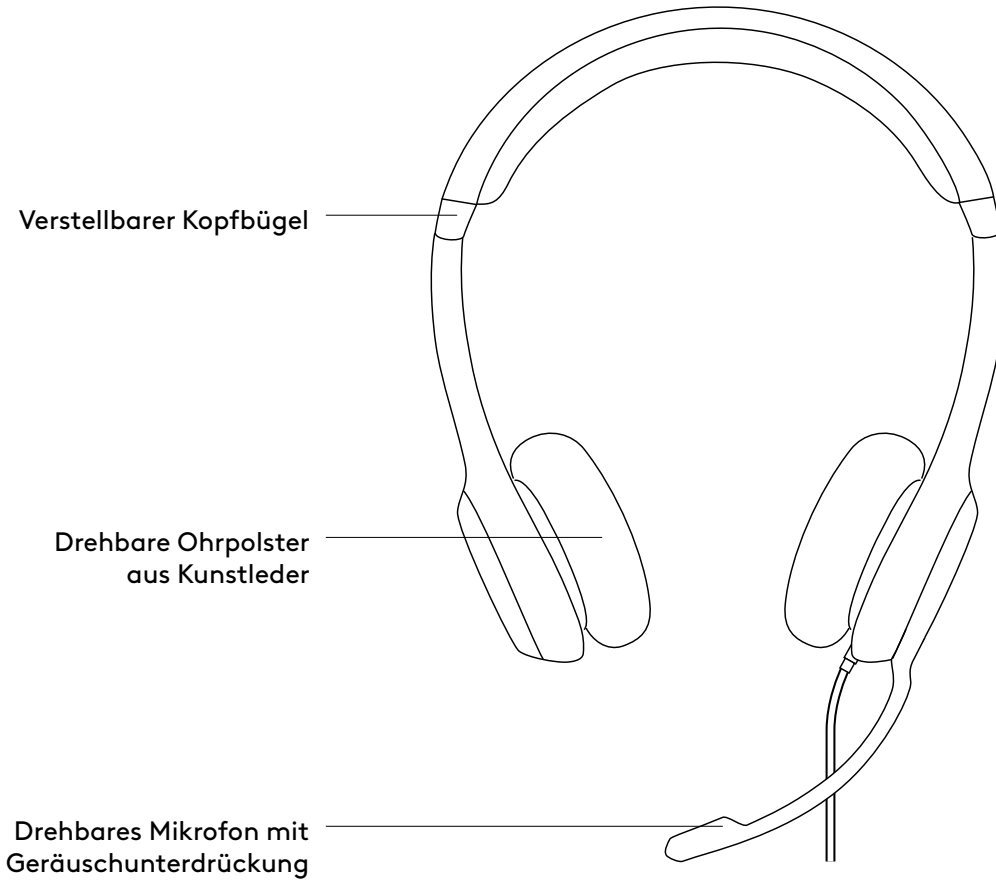

BEDIENELEMENTE AM KABEL

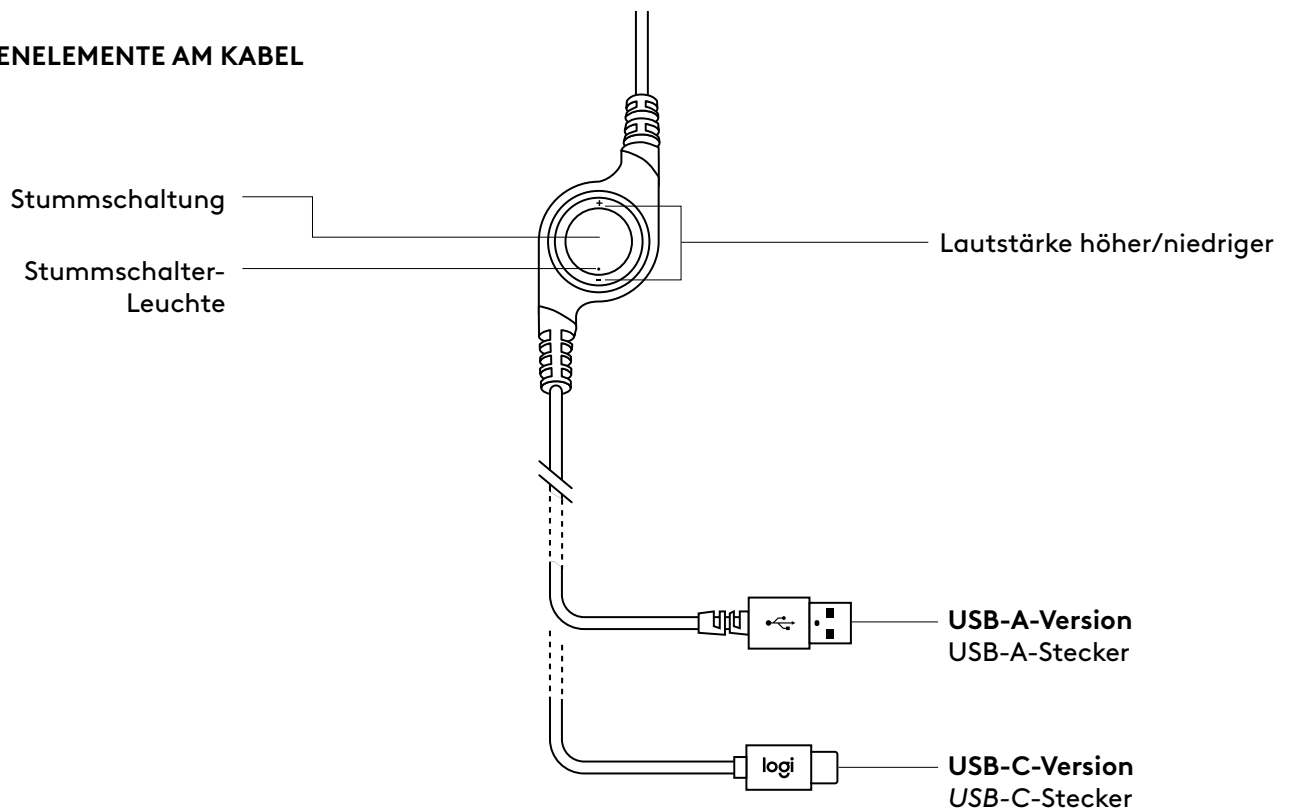

VERBINDEN DES HEADSETS

Schließen Sie den USB-Stecker am USB-Anschluss des Computers an.

USB-A-Version

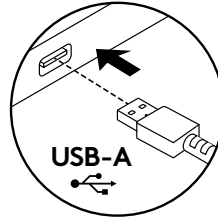

USB-C-Version

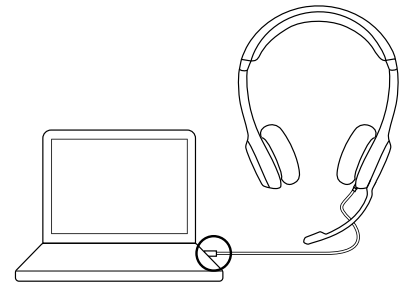
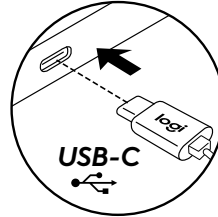

HEADSET-ANPASSUNG

1. Bewegen Sie zum Anpassen der Größe des Headsets den Kopfbügel auf und ab, bis es bequem sitzt.
2. Passen Sie den Mikrofonbügel so an, dass er sich auf Höhe Ihres Mundes befindet, um eine optimale Spracherfassung zu erreichen.
3. Das Bügelmikrofon lässt sich nach oben wegklappen, wenn Sie es nicht benötigen.

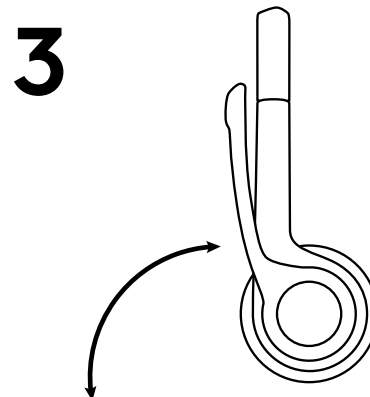
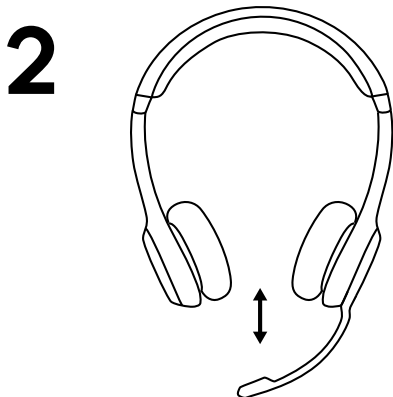
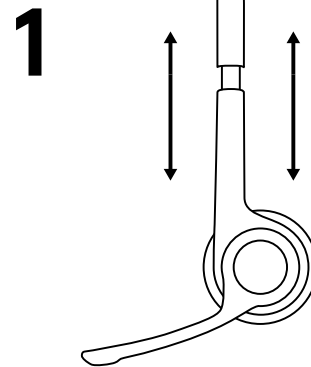

BEDIENELEMENTE

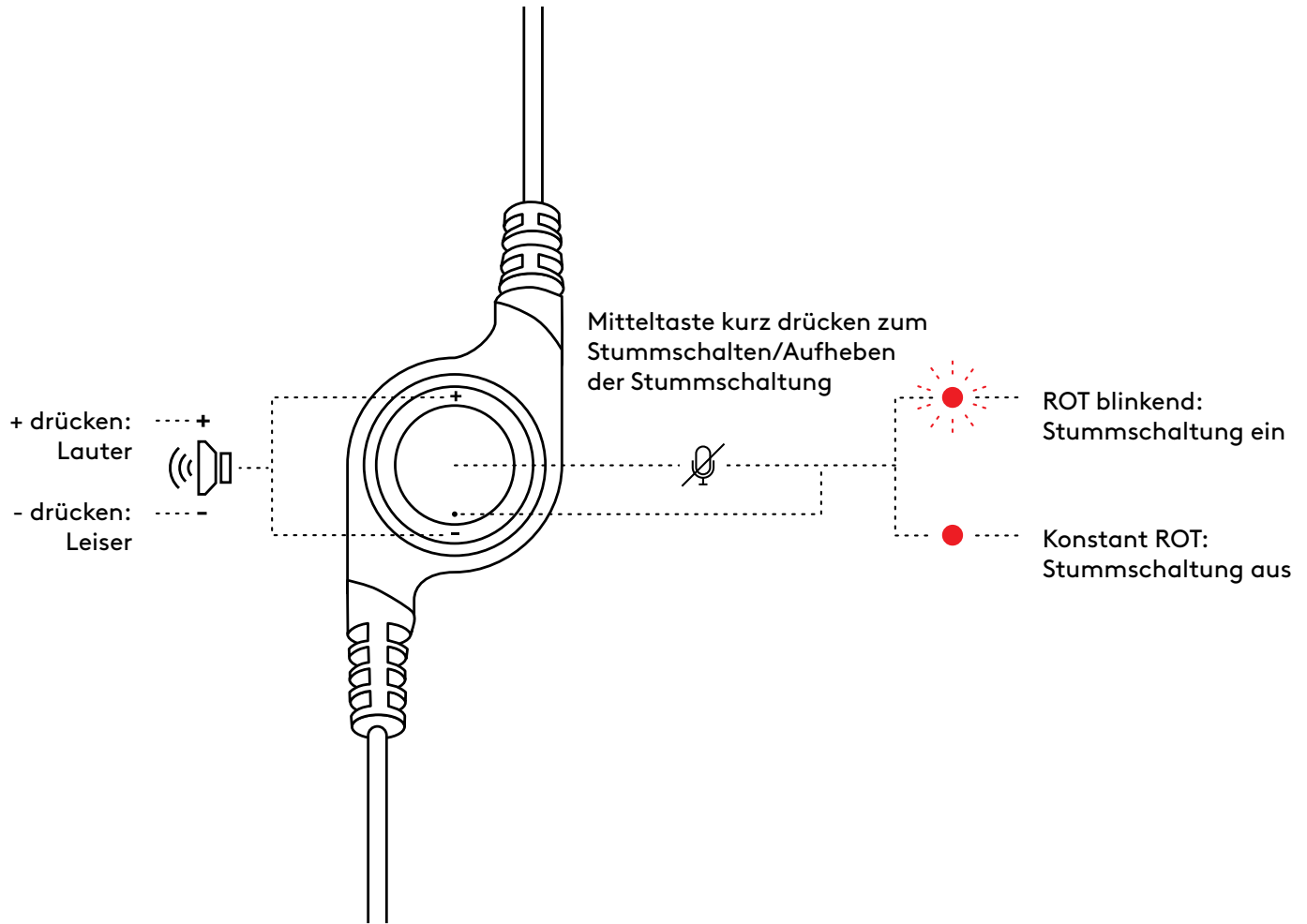

www.logitech.com/support/H390

PRÉSENTATION DU PRODUIT

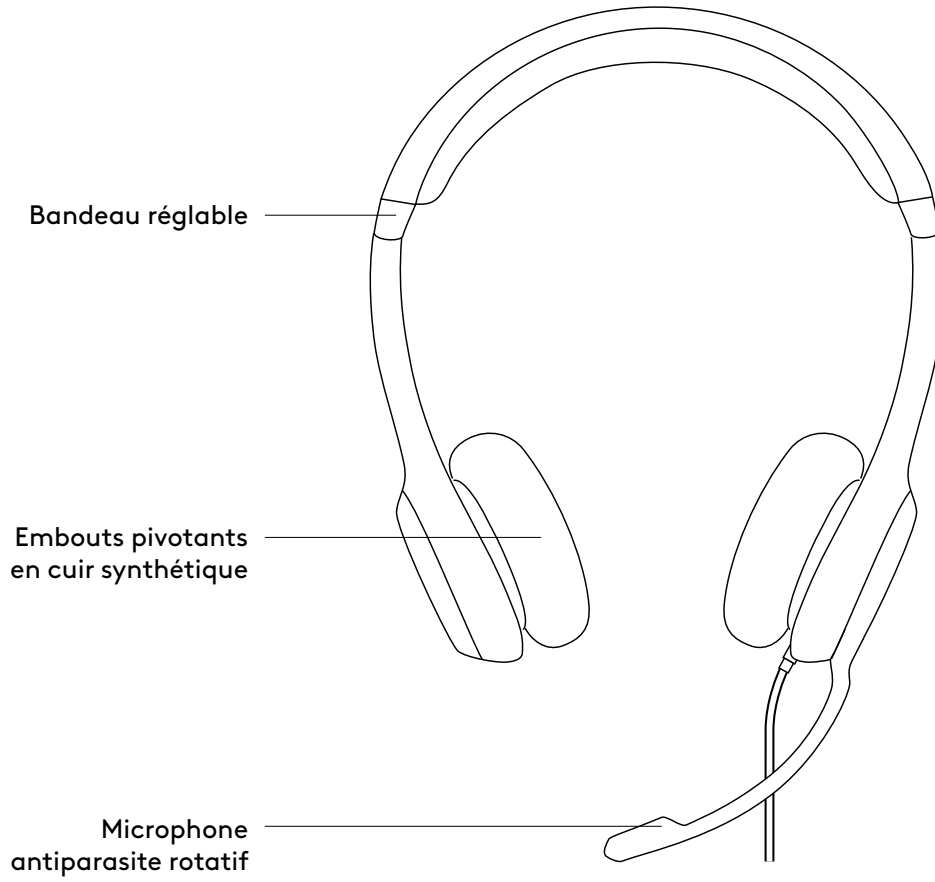

CONTRÔLEUR INTÉGRÉ

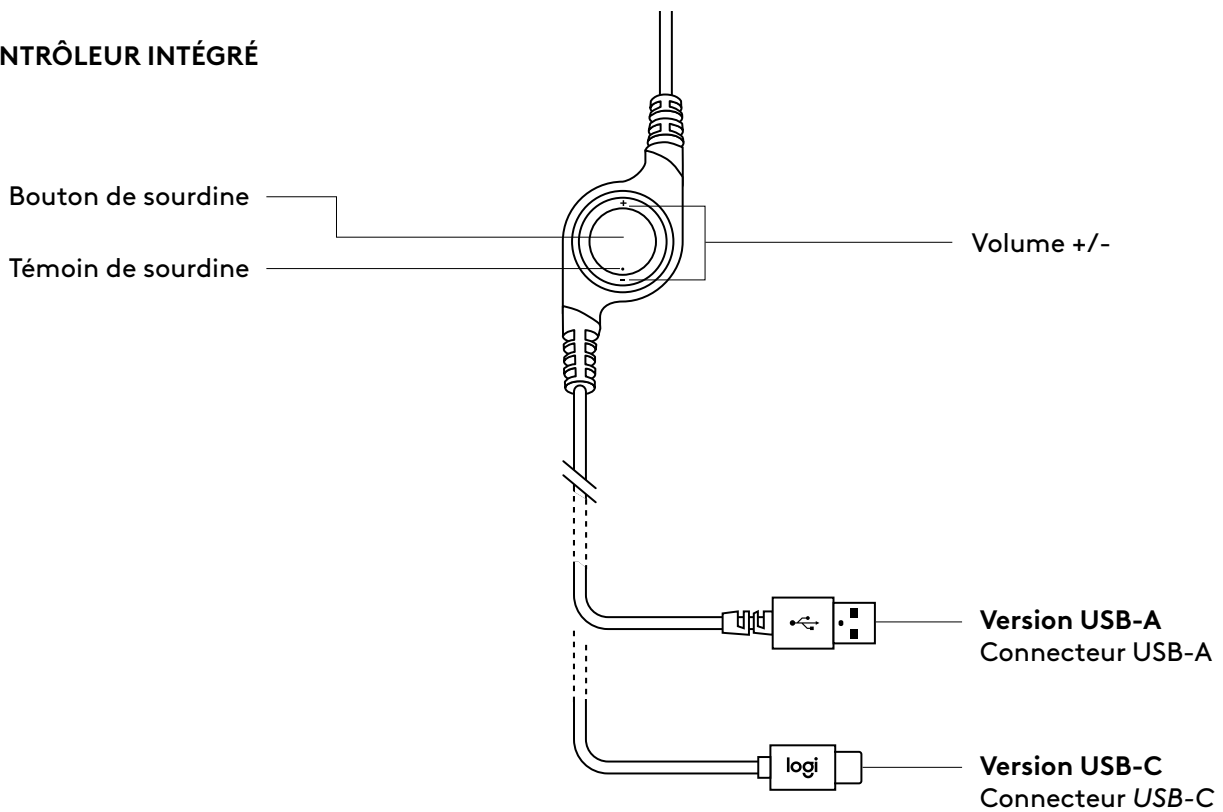

BRANCHEMENT DU CASQUE

Branchez le connecteur USB sur un port USB de l'ordinateur.

Version USB-A

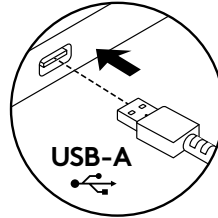

Version USB-C

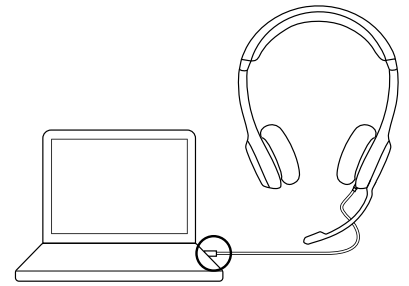
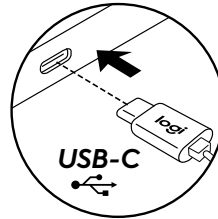

AJUSTEMENT DU CASQUE

1. Pour ajuster la taille du casque, déplacez le bandeau de haut en bas jusqu'à ce qu'il soit confortable.
2. Déplacez la tige du microphone vers le haut ou vers le bas jusqu'à ce qu'elle soit au niveau de votre bouche pour une meilleure capture de la voix.
3. La tige peut être rabattue lorsque vous ne l'utilisez pas.

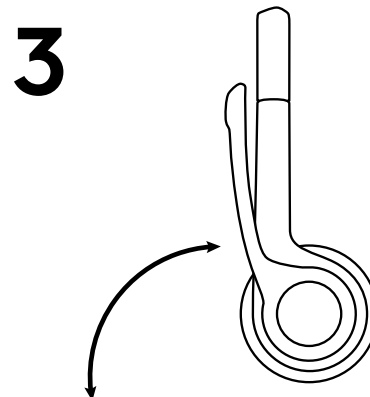
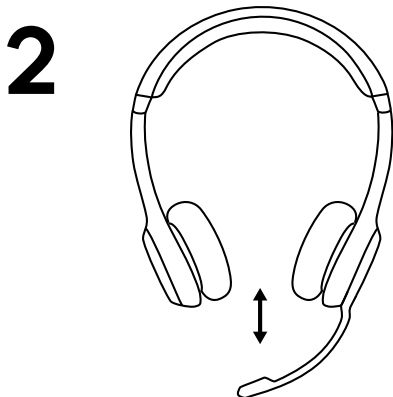
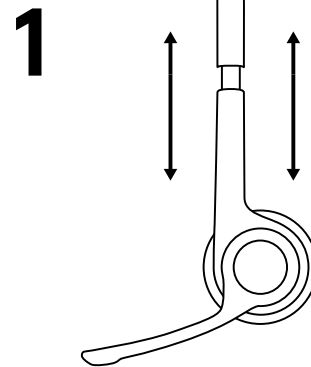

COMMANDES

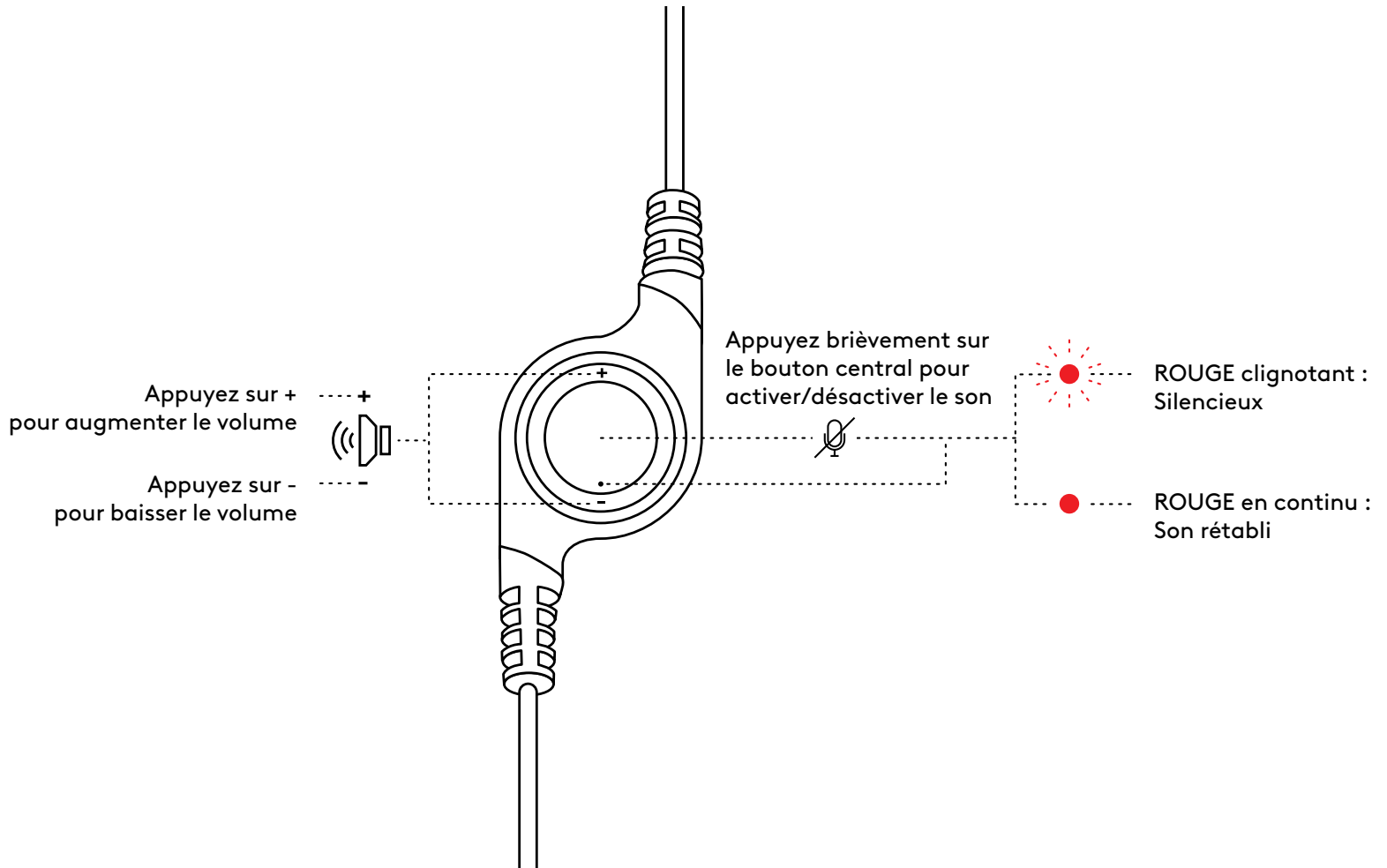

www.logitech.com/support/H390

PANORAMICA DEL PRODOTTO

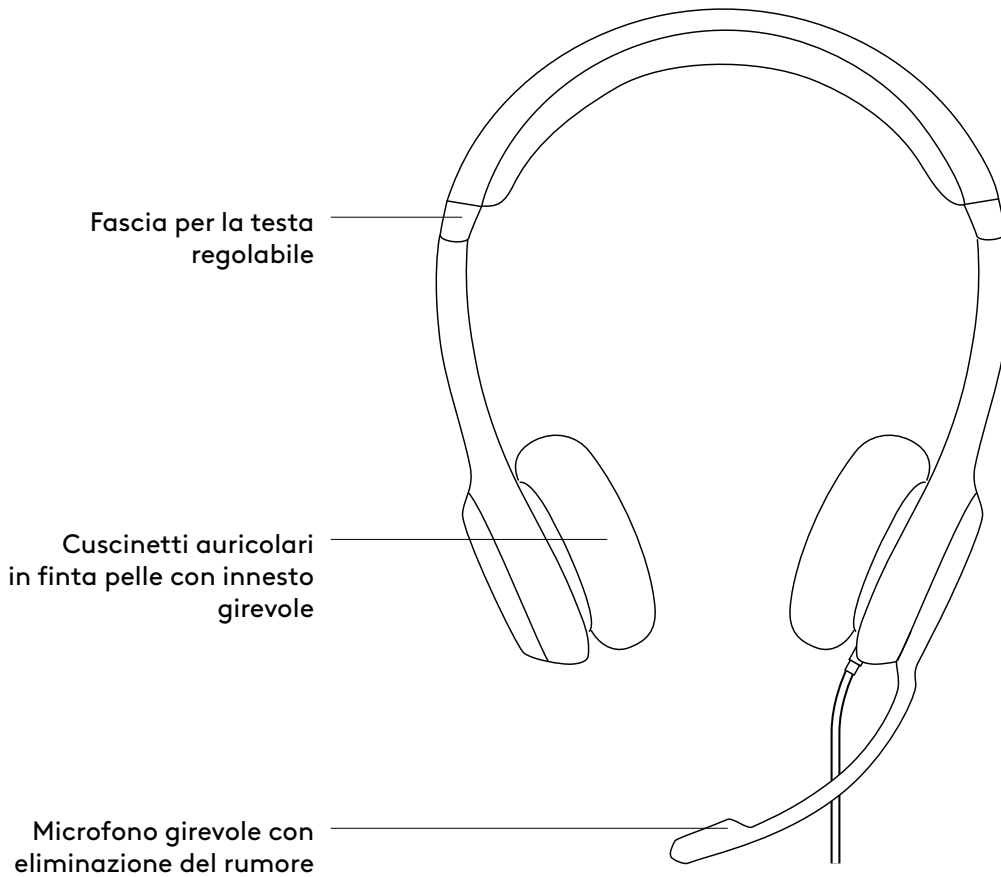

CONTROLLI SUL CAVO

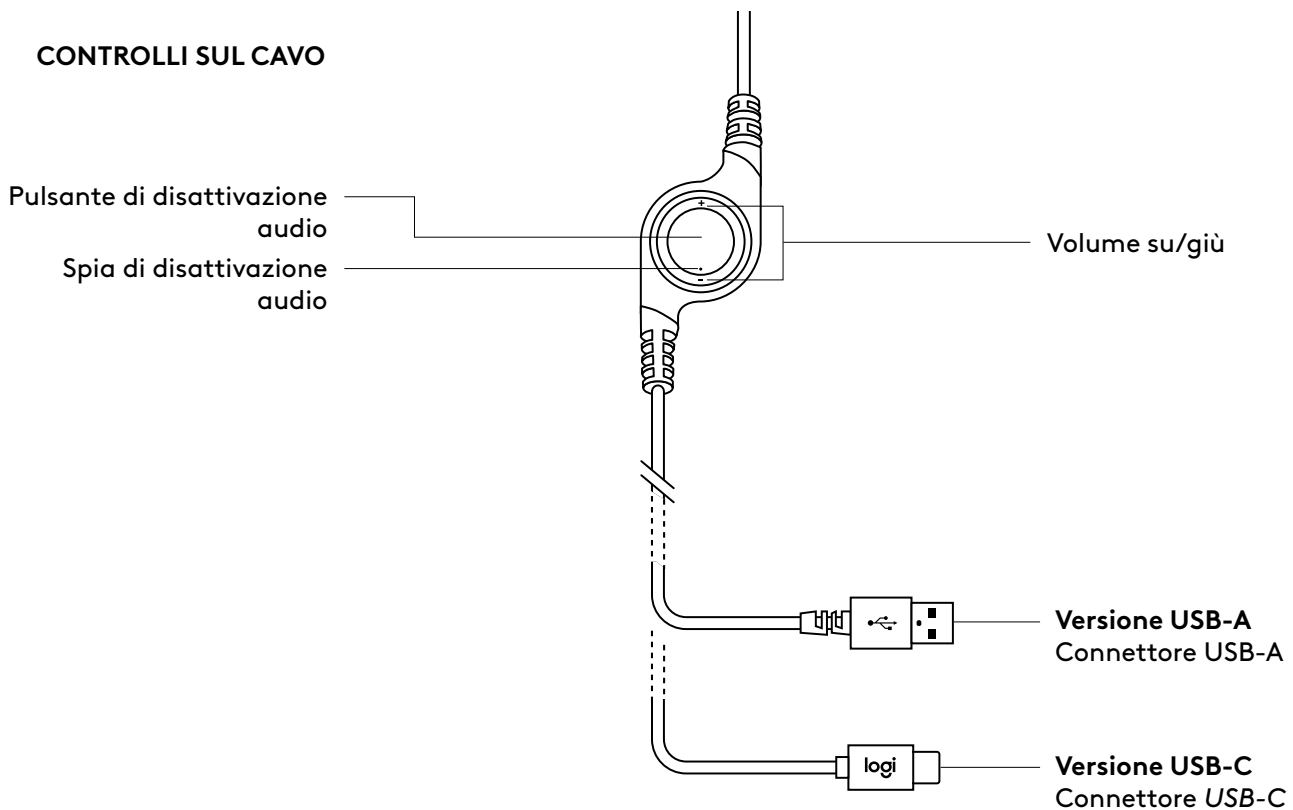

CONNESSIONE DELLA CUFFIA CON MICROFONO

Collegare il connettore USB alla porta USB del computer.

Versione USB-A

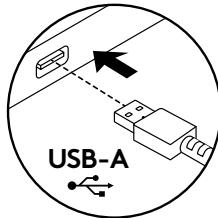

Versione USB-C

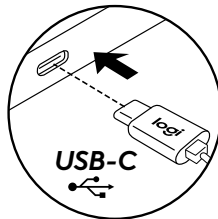

ADATTAMENTO DELLA CUFFIA CON MICROFONO

1. Per adattare le dimensioni della cuffia con microfono, sposta la fascia per la testa in alto e in basso finché non si posiziona comodamente.
2. Sposta il microfono verso l'alto o verso il basso fino a portarlo all'altezza della bocca per una migliore acquisizione della voce.
3. Sposta il microfono fuori portata quando non lo utilizzi.

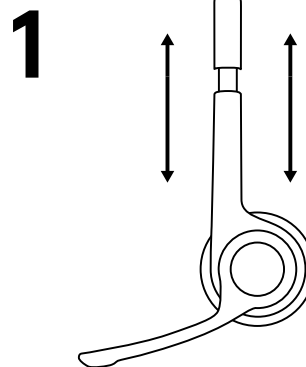

2

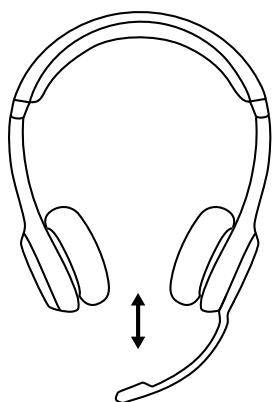

3

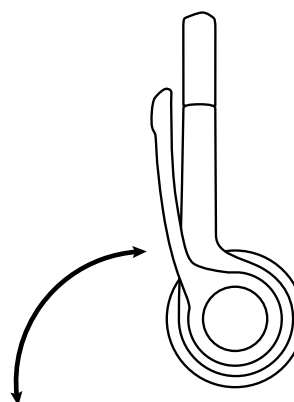

CONTROLLI

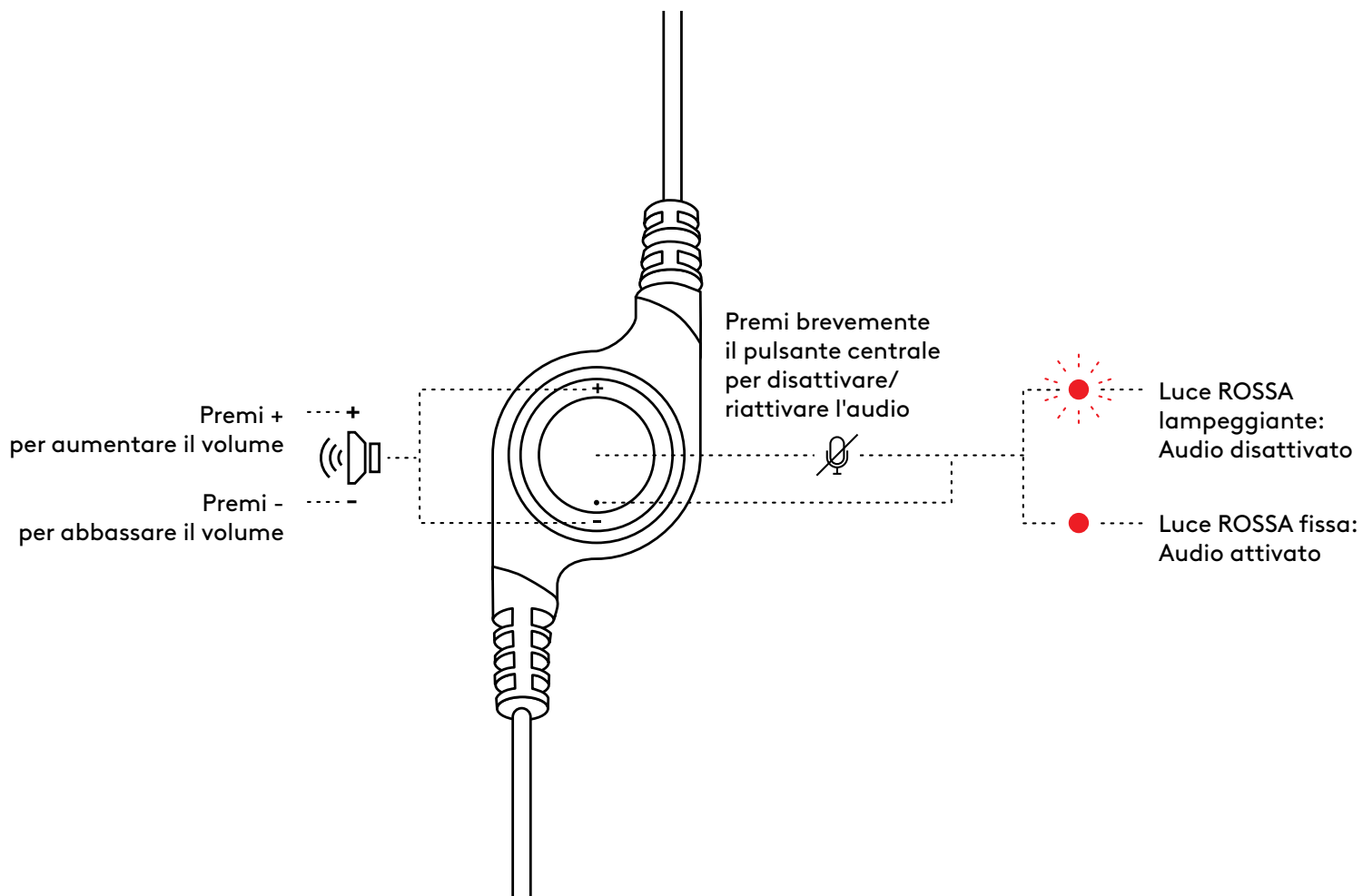

www.logitech.com/support/H390

COMPONENTES DEL PRODUCTO

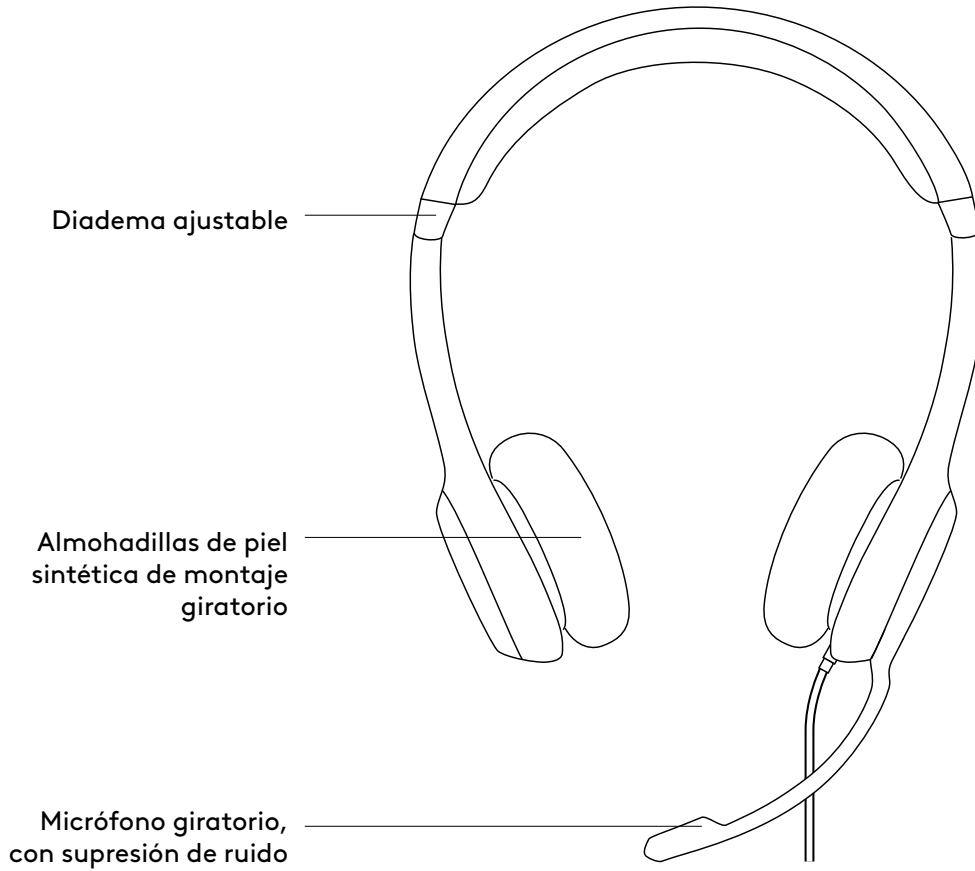

CONTROLADOR INTEGRADO EN EL CABLE

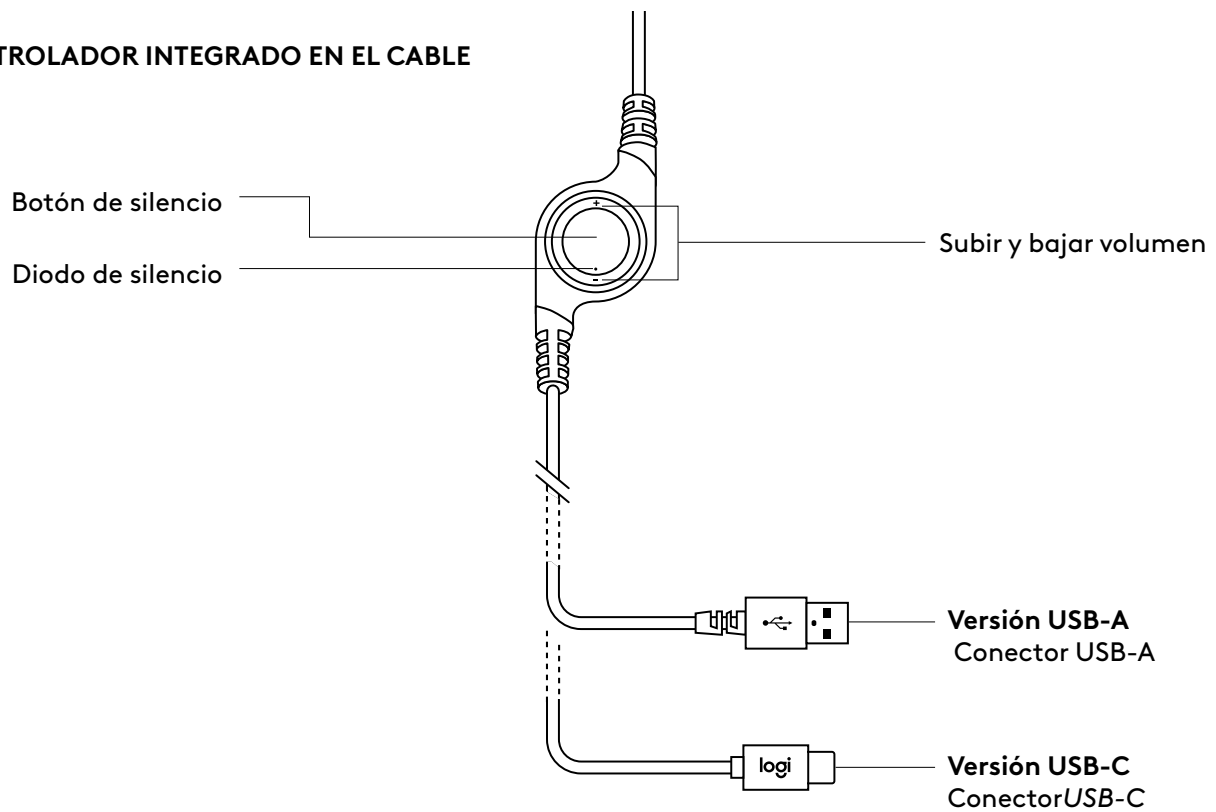

CONEXIÓN DE LOS AURICULARES

Conecta el conector USB al puerto USB del ordenador.

Versión USB-A

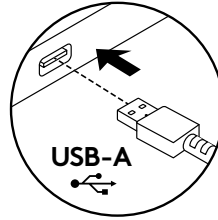

Versión USB-C

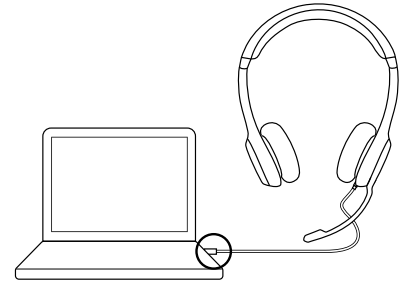
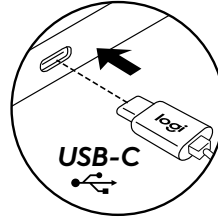

AJUSTE DE LOS AURICULARES

1. Para ajustar el tamaño de los auriculares, sube y baja la diadema hasta que te resulten cómodos.
2. Mueve la varilla del micrófono hacia arriba o hacia abajo hasta que esté al nivel de la boca para conseguir una mejor captura de voz.
3. La varilla se puede apartar mientras no se esté utilizando.

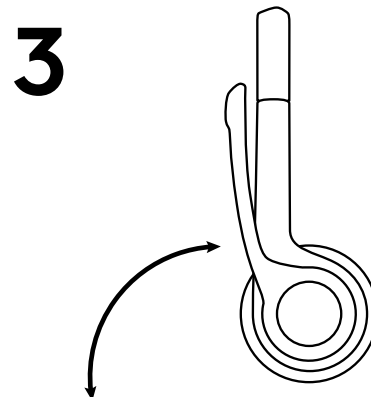
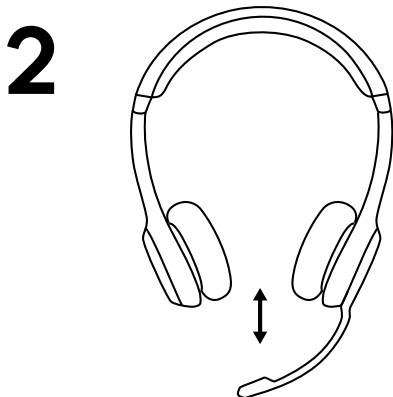
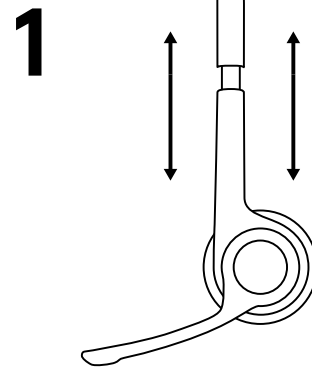

CONTROLES

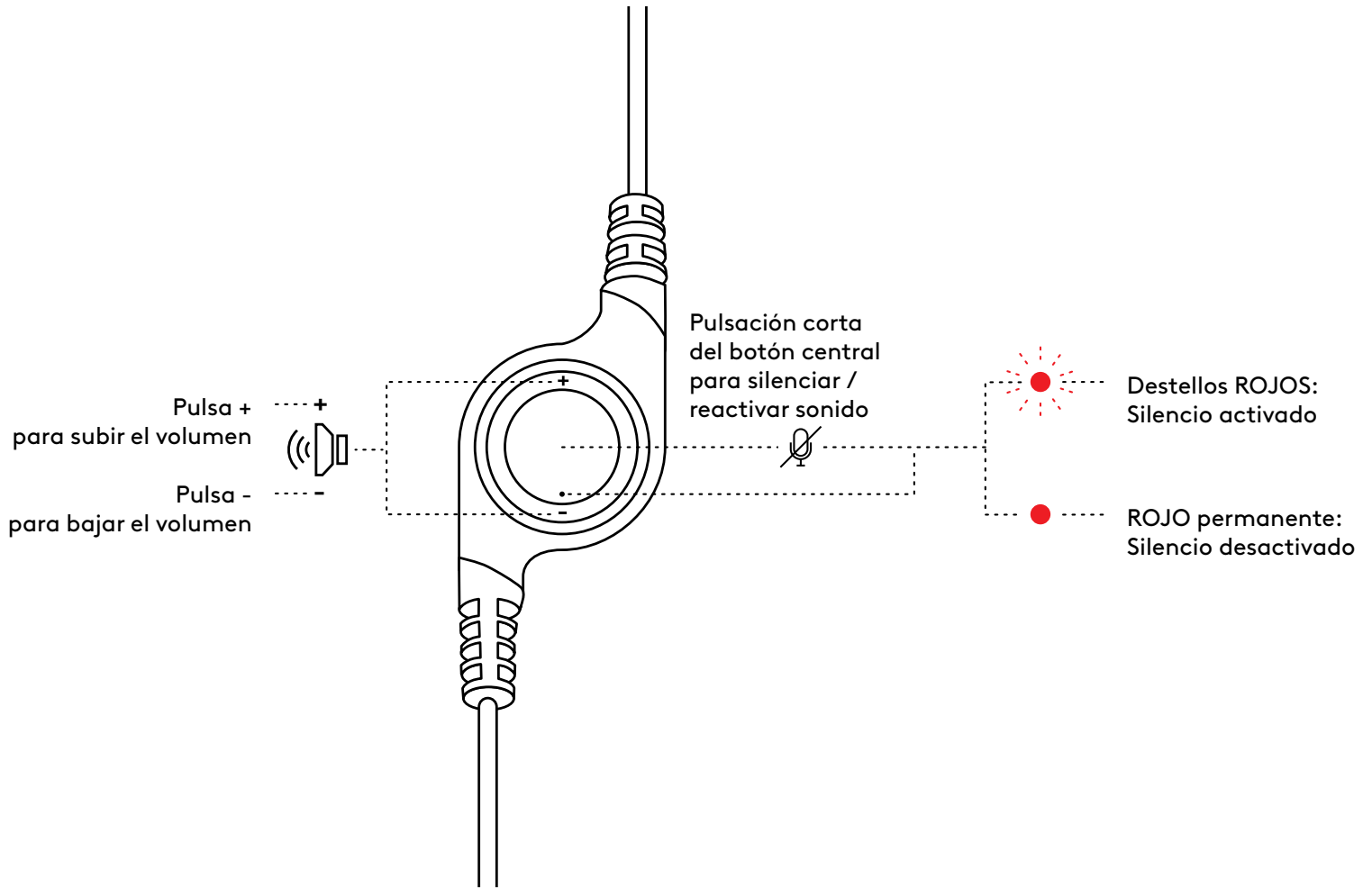

www.logitech.com/support/H390

CONHEÇA O SEU PRODUTO

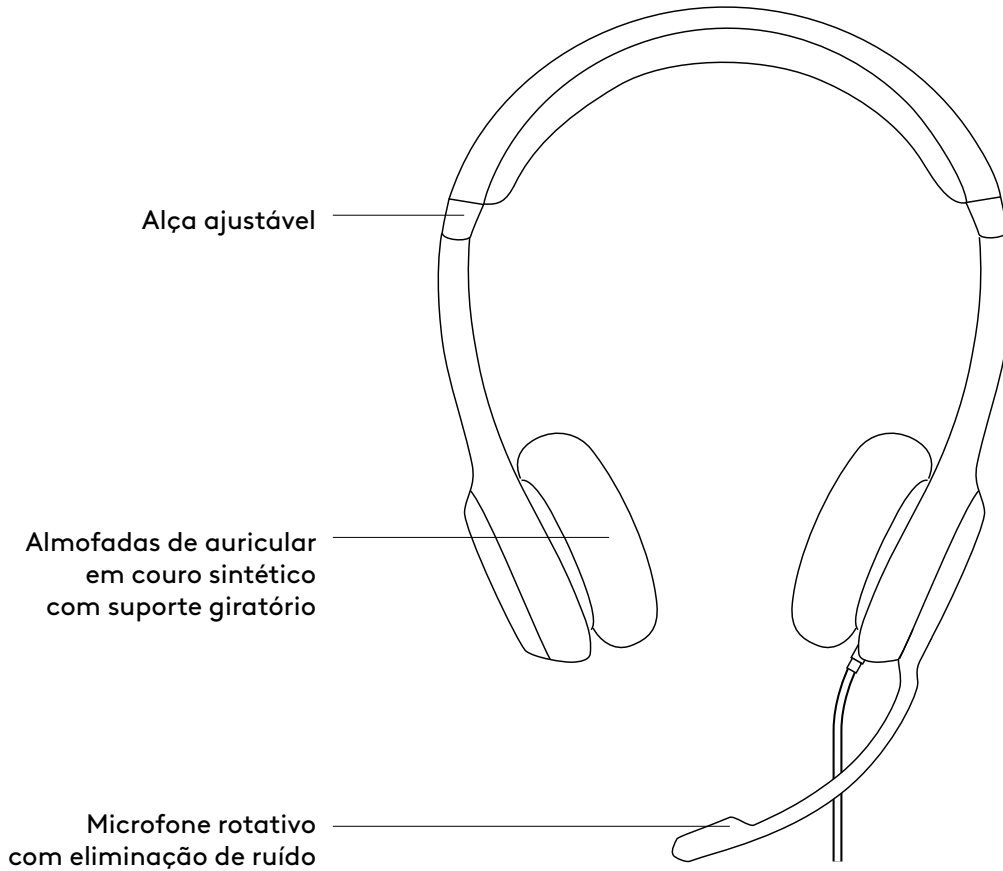

CONTROLADOR INTEGRADO

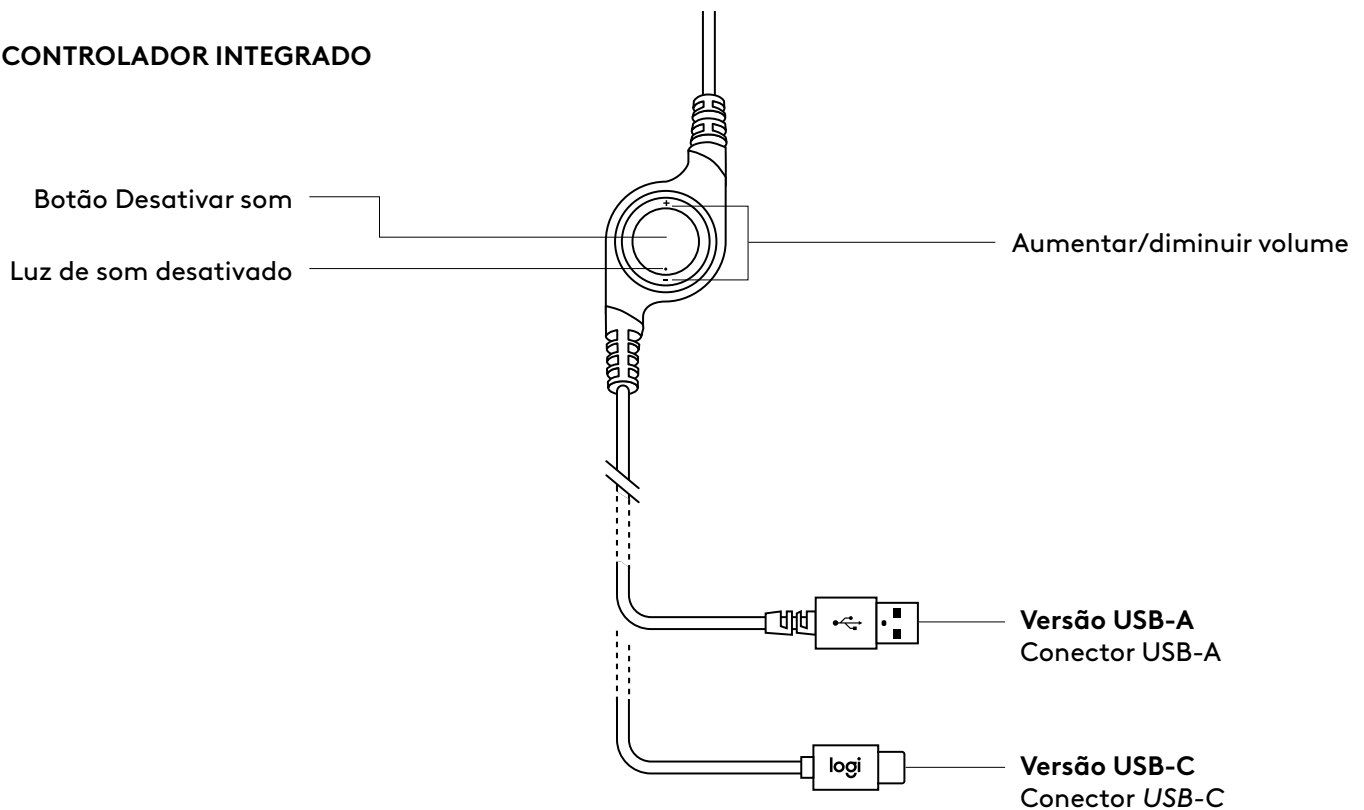

LIGAR OS AUSCULTADORES

Ligue o conector USB à porta USB do computador.

Versão USB-A

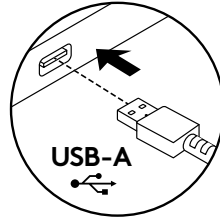

Versão USB-C

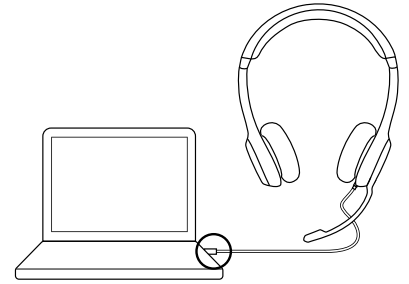
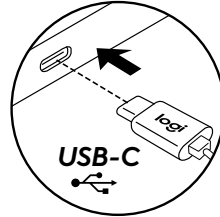

AJUSTE DOS AUSCULTADORES

1. Para ajustar o tamanho dos auscultadores, mova a alça para cima e para baixo até que esteja confortável.
2. Mova a haste do microfone para cima ou para baixo até que esteja nivelado com a sua boca para melhor captação da sua voz.
3. Pode afastar a haste quando não utilizar o microfone.

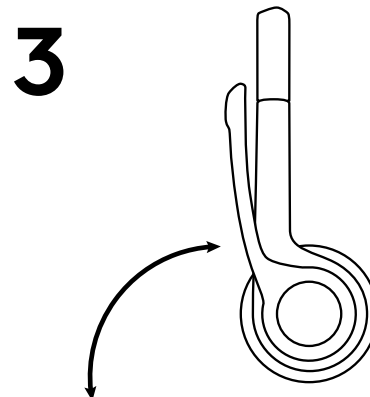
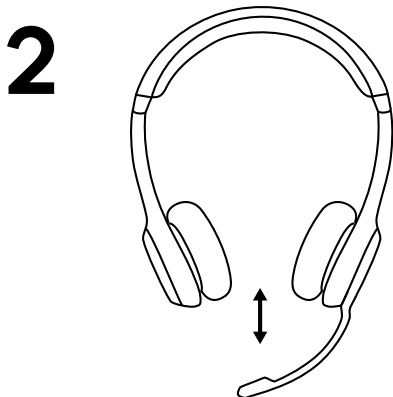
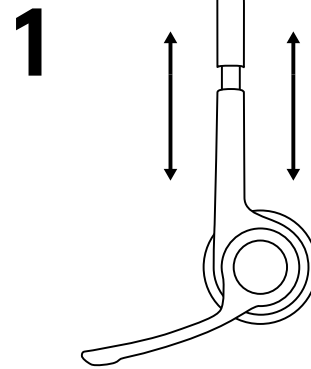

CONTROLOS

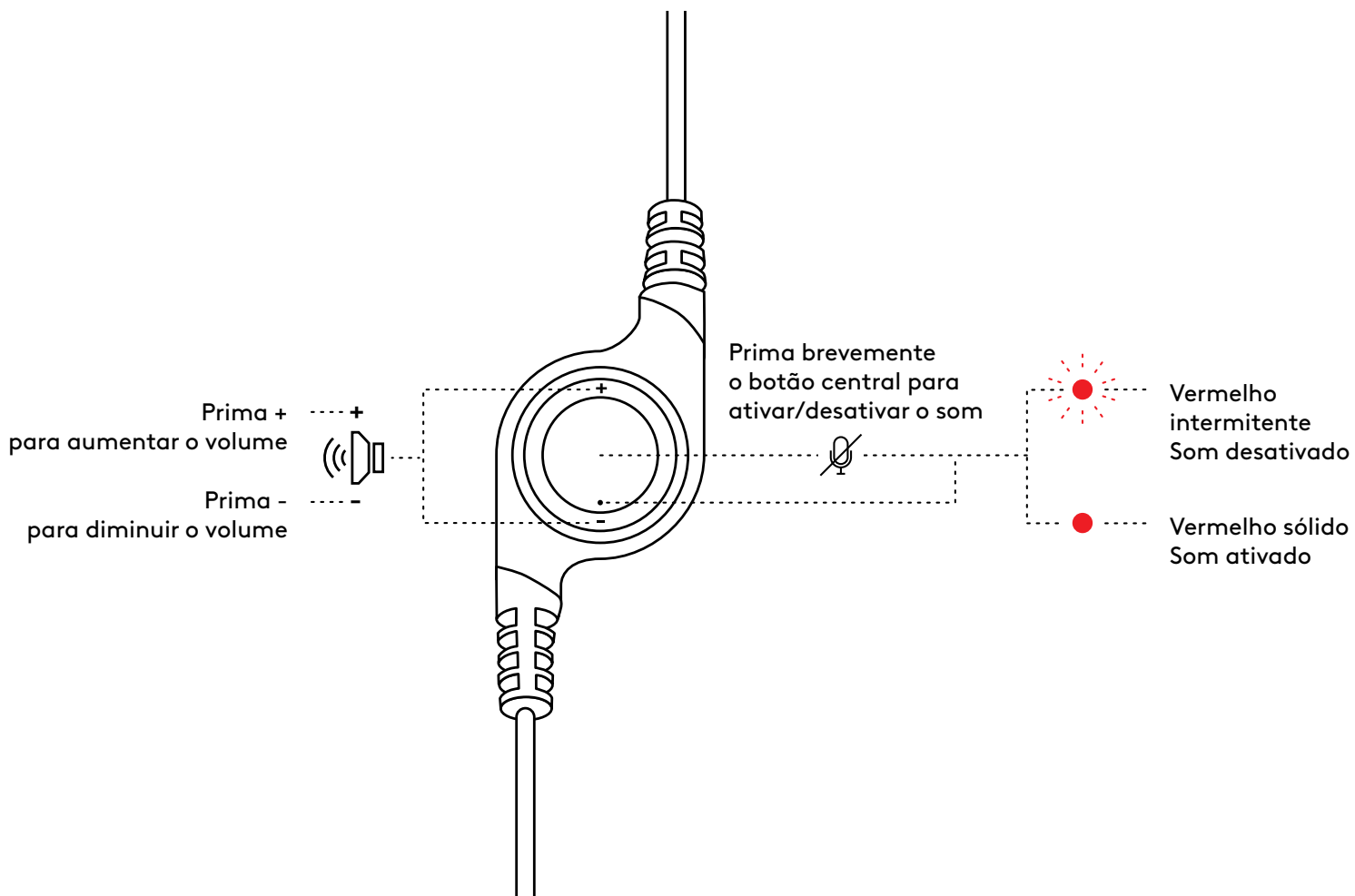

www.logitech.com/support/H390

KEN JE PRODUCT

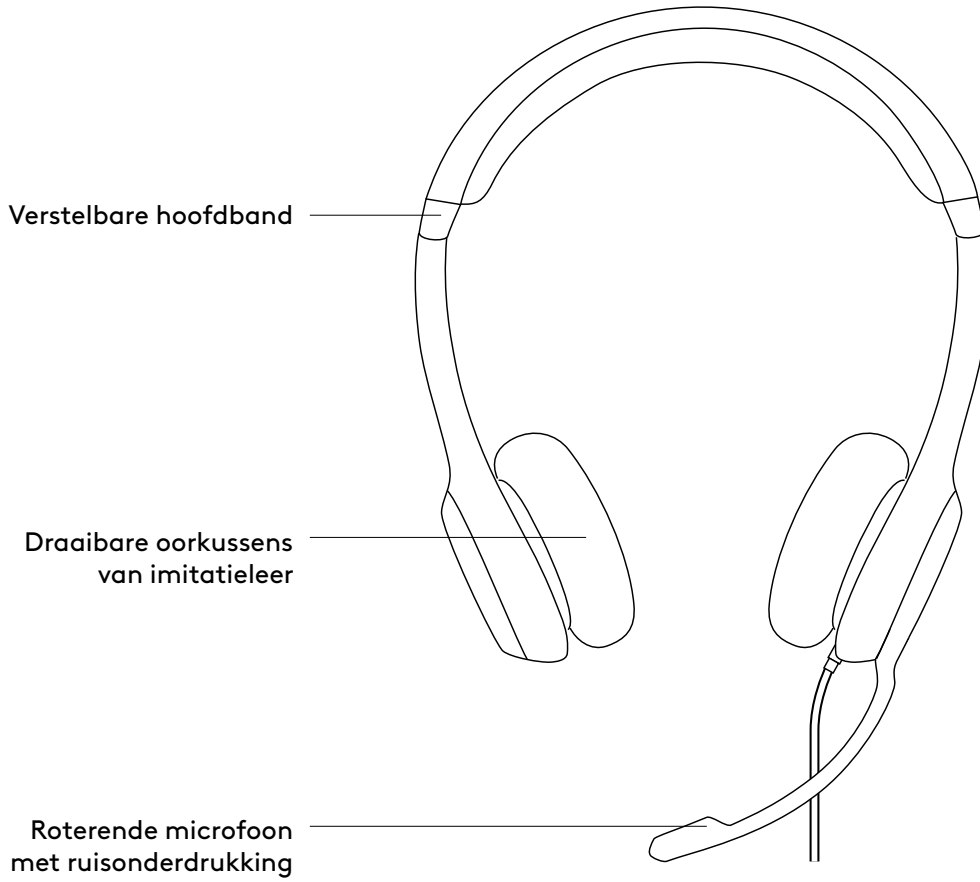

BEDIENING OP DE DRAAD

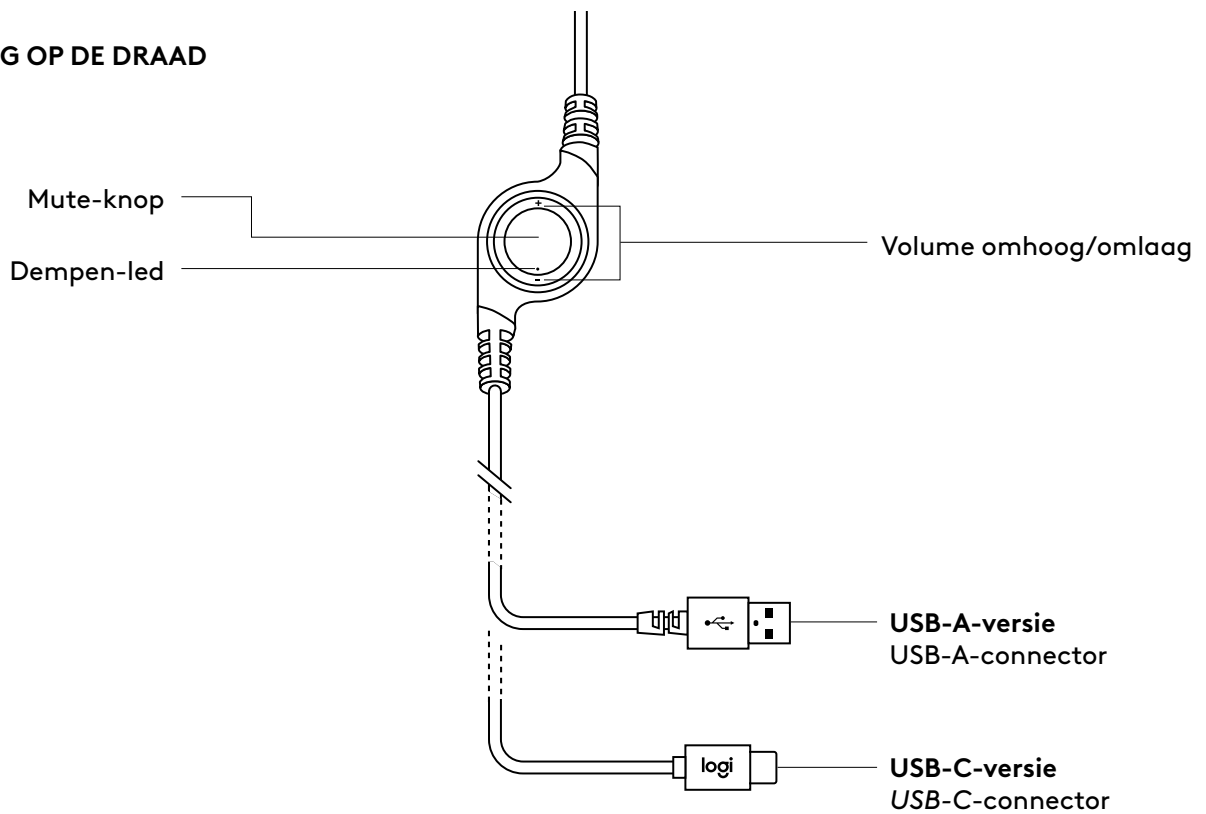

DE HEADSET AANSLUITEN

Sluit de USB-connector aan op de USB-poort van de computer.

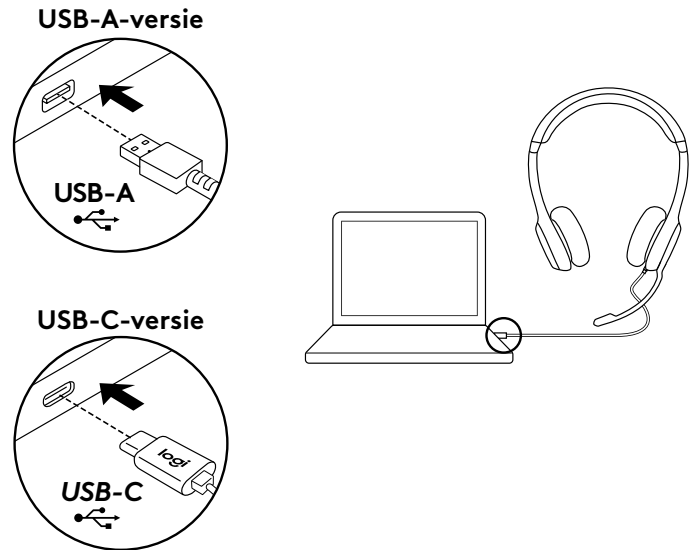

PASVORM VAN DE HEADSET

1. Pas de headset aan door de hoofdband omhoog en omlaag te bewegen tot deze comfortabel zit.
2. Beweeg de microfoonarm omhoog of omlaag tot deze voor je mond is voor betere stemopname.
3. De microfoon kan worden weggestopt wanneer je deze niet nodig hebt.

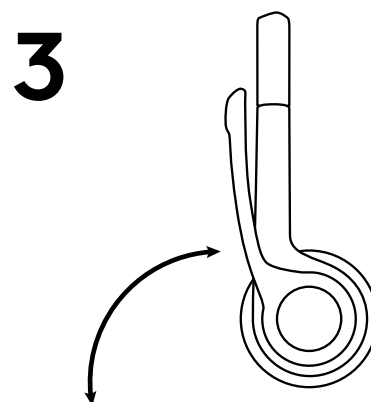
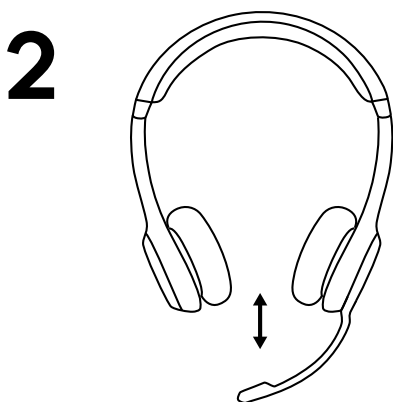
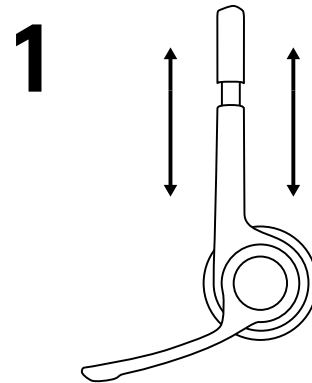

KNOPPEN

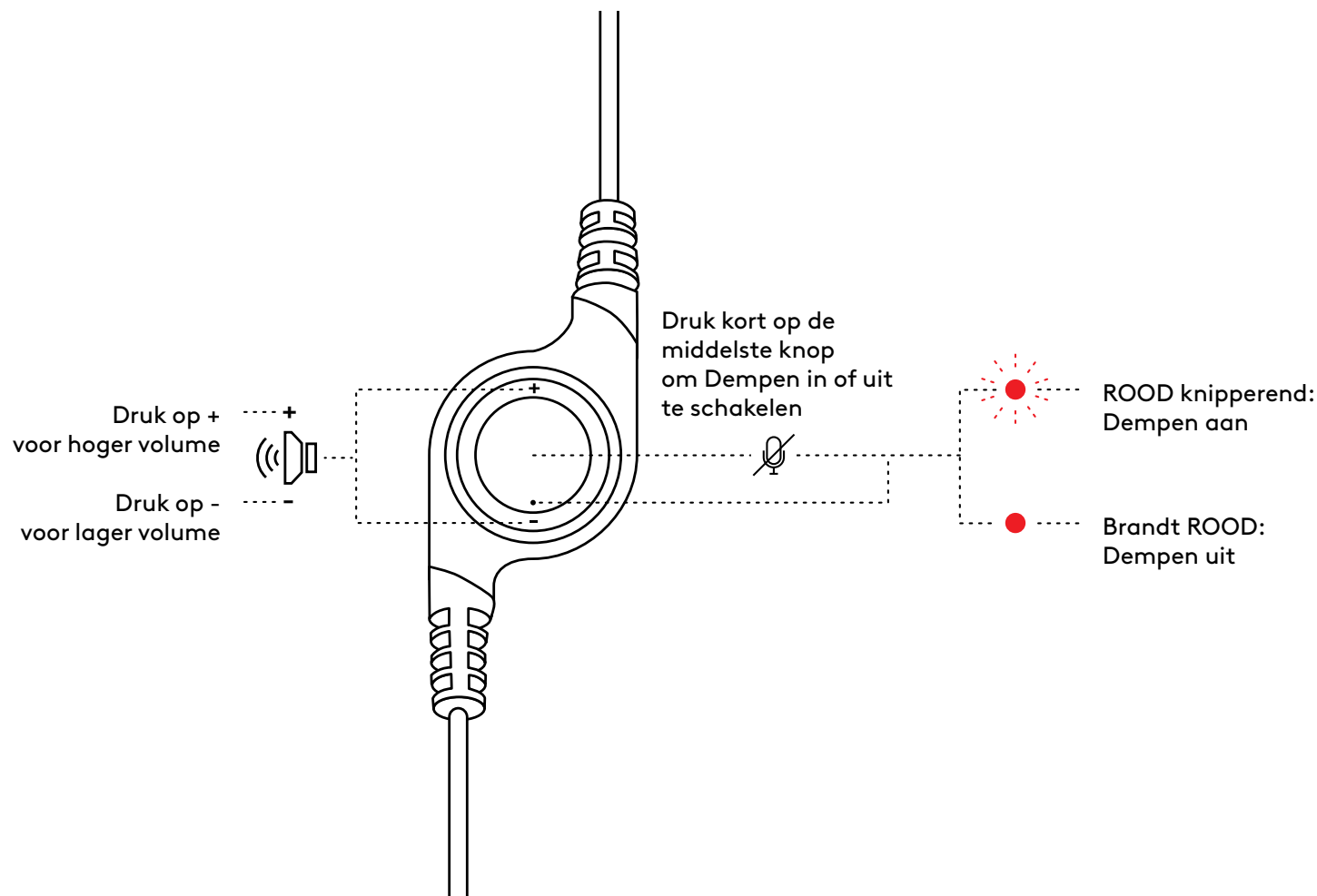

www.logitech.com/support/H390

PRODUKTÖVERSIKT

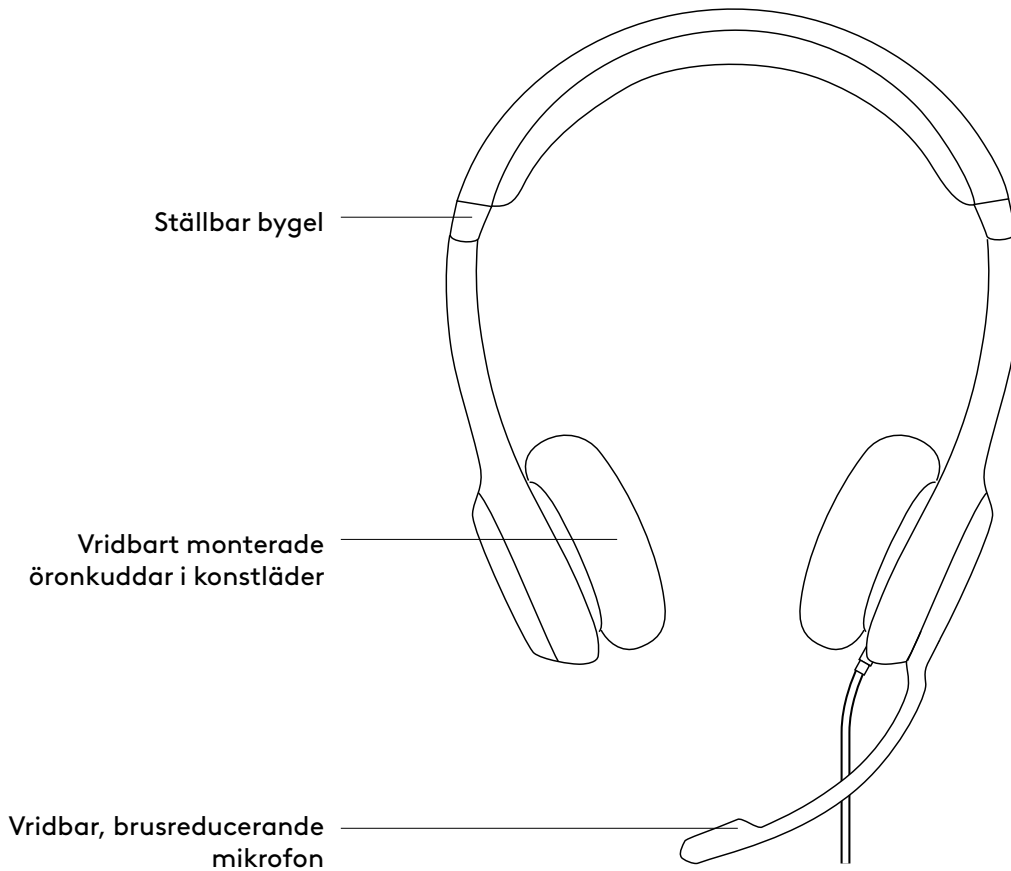

SLADDMONTERADE REGLAGE

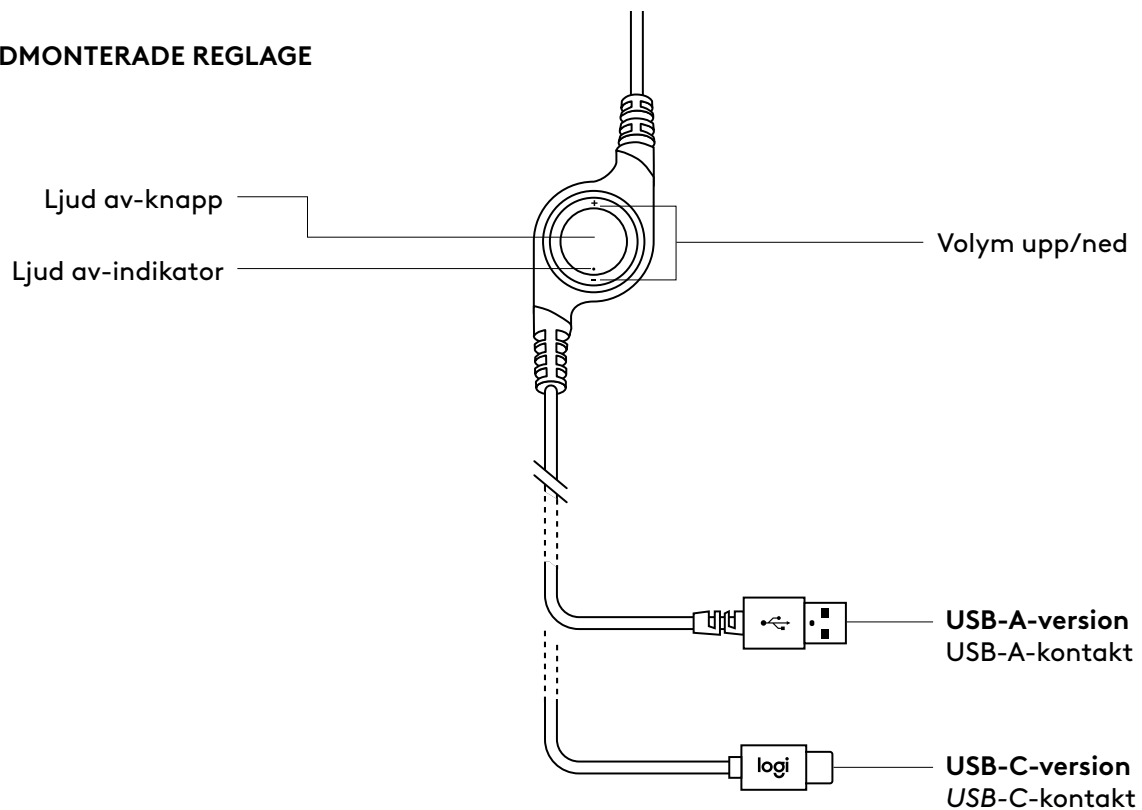

ANSLUTA HEADSETET

Anslut USB-kontakten till en USB-port på datorn.

USB-A-version

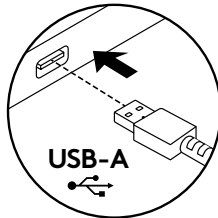

USB-C-version

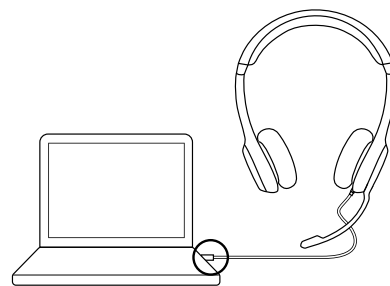
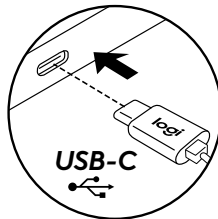

STÄLLA IN HEADSETET

1. Justera headsetets storlek genom att flytta bygeln upp och ner tills headsetet sitter bekvämt.
2. Flytta mikrofonen upp eller ner tills den är i höjd med munnen för bättre röstupptagning.
3. Mikrofonbommen kan flyttas ur vägen när den inte används.

1

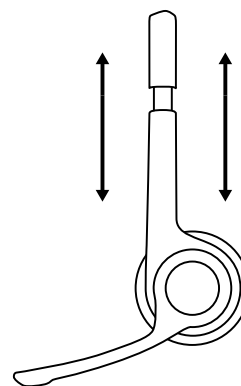

2

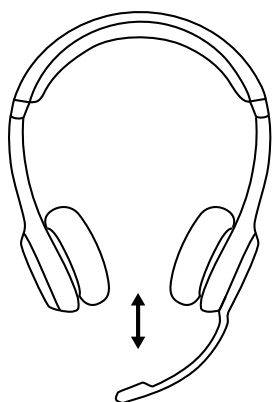

3

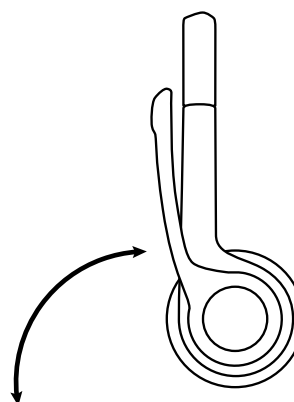

REGLAGE

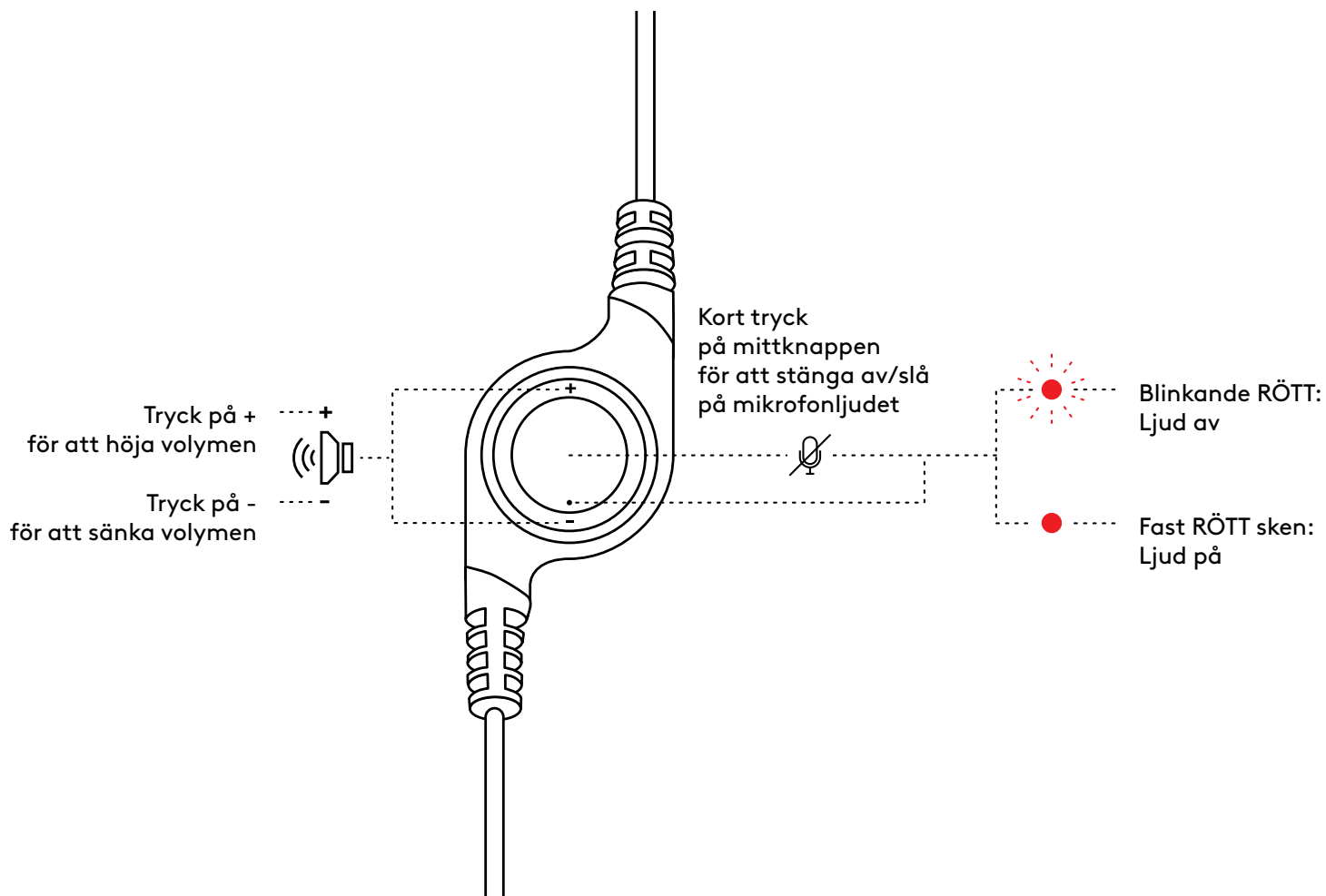

www.logitech.com/support/H390

OVERSIGT OVER PRODUKTET

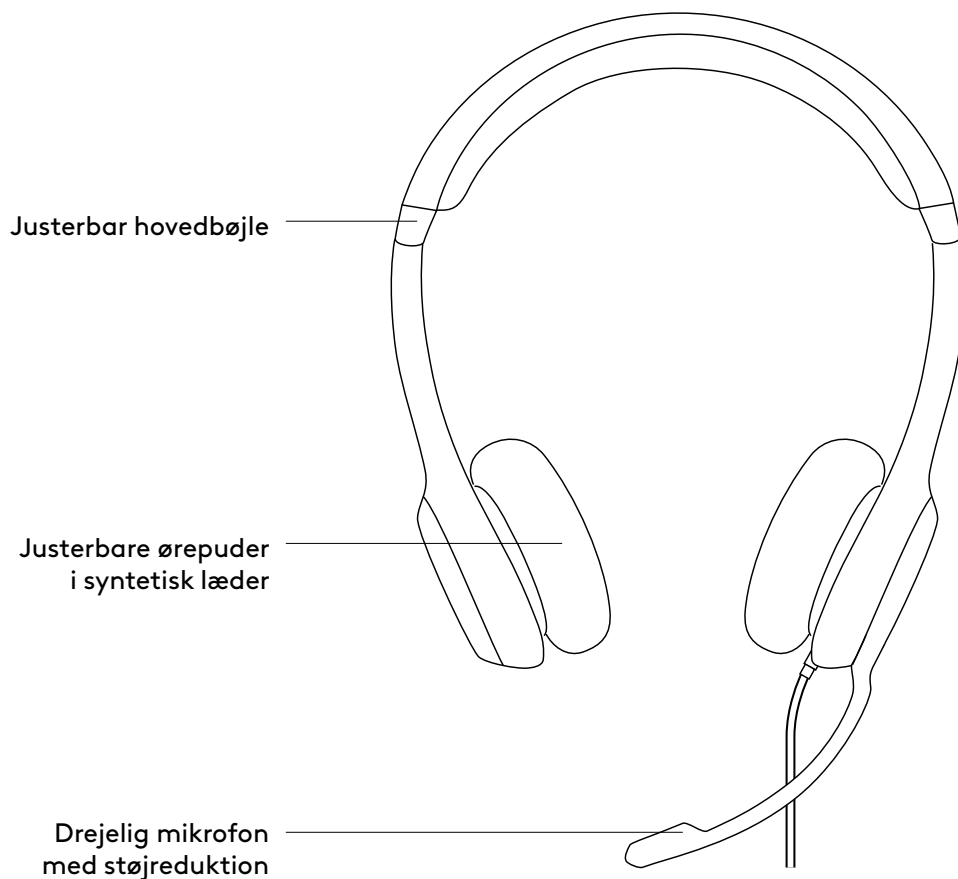

KONTROLKNAPPER PÅ LEDNINGEN

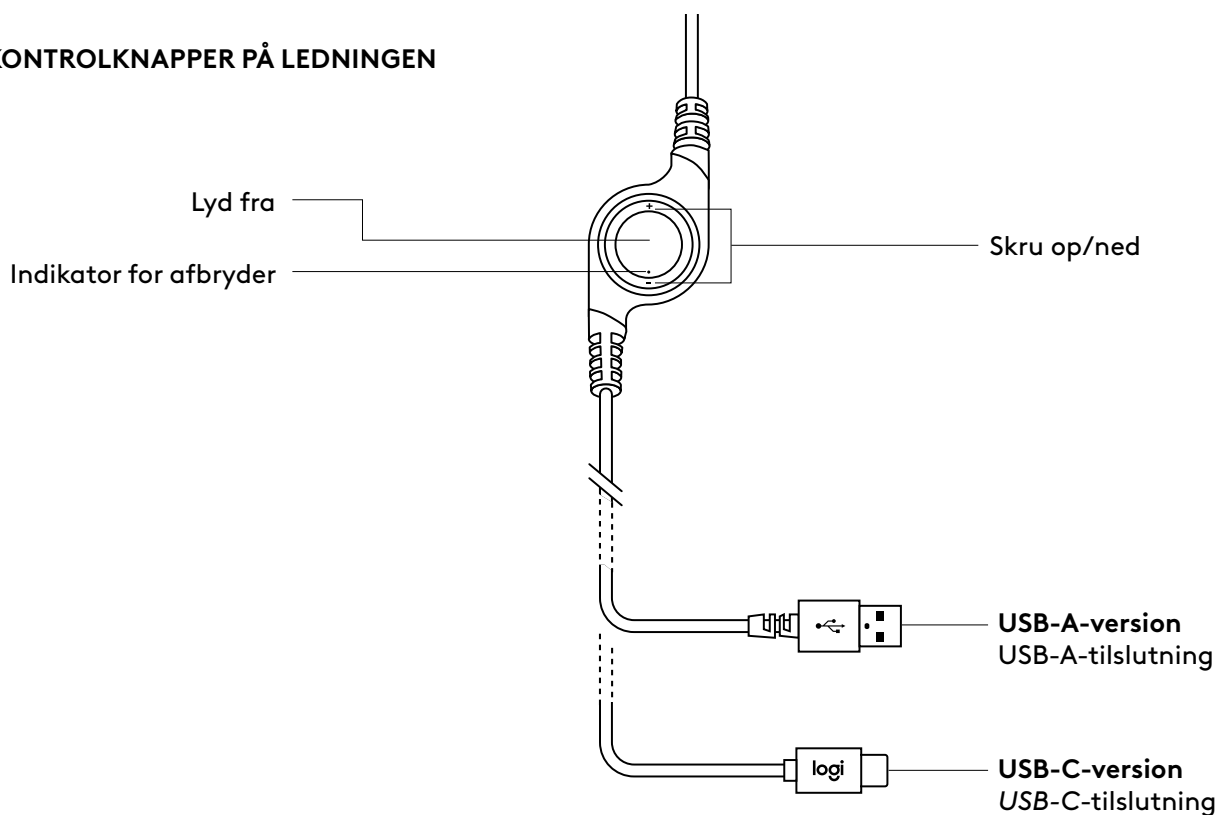

TILSLUTNING AF HEADSETTET

Slut USB-tilslutningen til en USB-port på computeren.

USB-A-version

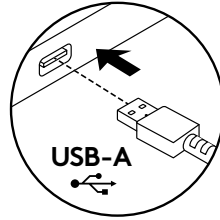

USB-C-version

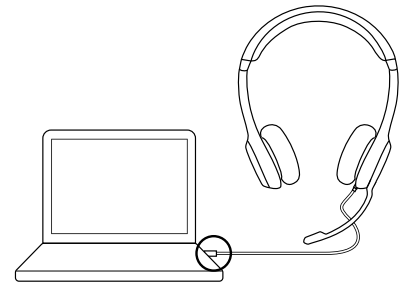
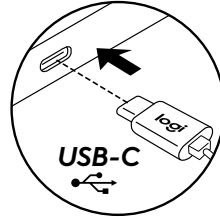

TILPASNING AF HEADSETTET

1. Headsettet justeres i størrelsen ved at flytte hovedbøjlen op og ned, til det føles behageligt.
2. Flyt mikrofonarmen op eller ned, indtil den er ud for munden, så du får den bedste lyd.
3. Mikrofonarmen kan gemmes af vejen når du ikke bruger mikrofonen.

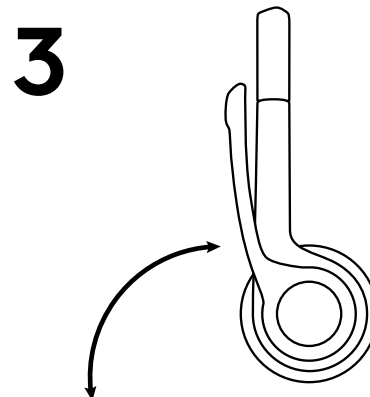
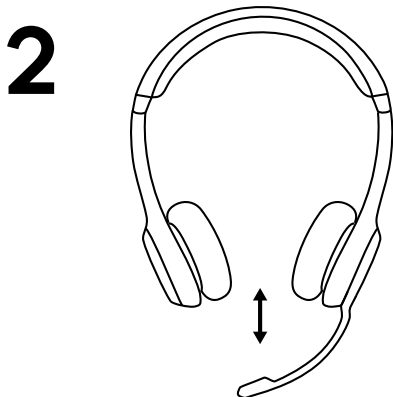
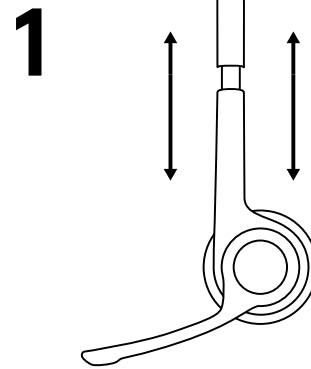

KONTROLKNAPPER

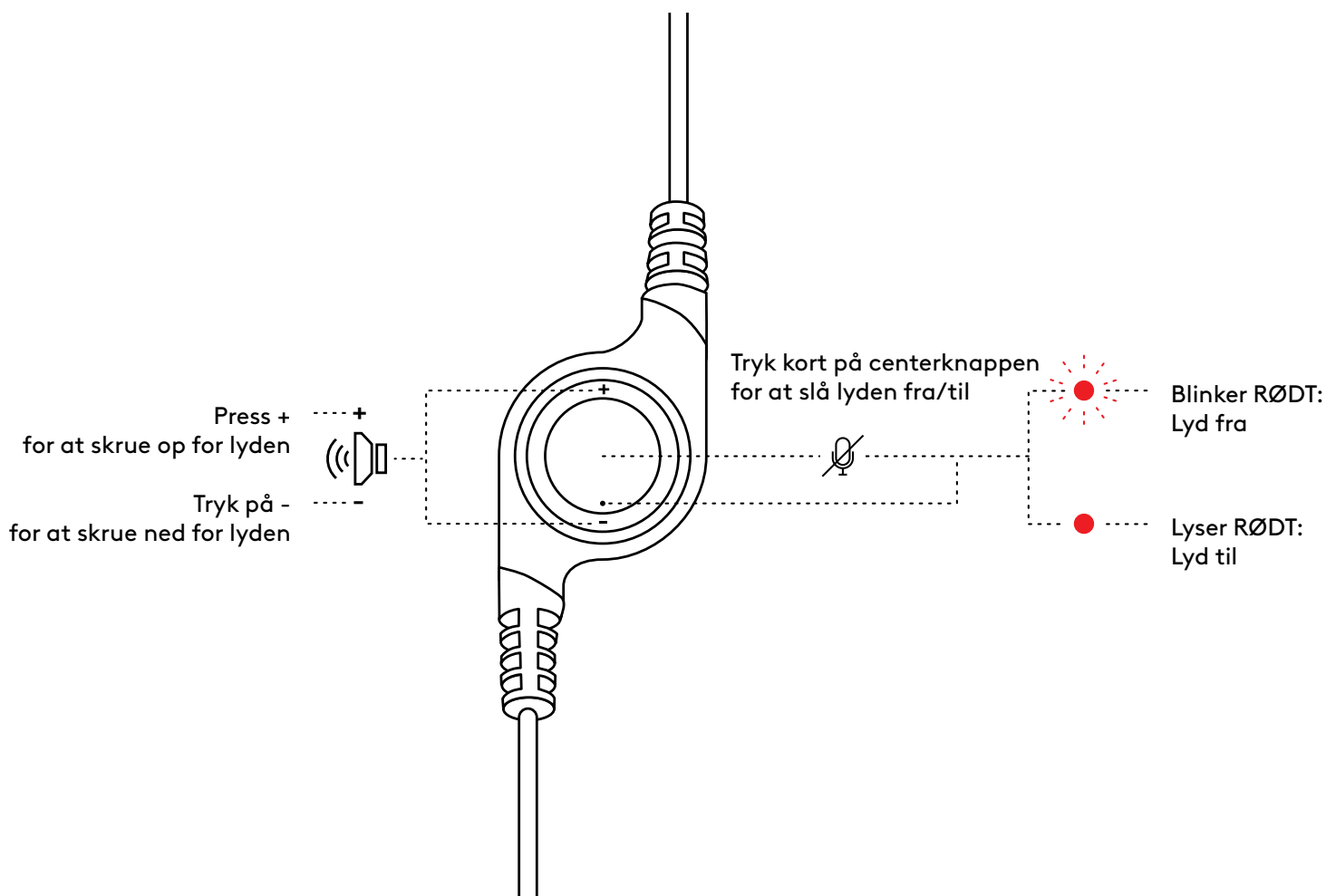

www.logitech.com/support/H390

BLI KJENT MED PRODUKTET

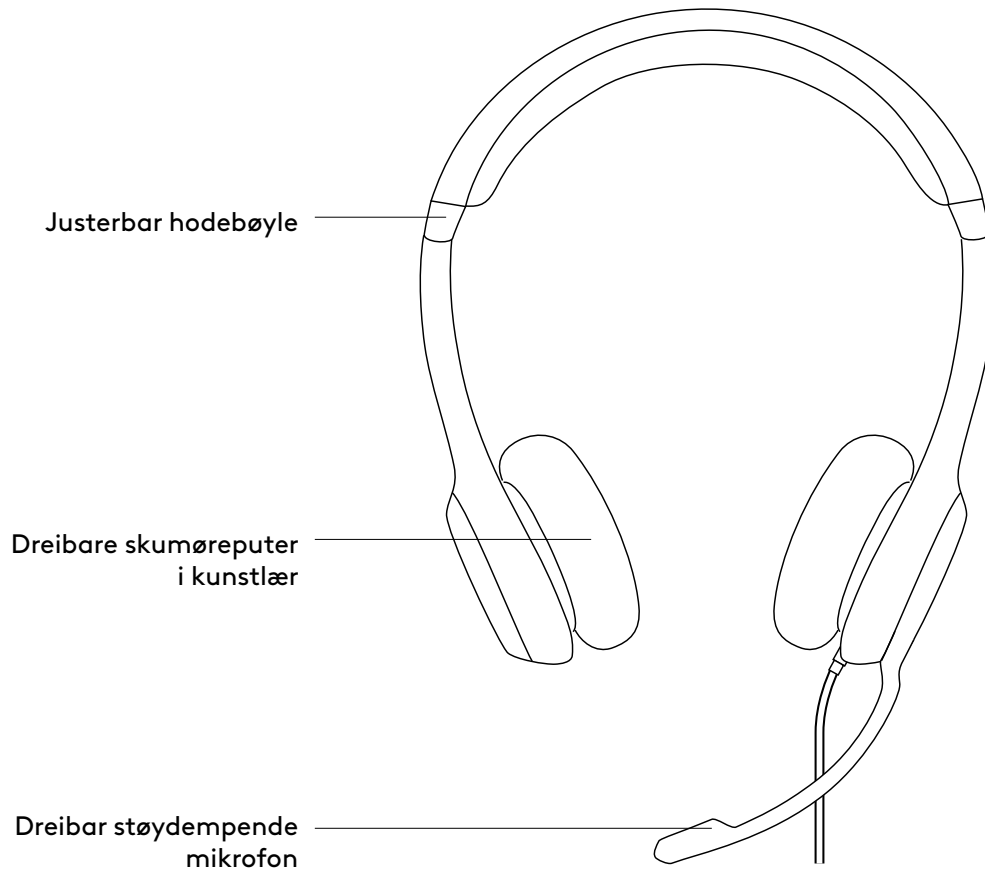

INTEGRERTE KONTROLLER PÅ LEDNINGEN

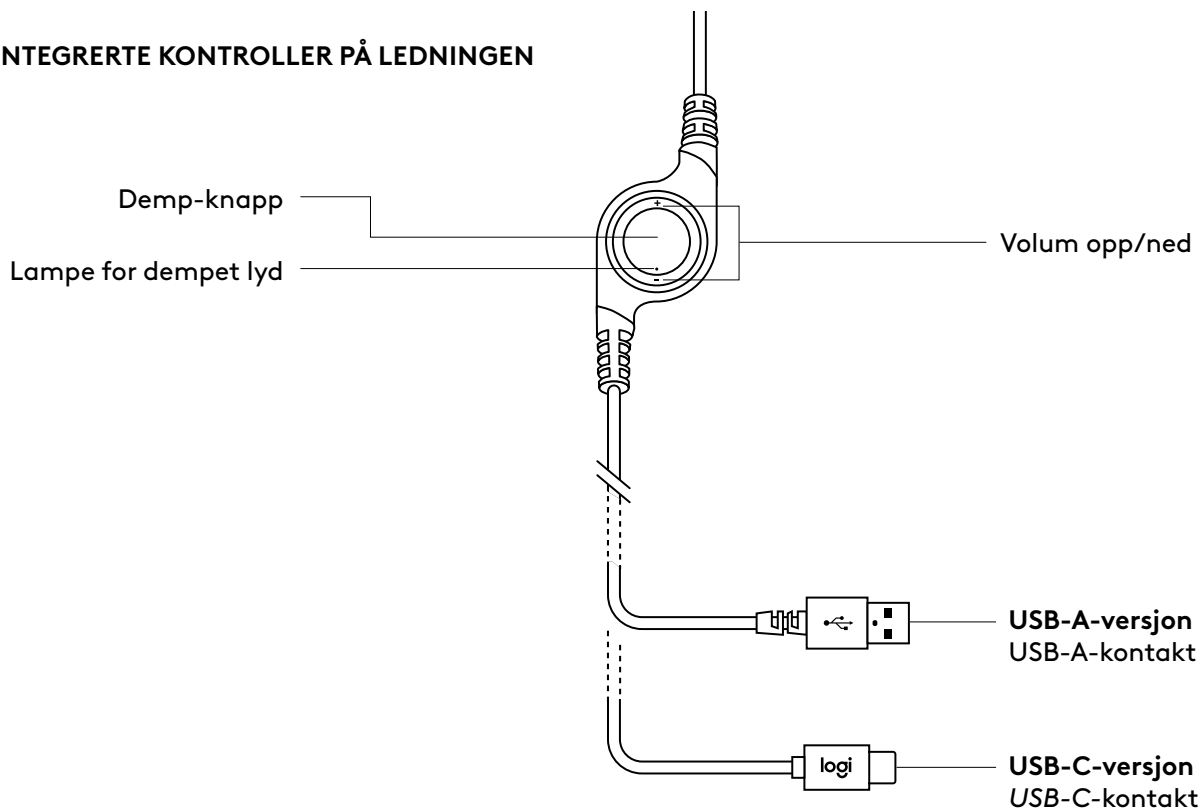

KOBLE TIL HEADSETTET

Koble USB-kontakten til en USB-port på datamaskinen.

USB-A-versjon

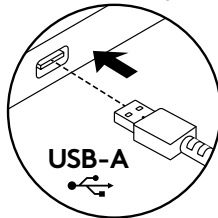

USB-C-versjon

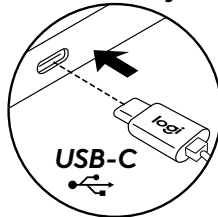

JUSTERE HEADSETTET

1. Juster headset-størrelsen ved å flytte hodebøylen opp og ned til den sitter behagelig.
2. Flytt mikrofonarmen opp eller ned og inn eller ut til den er på samme nivå som munnen for å gjøre det enklere å fange opp stemmen din.
3. Telefonarmen kan skyves unna når du ikke bruker den.

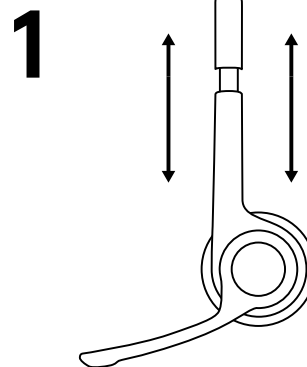

2

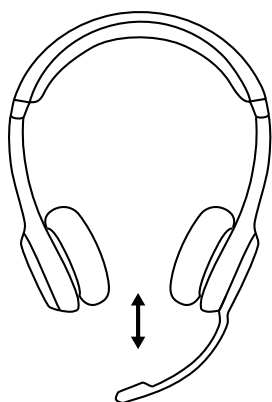

3

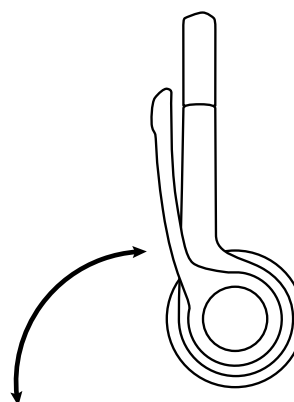

KONTROLLERE

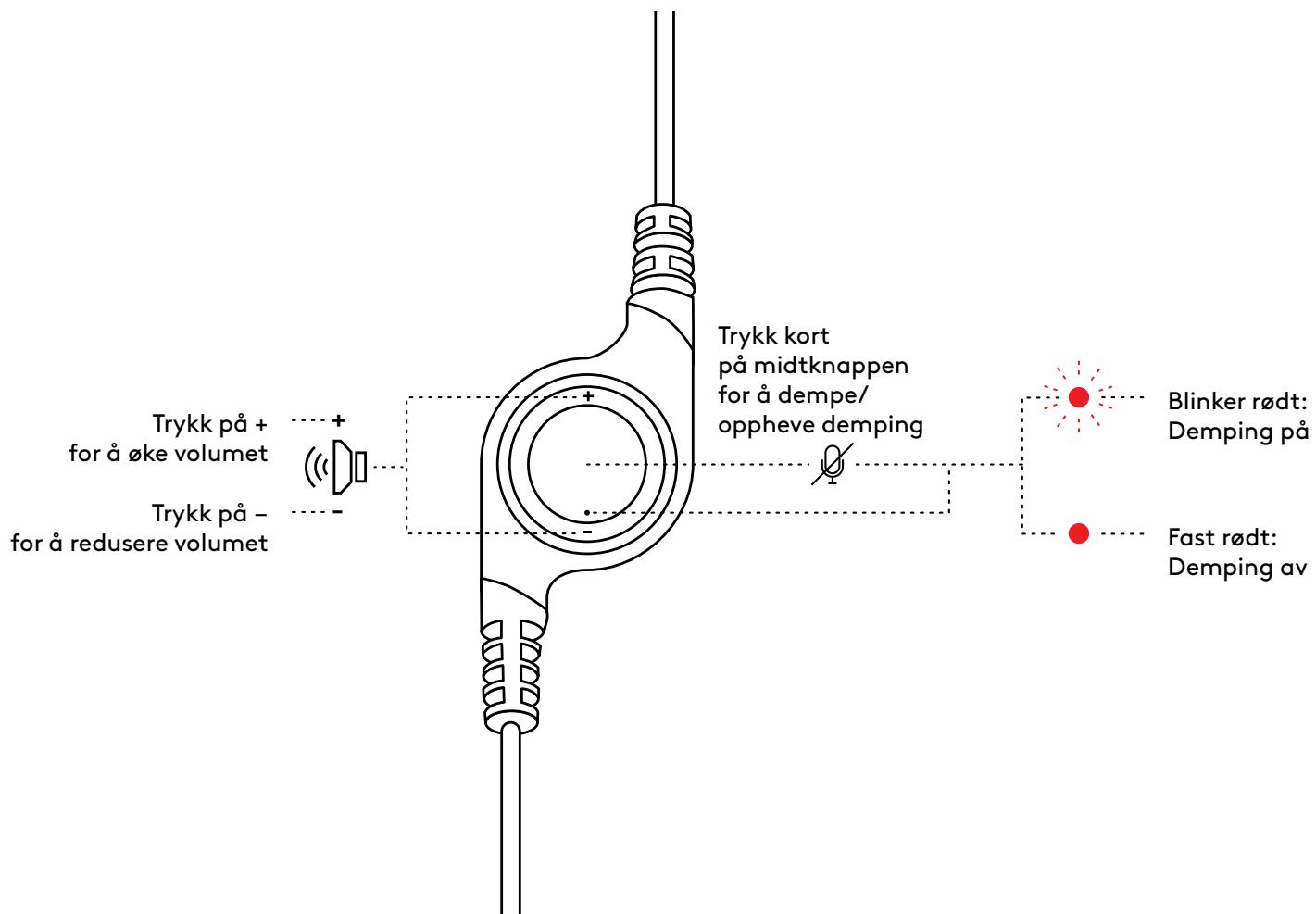

www.logitech.com/support/H390

TUNNE TUOTTEESI

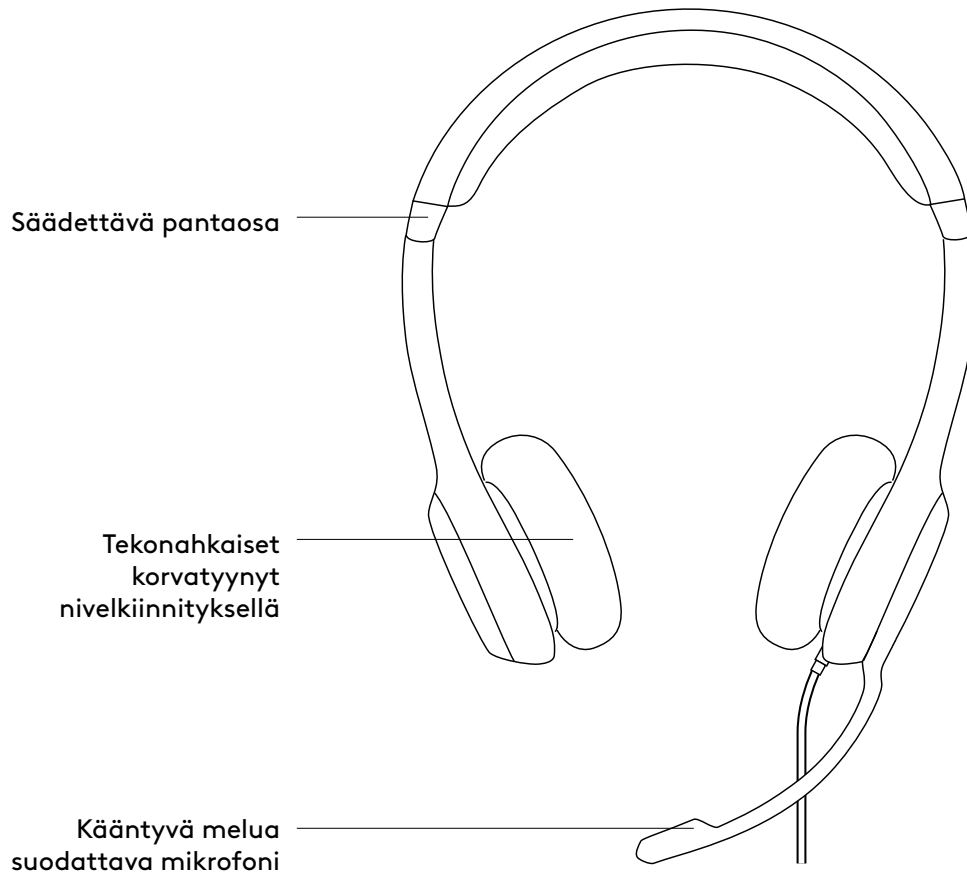

JOHDOSSA OLEVAT OHJAUSPAINIKKEET

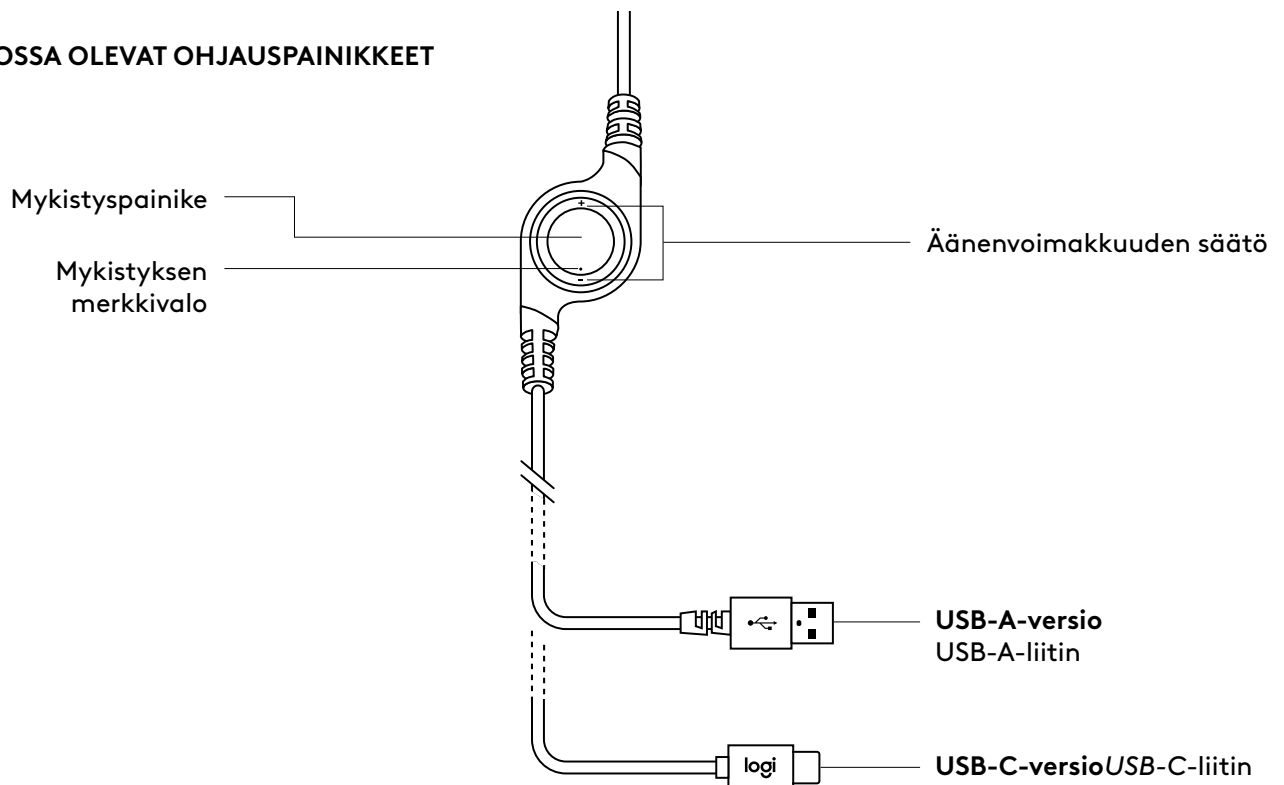

KUULOKEMIKROFONIN LIITTÄMINEN

Kytke USB-liitin tietokoneen USB-porttiin.

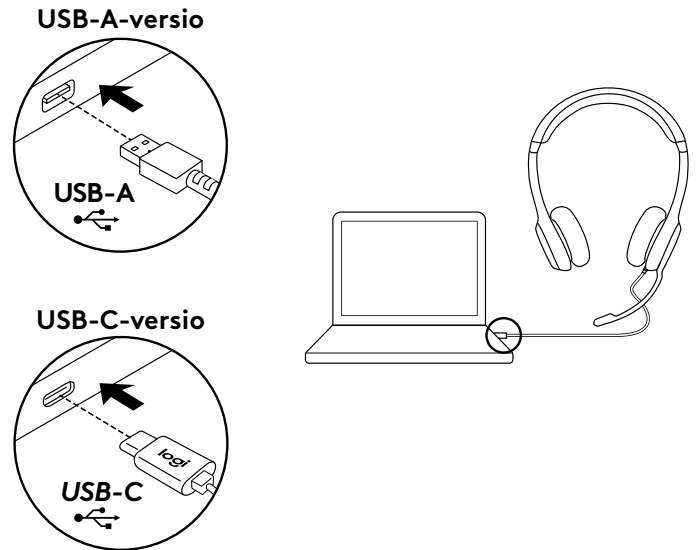

KUULOKEMIKROFONIN ISTUVUUS

1. Säädä kuulokkeen kokoa siirtämällä pantaosaa ylös ja alas, kunnes se istuu mukavasti.
2. Liikuta mikrofonin vartta äänenlaadun parantamiseksi ylös- tai alaspäin, kunnes mikrofoni on suusi tasolla.
3. Mikrofonivarsi voidaan painaa pois tieltä, kun sitä ei tarvita.

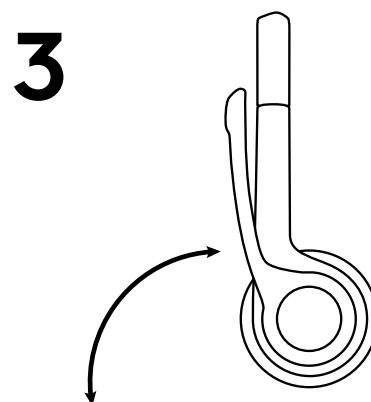
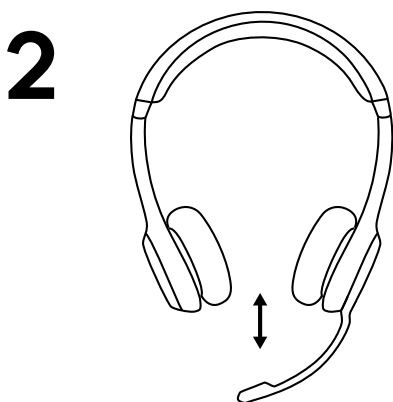
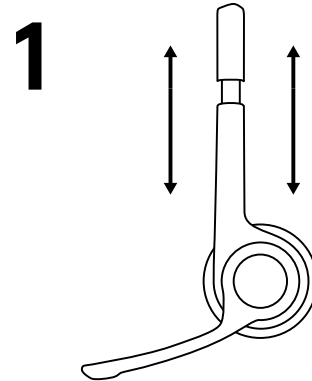

SÄÄTIMET

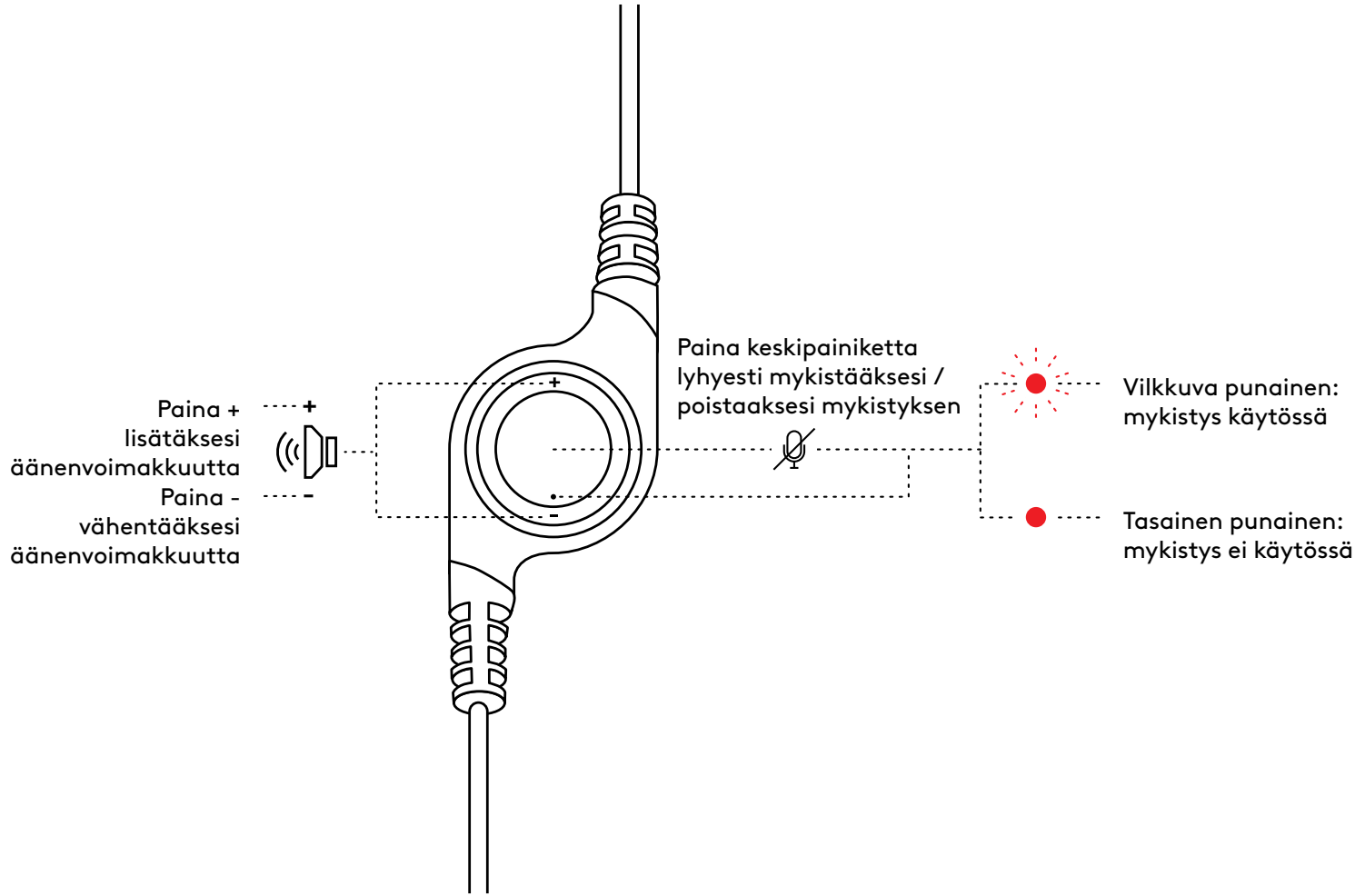

www.logitech.com/support/H390

ΓΝΩΡΙΣΤΕ ΤΟ ΠΡΟΪΟΝ



ΧΕΙΡΙΣΤΗΡΙΟ ΣΤΟ ΚΑΛΩΔΙΟ

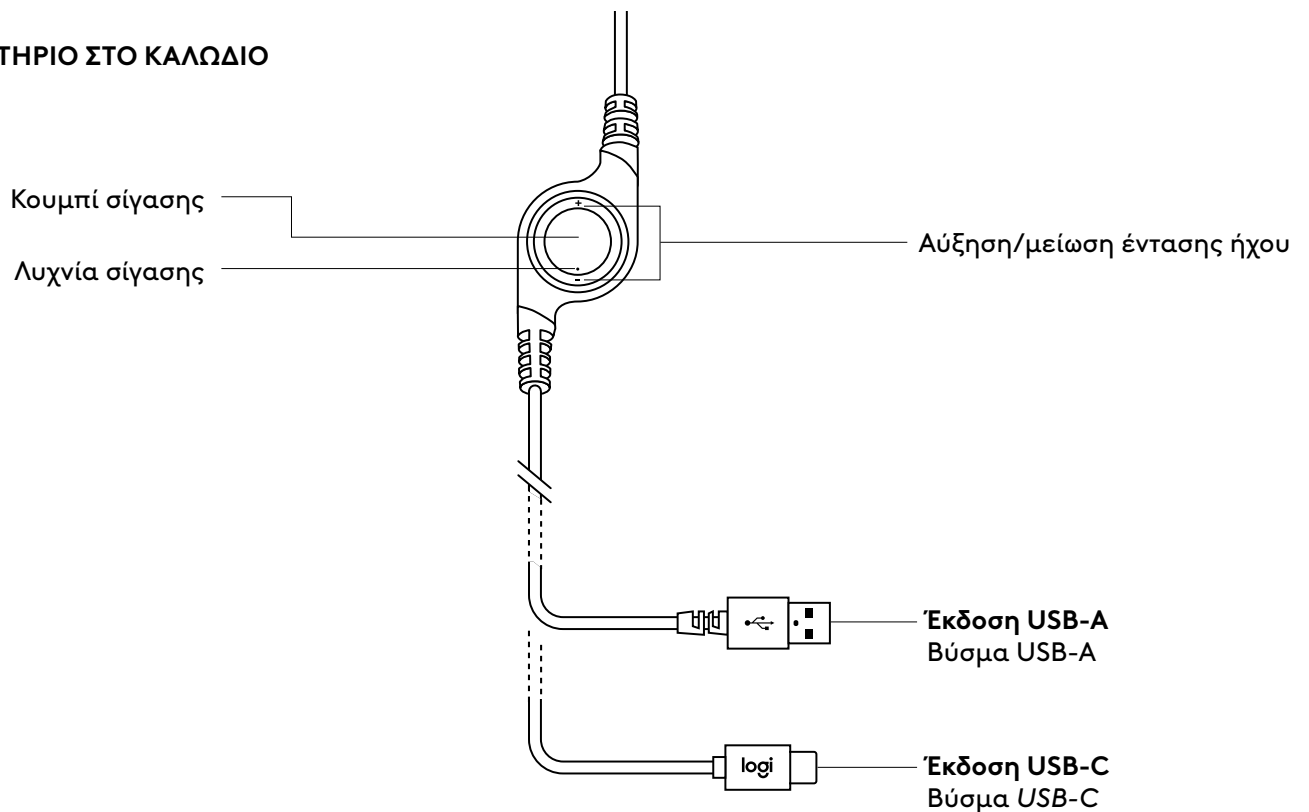

ΣΥΝΔΕΣΗ ΤΟΥ ΣΕΤ ΜΙΚΡΟΦΩΝΟΥ-ΑΚΟΥΣΤΙΚΩΝ

Συνδέστε το βύσμα USB στην θύρα USB του υπολογιστή.

Έκδοση USB-A

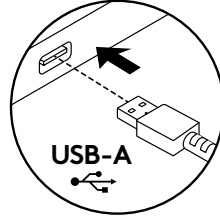

Έκδοση USB-C

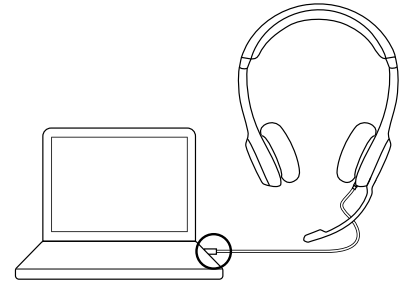
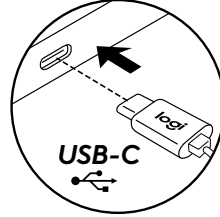

ΕΦΑΡΜΟΓΗ ΣΕΤ ΜΙΚΡΟΦΩΝΟΥ-ΑΚΟΥΣΤΙΚΩΝ

1. Για να προσαρμόσετε το μέγεθος του σετ μικροφώνου-ακουστικών, μετακινήστε το στήριγμα κεφαλής προς τα επάνω και προς τα κάτω μέχρι να εφαρμόσει άνετα στο κεφάλι σας.
2. Μετακινήστε τον βραχίονα του μικροφώνου προς τα επάνω ή προς τα κάτω μέχρι να το ευθυγραμμίσετε με το στόμα σας για να καταγράφει καλύτερα τη φωνή σας.
3. Το μικρόφωνο μπορεί να μετακινηθεί για να μην ενοχλεί όταν δεν χρησιμοποιείται.

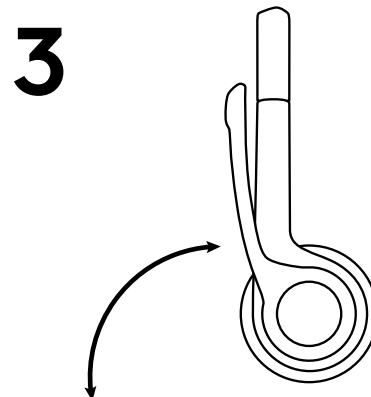
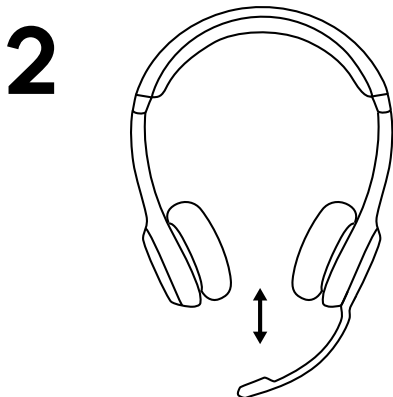
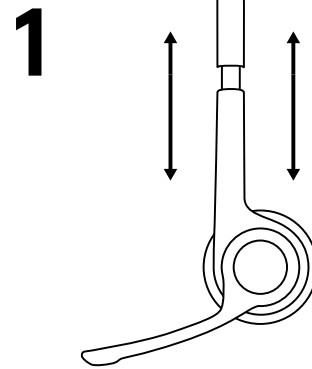

ΚΟΥΜΠΙΑ ΕΛΕΓΧΟΥ

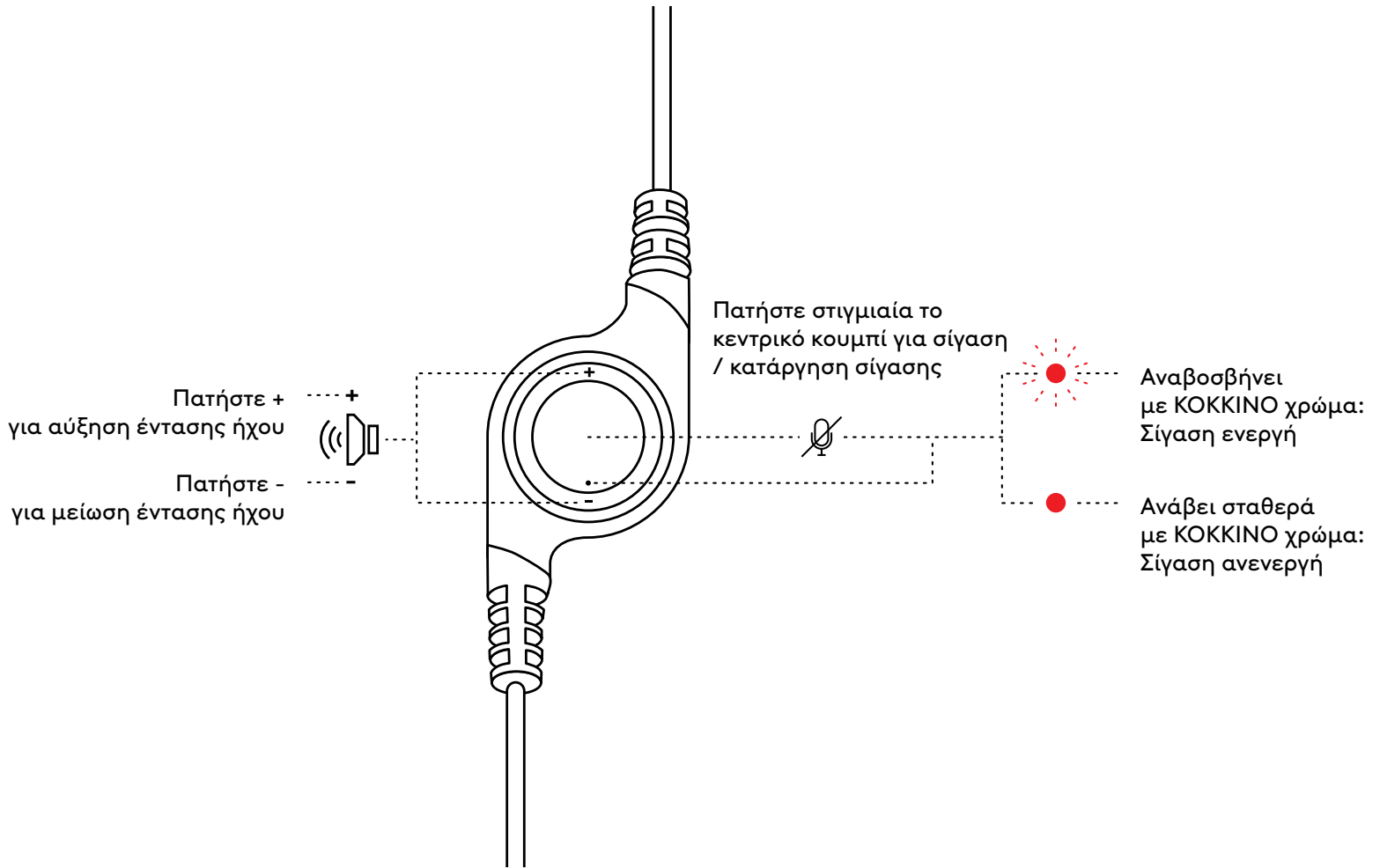

www.logitech.com/support/H390

ЗНАКОМСТВО С ПРОДУКТОМ

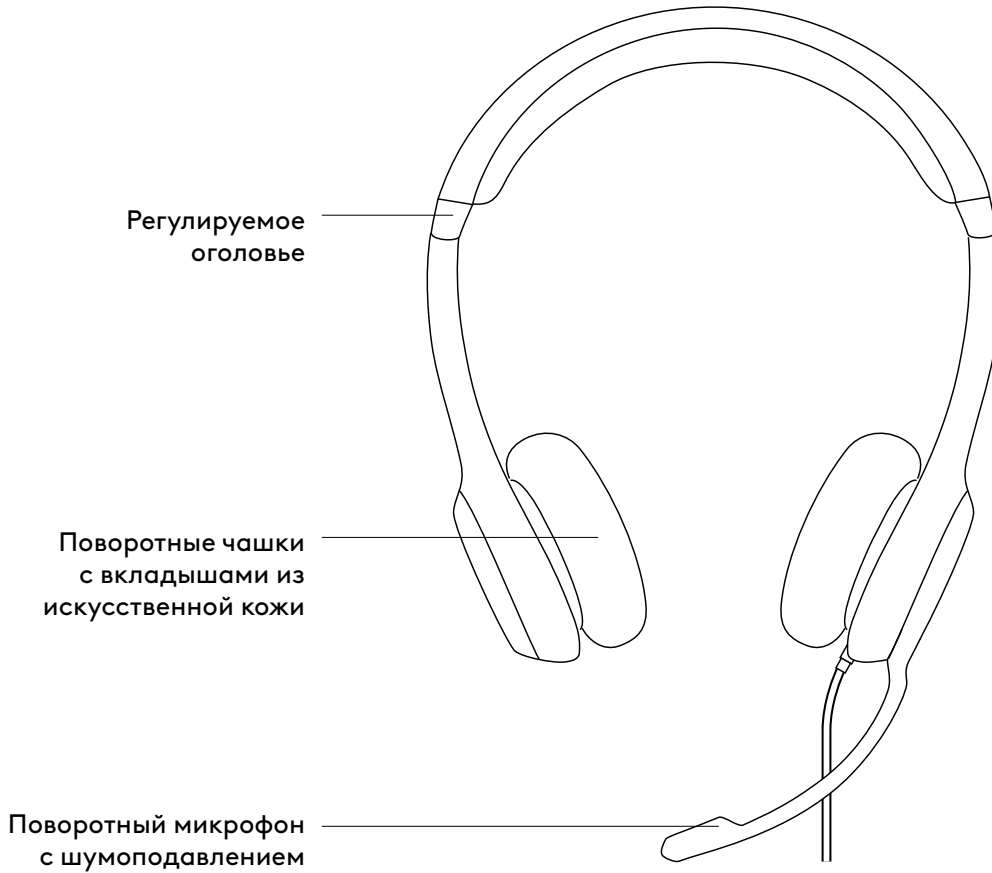

ВСТРОЕННЫЙ КОНТРОЛЛЕР

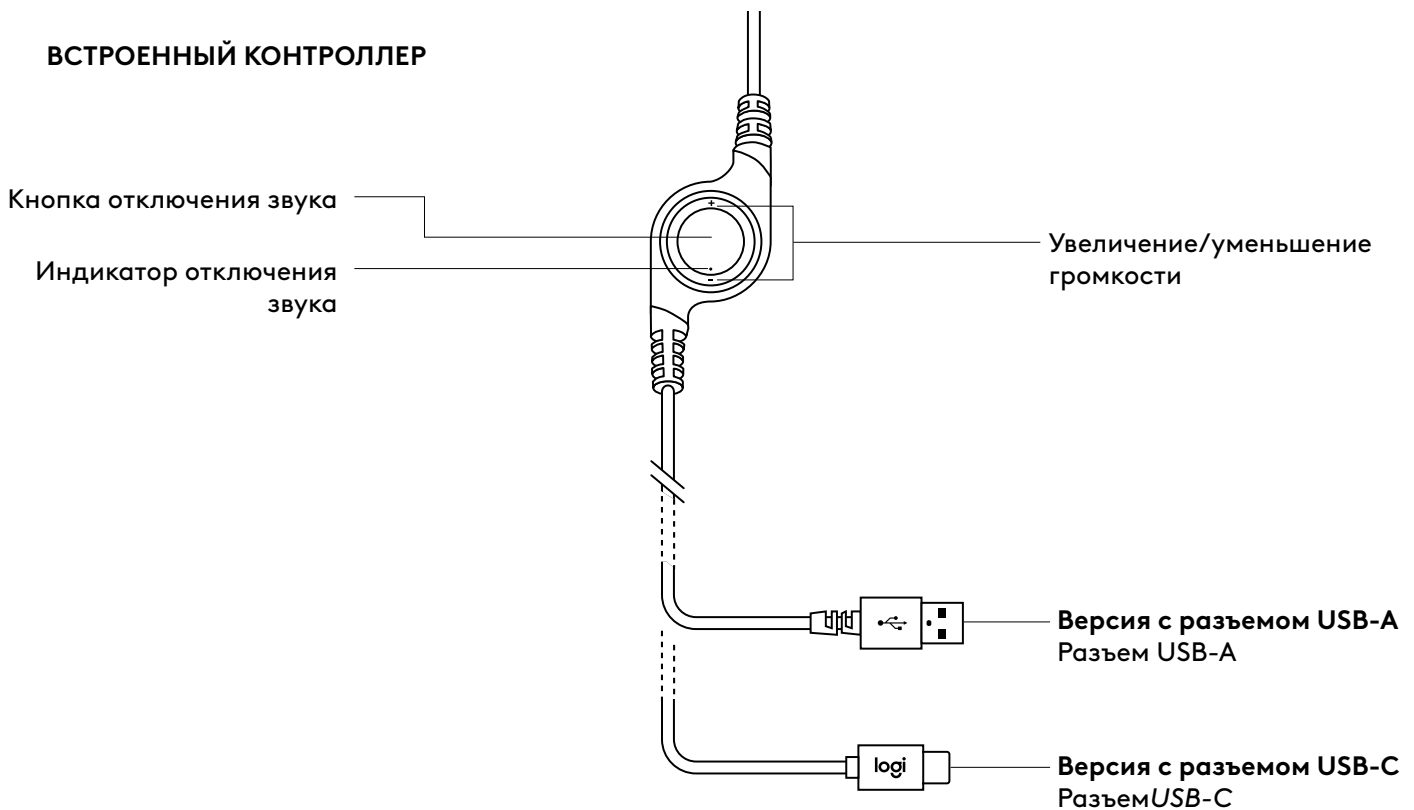

ПОДКЛЮЧЕНИЕ ГАРНИТУРЫ

Вставьте разъем USB-A в USB-порт компьютера.

ВЕРСИЯ С РАЗЪЕМОМ USB-A

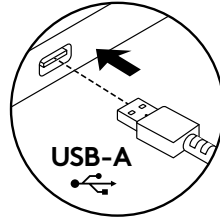

ВЕРСИЯ С РАЗЪЕМОМ USB-C

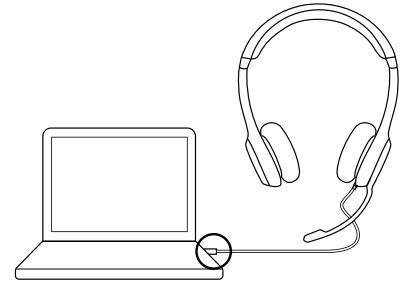
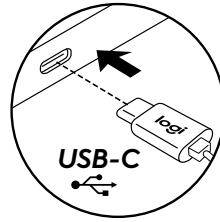

ПОСАДКА ГАРНИТУРЫ

1. Чтобы подобрать нужную высоту оголовья, двигайте его вверх-вниз, пока гарнитура не сядет как надо.
2. Перемещайте штатив микрофона вверх-вниз, пока он не займет положение, при котором ваш голос передается максимально четко.
3. Когда микрофон не используется, просто отверните держатель в сторону.

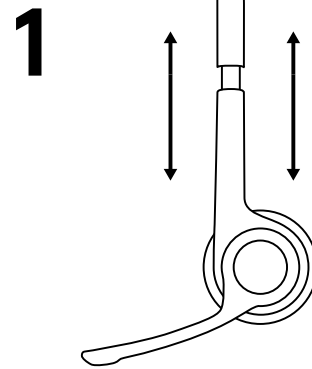

22

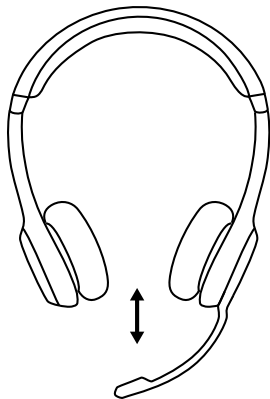

3

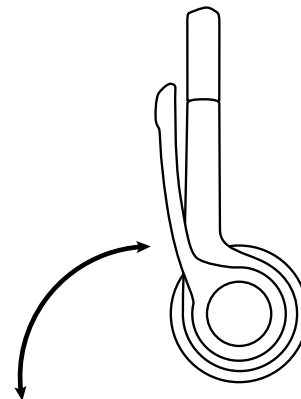

ЭЛЕМЕНТЫ УПРАВЛЕНИЯ

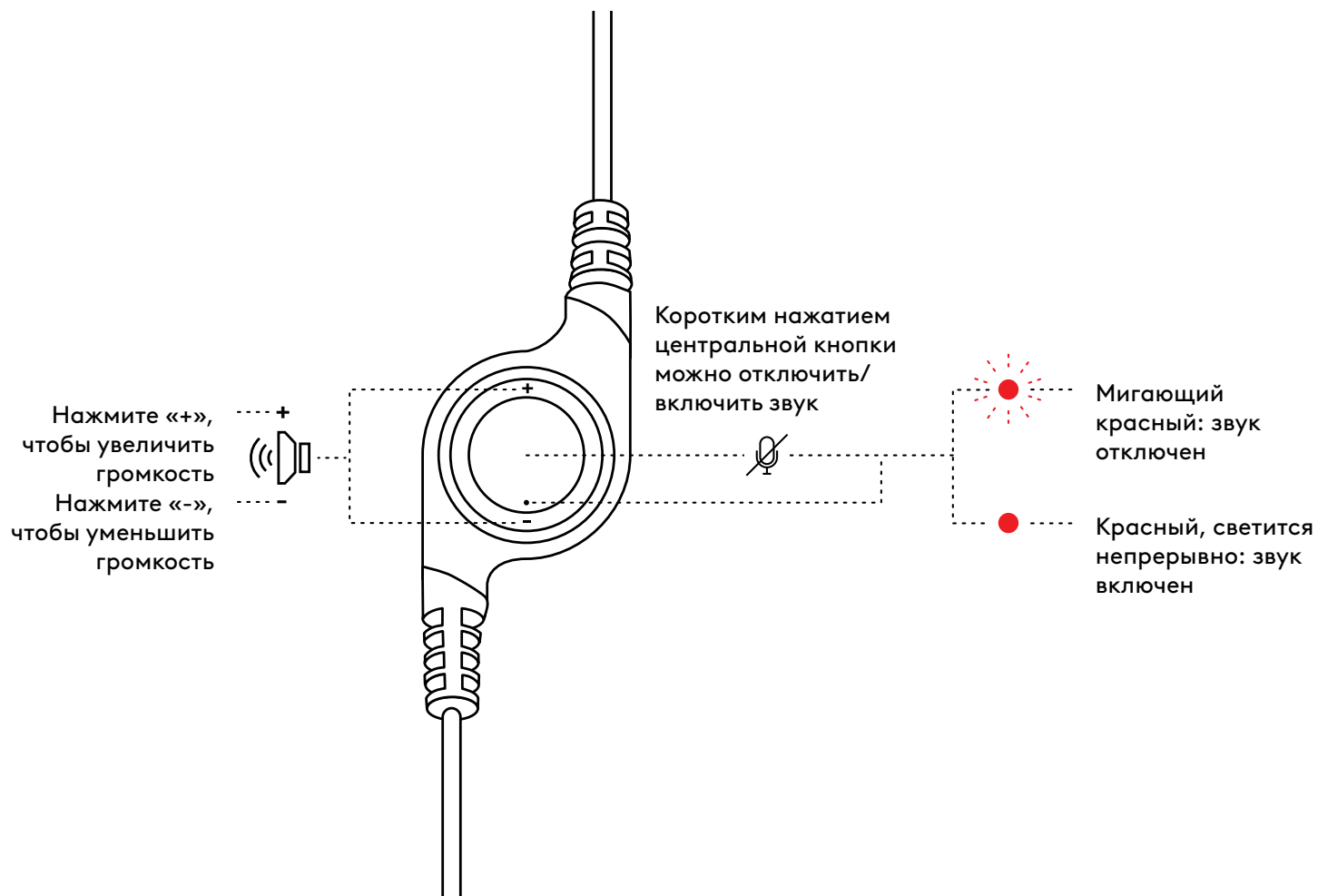

www.logitech.com/support/H390

OPIS URZĄDZENIA

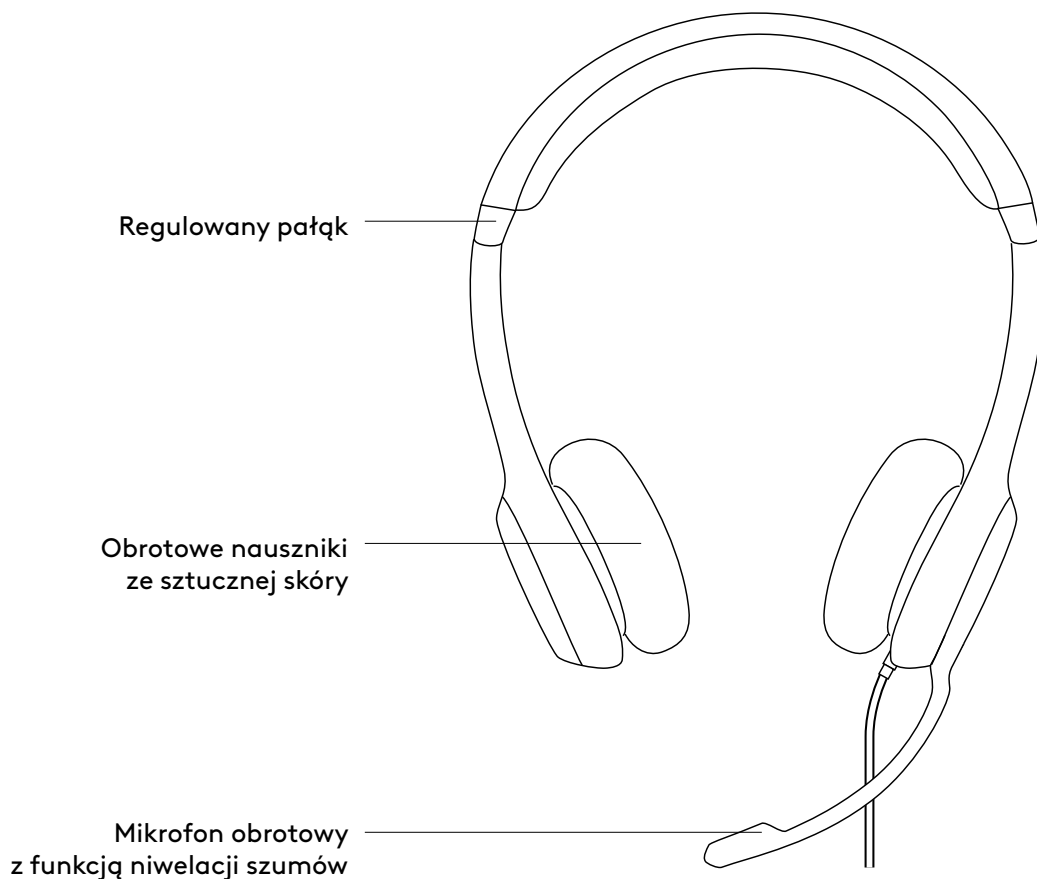

ELEMENT STERUJĄCY UMIESZCZONY NA KABLU

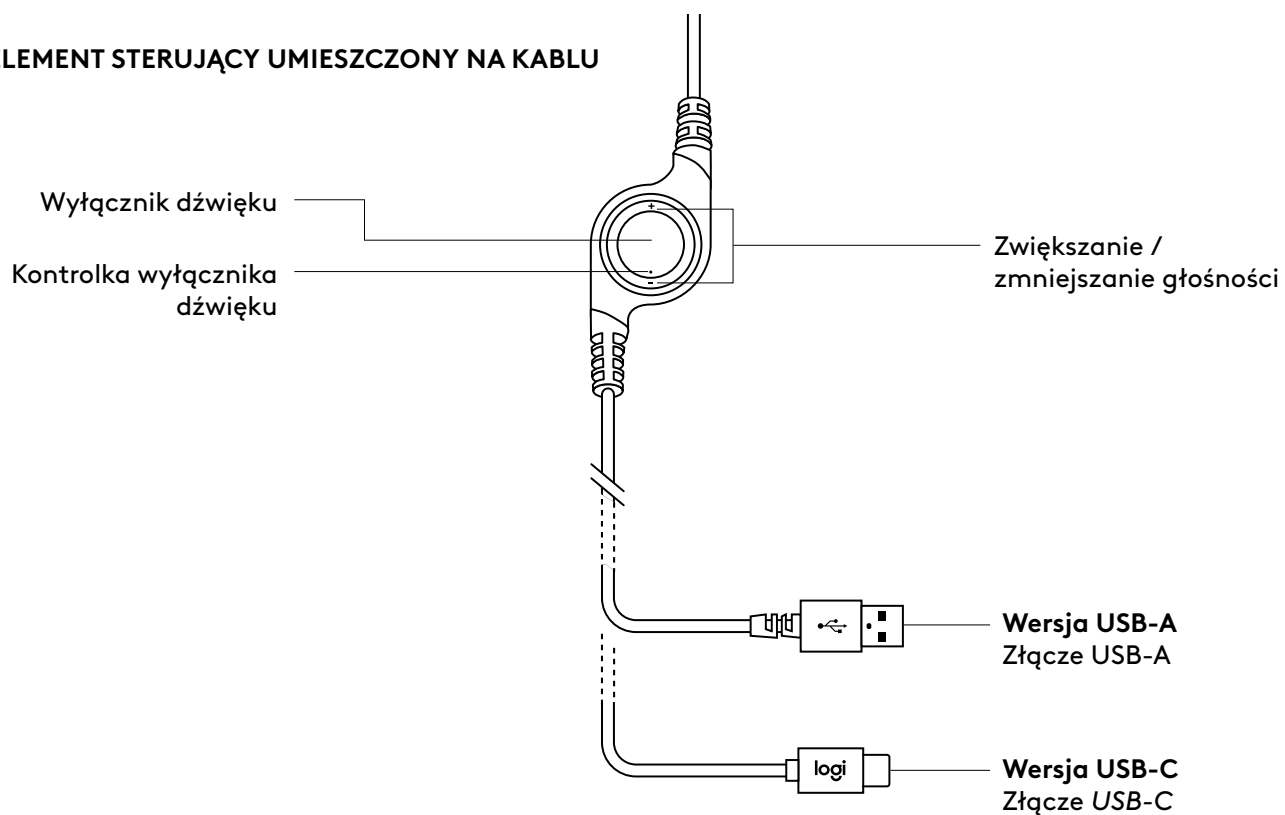

PODŁĄCZANIE ZESTAWU SŁUCHAWKOWEGO

Podłącz złącze USB do portu USB komputera.

Wersja USB-A

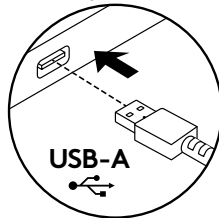

Wersja USB-C

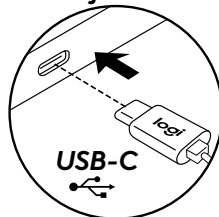

DOPASOWYWANIE ZESTAWU SŁUCHAWKOWEGO

1. Aby wyregulować rozmiar zestawu słuchawkowego, przesuwaj pałąk w górę lub w dół do momentu wygodnego dopasowania.
2. Przesuwaj wysięgnik mikrofonu w górę i w dół do momentu, aż zrówna się z ustami, aby zapewnić lepsze przechwytywanie dźwięku.
3. Gdy wysięgnik mikrofonu nie jest używany, wystarczy go odsunąć.

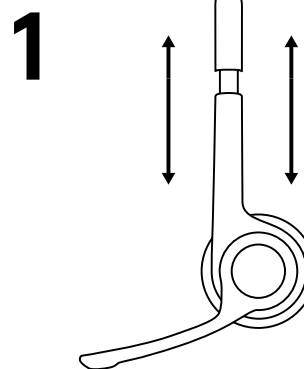

2

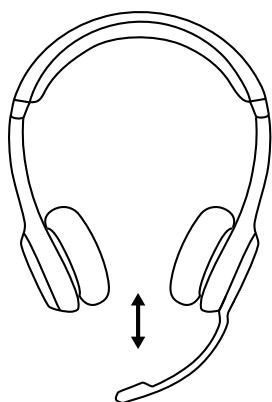

3

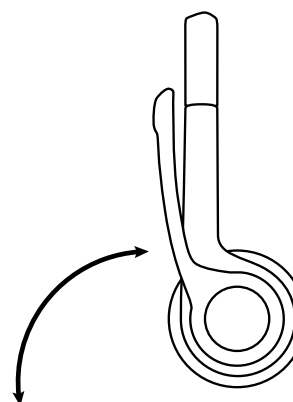

STEROWANIE

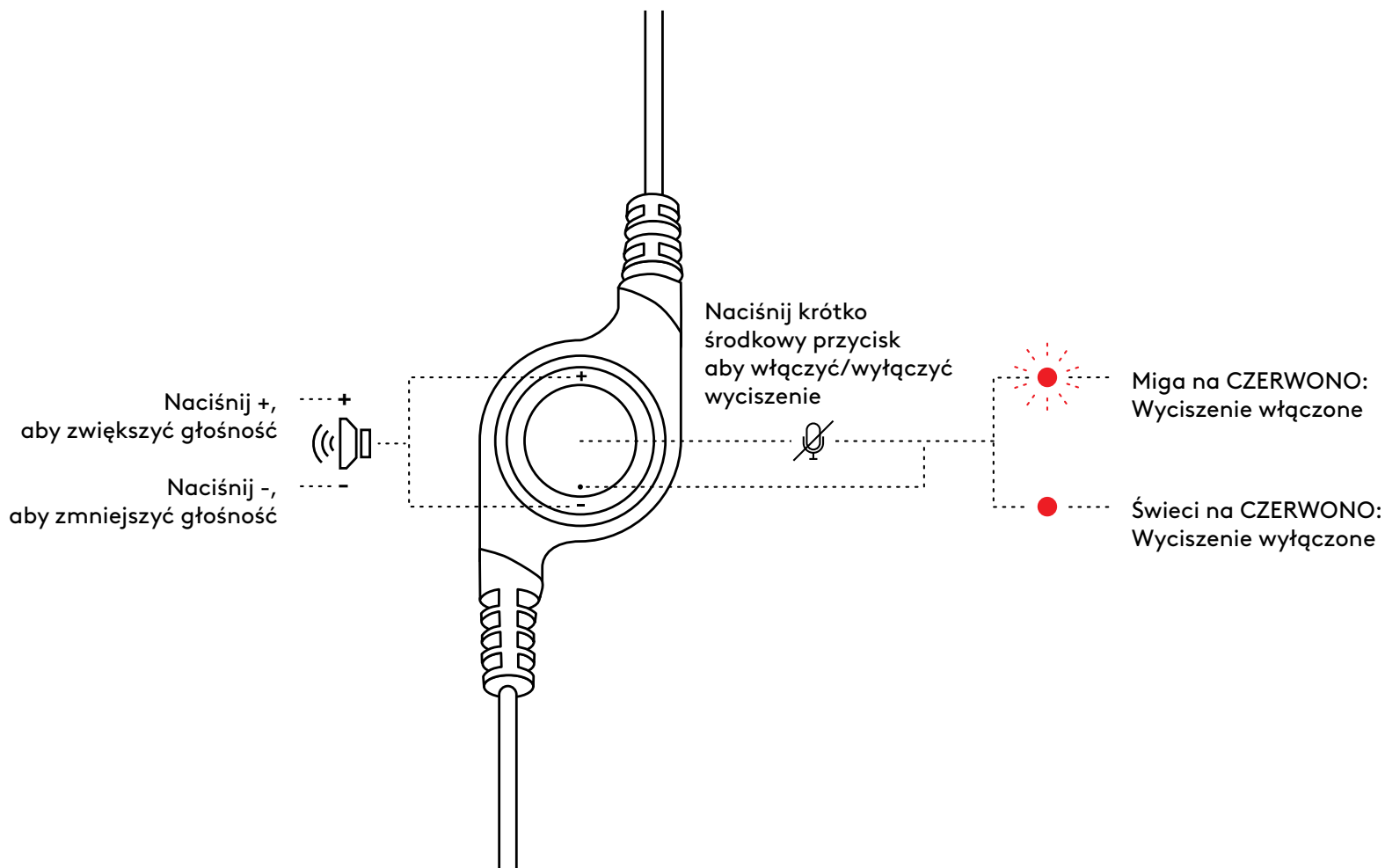

www.logitech.com/support/H390

A TERMÉK ISMERTETÉSE

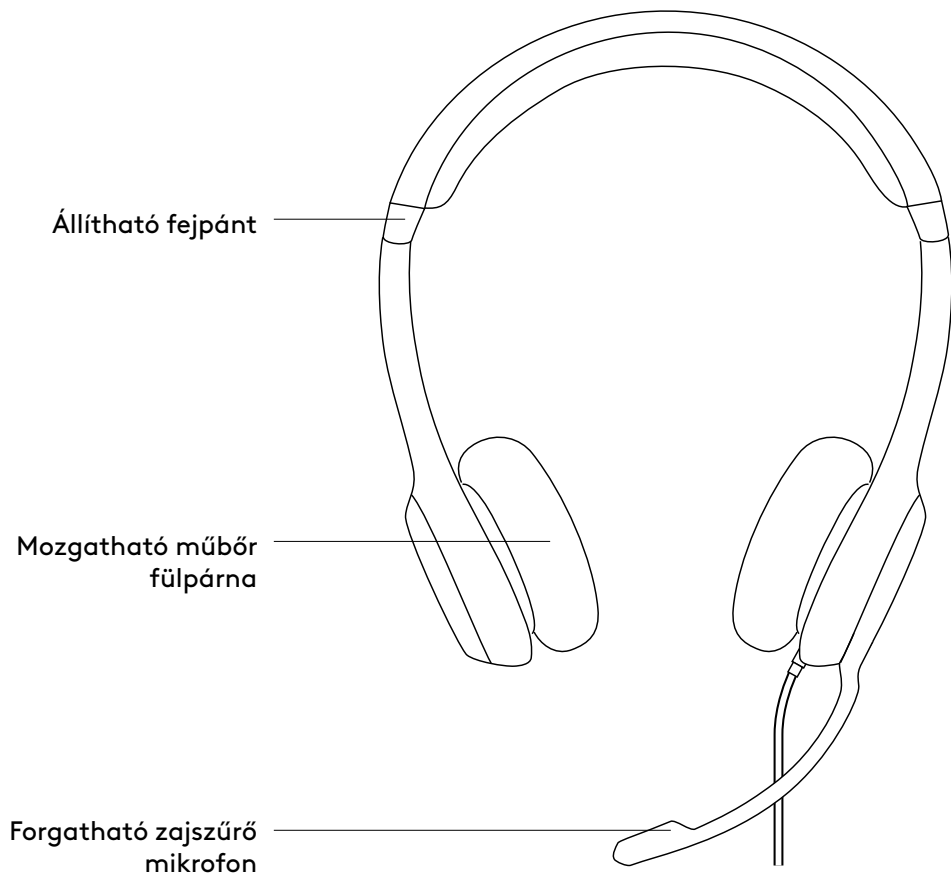

VEZETÉKBE ÉPÍTETT VEZÉRLŐ

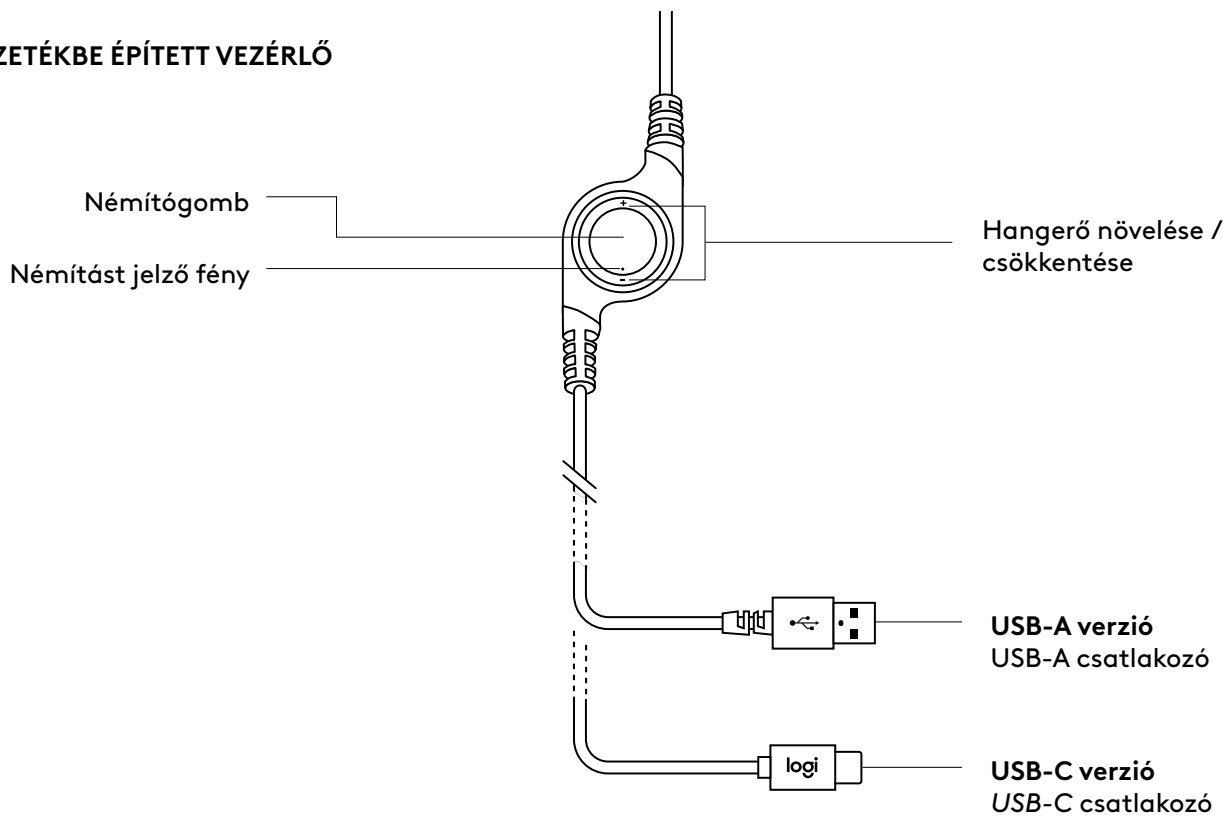

A MIKROFONOS FEJHALLGATÓ CSATLAKOZTATÁSA

Csatlakoztassa az USB-csatlakozót a számítógép USB-portjába.

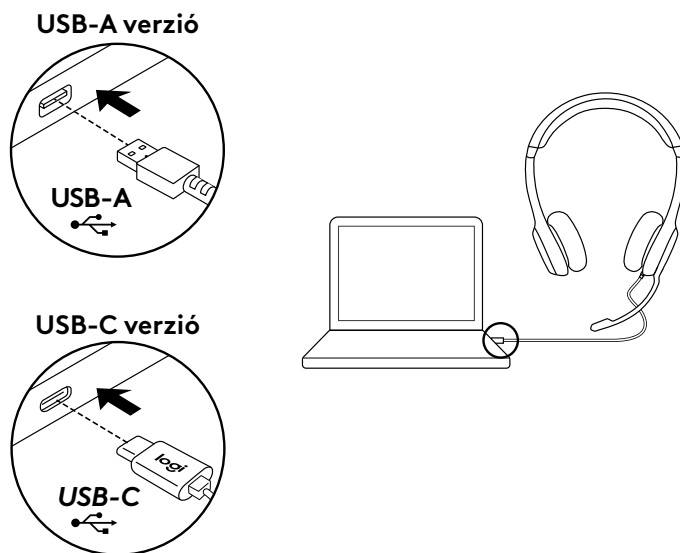

A MIKROFONOS FEJHALLGATÓ MÉRETRE ÁLLÍTÁSA

1. A mikrofonos fejhallgató méretének beállításához mozgassa fel-le a fejpántot, amíg az kényelmes nem lesz.
2. A jobb hangérzékeléshez mozgassa fel-le a mikrofonkart, amíg a szájá elé nem kerül.
3. A mikrofonkar felhajtható, amikor éppen nem használja.

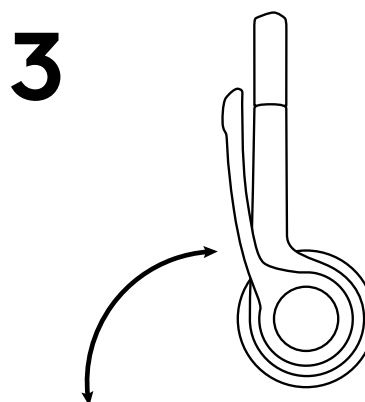
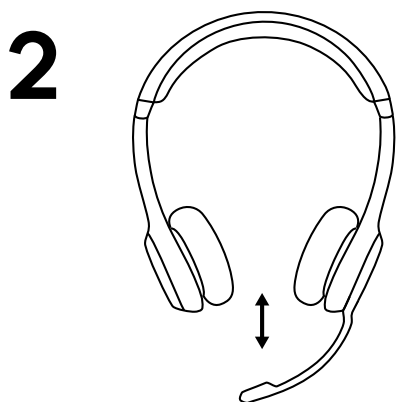
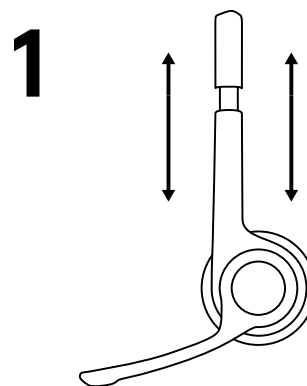

KEZELŐSZERVEK

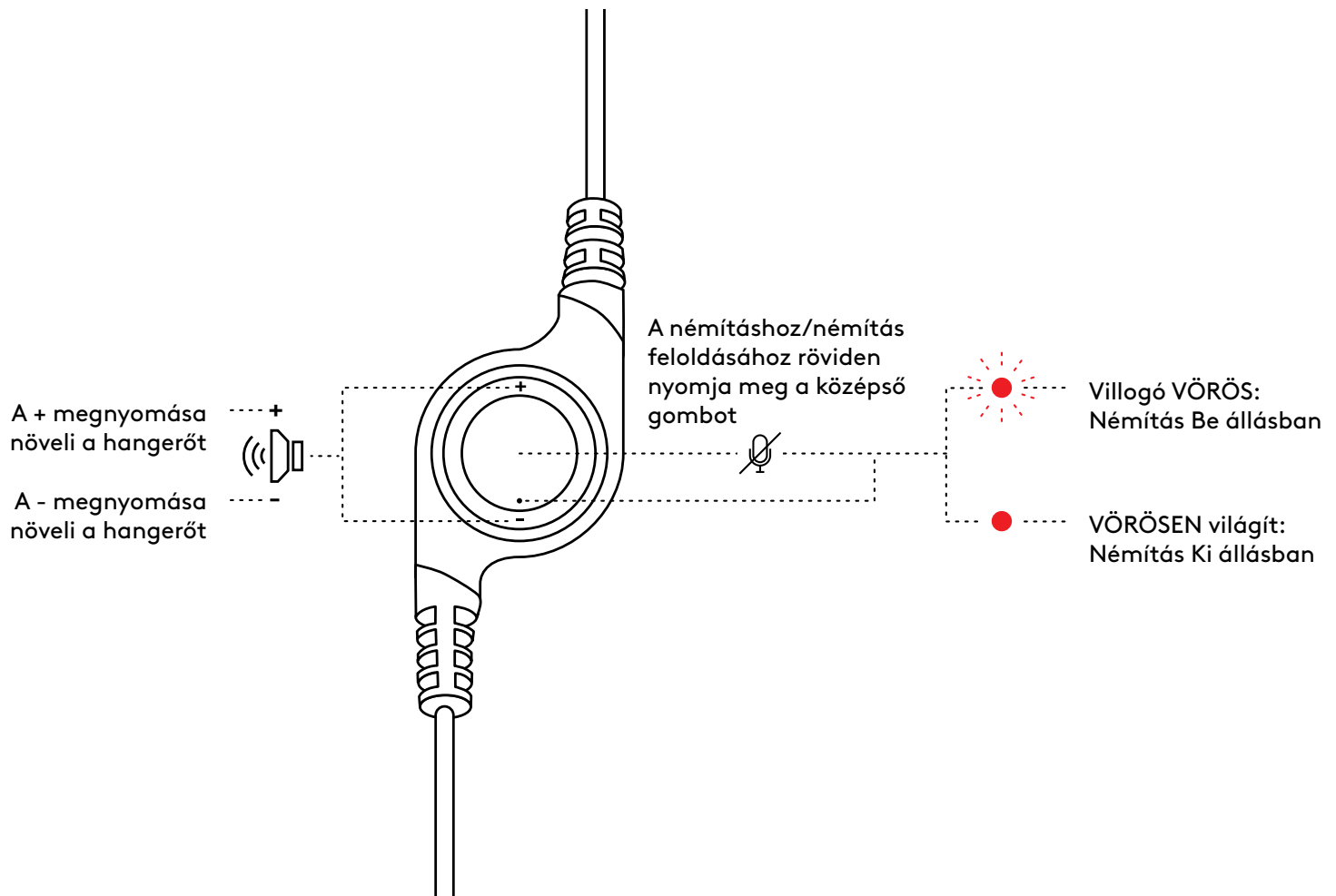

www.logitech.com/support/H390

POPIS PRODUKTU

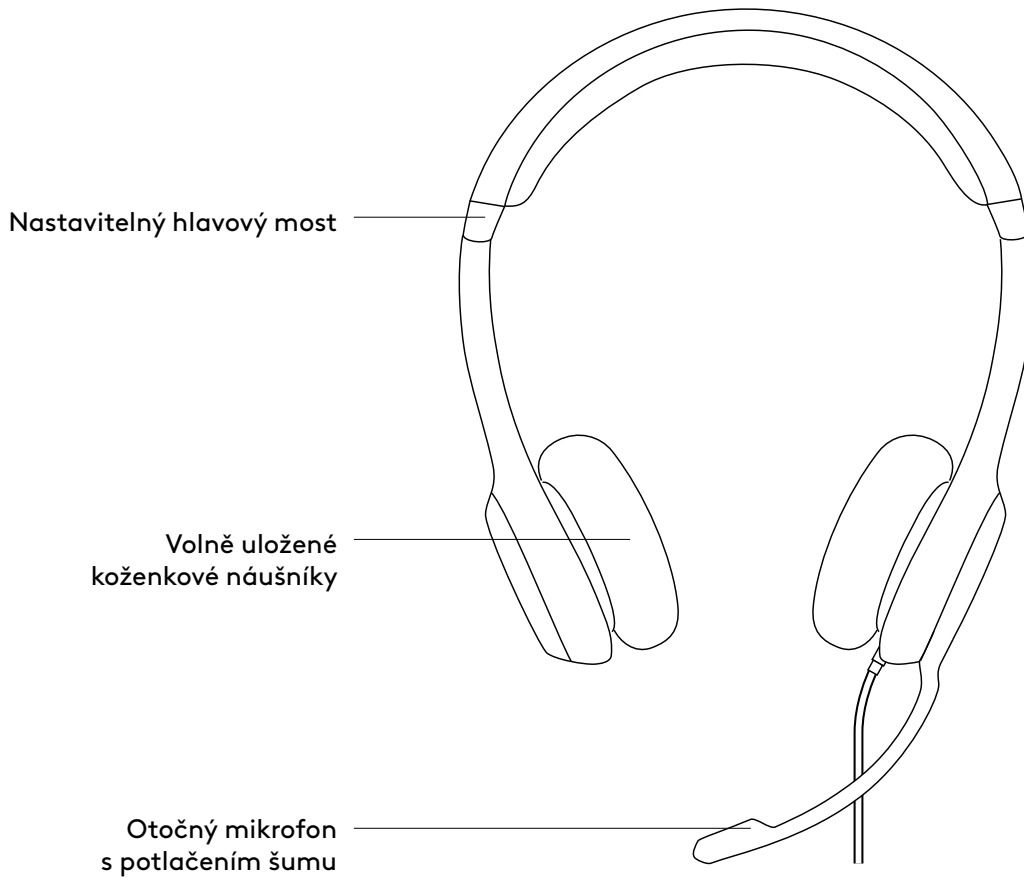

INTEGROVANÝ OVLADAČ

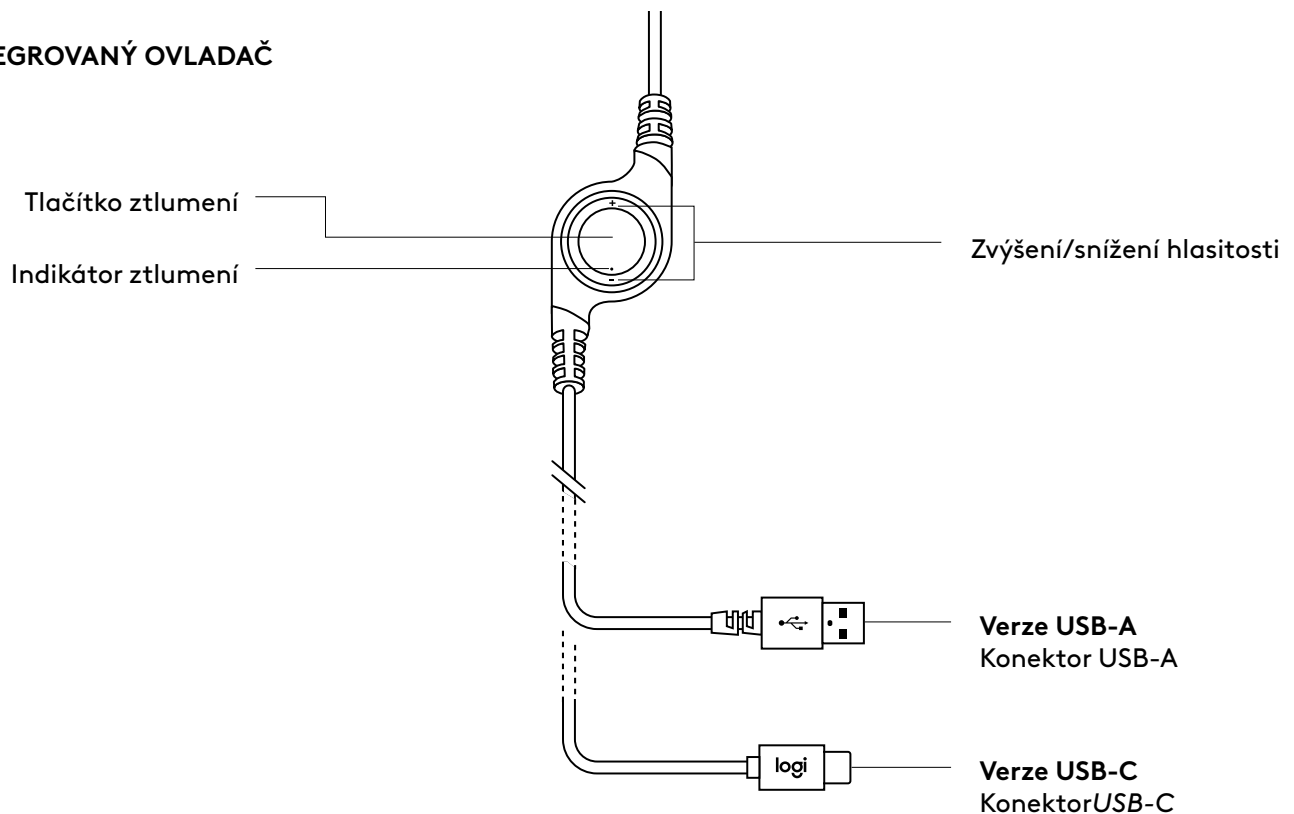

PŘIPOJENÍ NÁHLAVNÍ SOUPRAVY

Připojte konektor USB k portu USB v počítači.

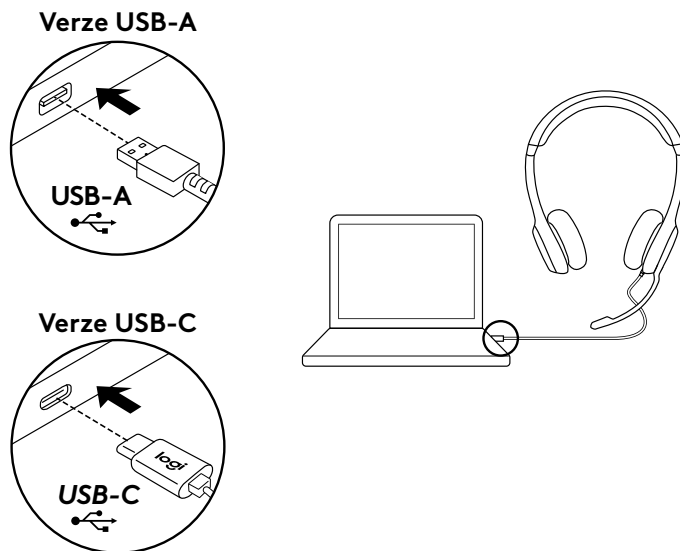

USAZENÍ NÁHLAVNÍ SOUPRAVY

1. Nastavte si velikost náhlavní soupravy posouváním hlavového mostu nahoru a dolů, dokud vám pohodlně nepadne.
2. Nastavte si držák s mikrofonem pohyby nahoru nebo dolů tak, aby byl v rovině s vašimi ústy pro lepší snímání hlasu.
3. Když držák mikrofonu nepoužíváte, stačí jej odklopit stranou.

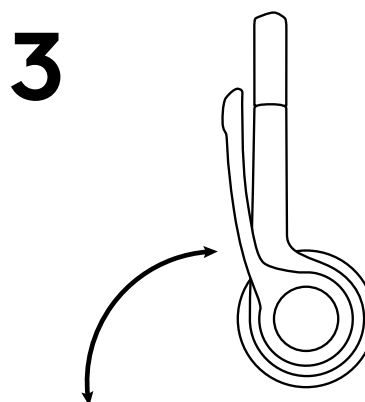
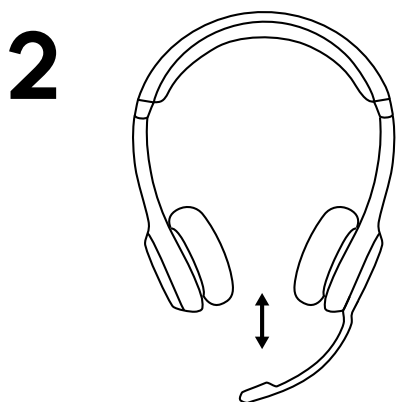
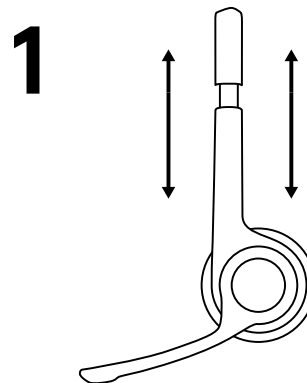

OVLÁDACÍ PRVKY

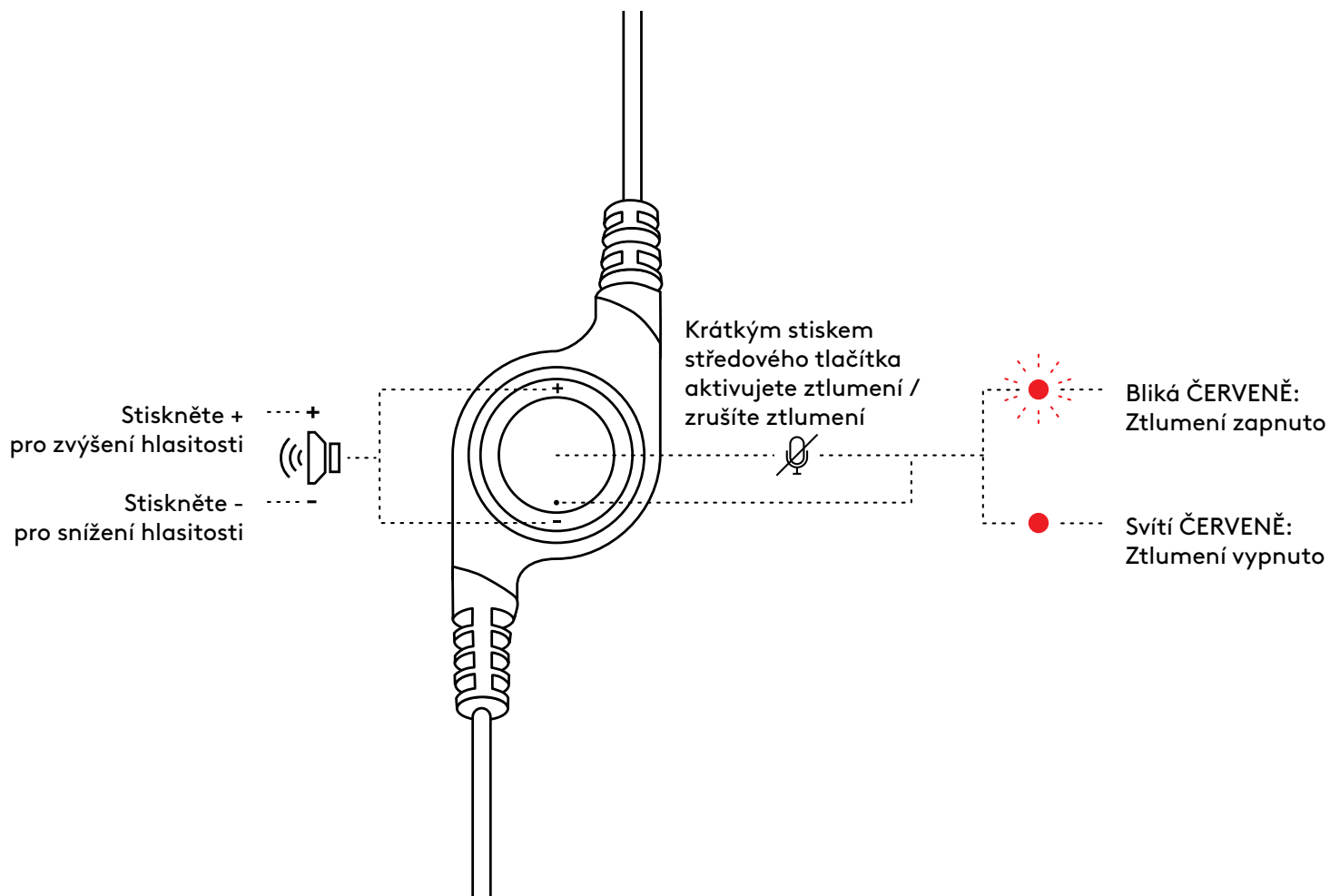

www.logitech.com/support/H390

POPIS PRODUKTU

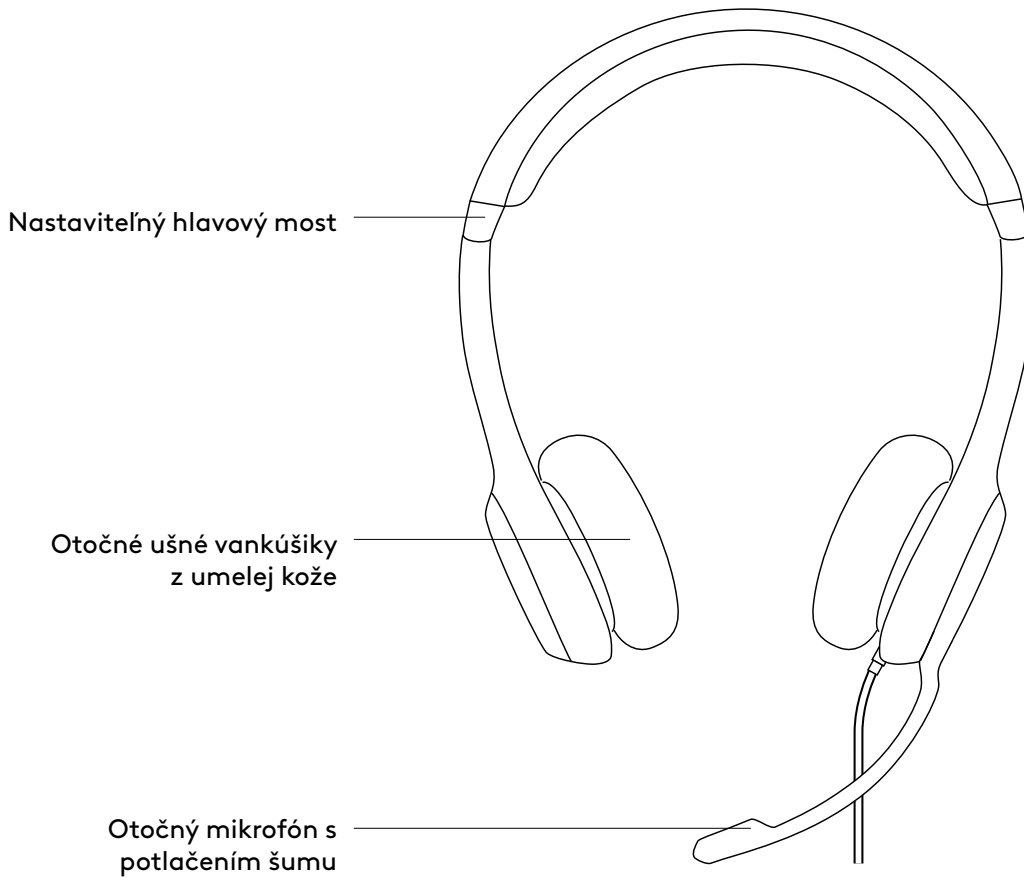

INTEGROVANÝ OVLÁDAČ

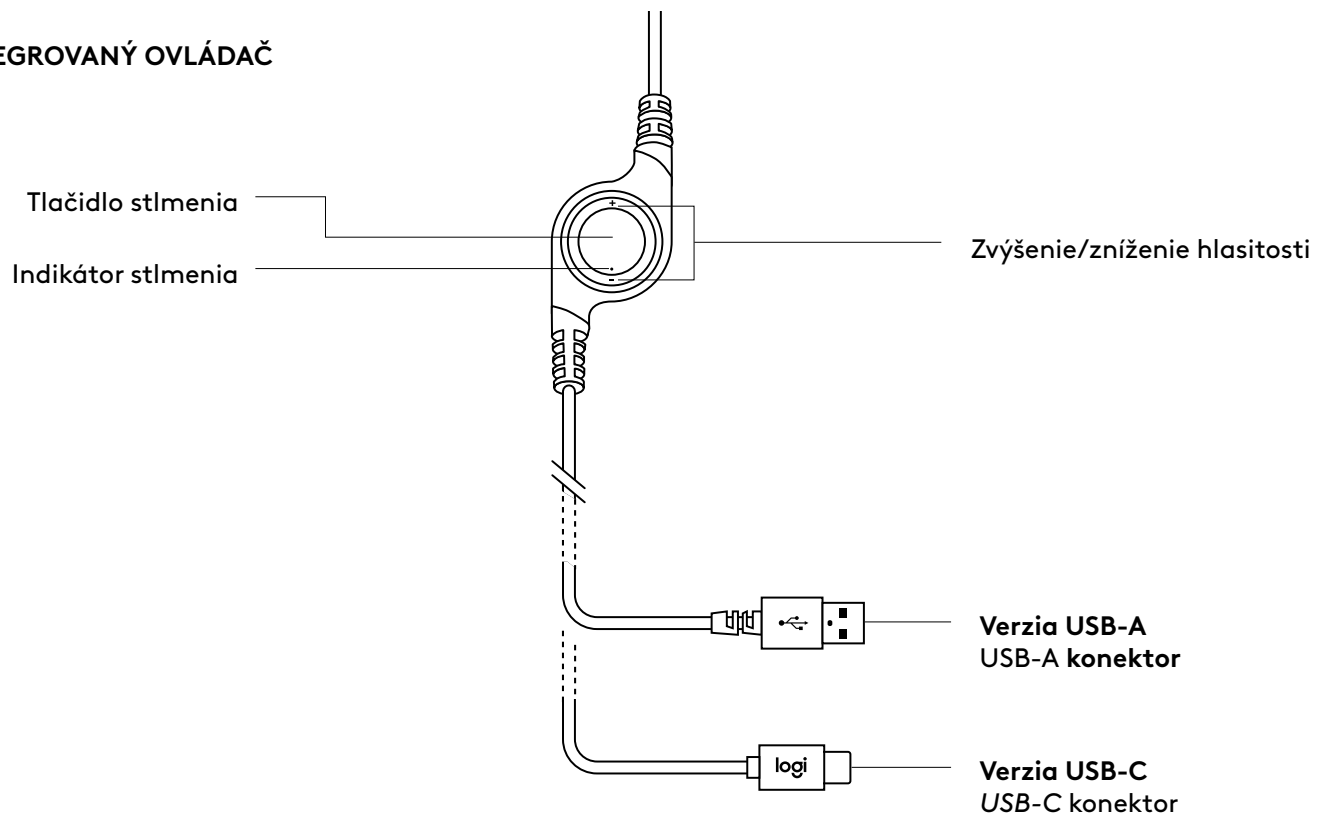

PRIPOJENIE NÁHLAVNEJ SÚPRAVY

Pripojte konektor USB k portu USB v počítači.

Verzia USB-A

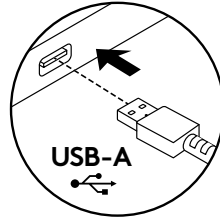

Verzia USB-C

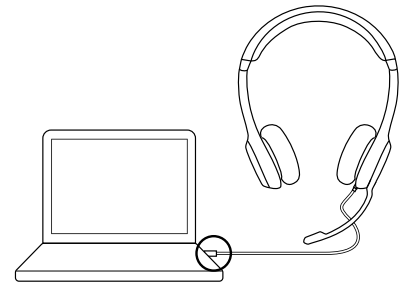
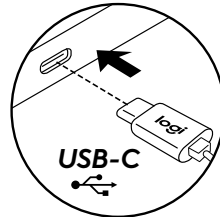

USADENIE NÁHLAVNEJ SÚPRAVY

1. Nastavte si veľkosť náhlavnej súpravy posúvaním hlavového mosta nahor a nadol, kým vám nebude pohodlne sedieť.
2. Nastavte si držiak s mikrofónom pohybmi nahor alebo nadol tak, aby bol v rovine s vašimi ústami a mohol tak lepšie snímať hlas.
3. Keď držiak mikrofónu nepoužívate, stačí ho odklopiť nabok.

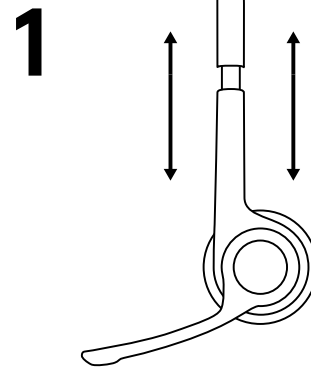

2

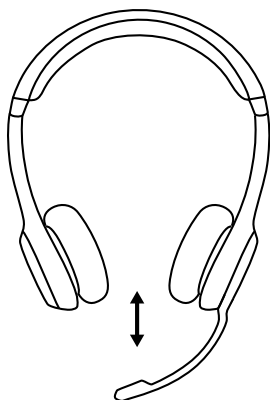

3

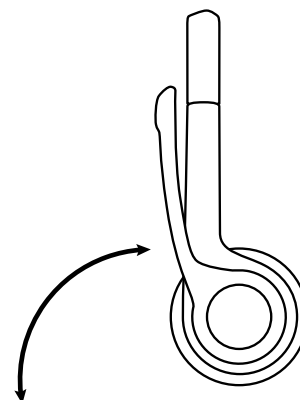

OVLÁDACIE PRVKY

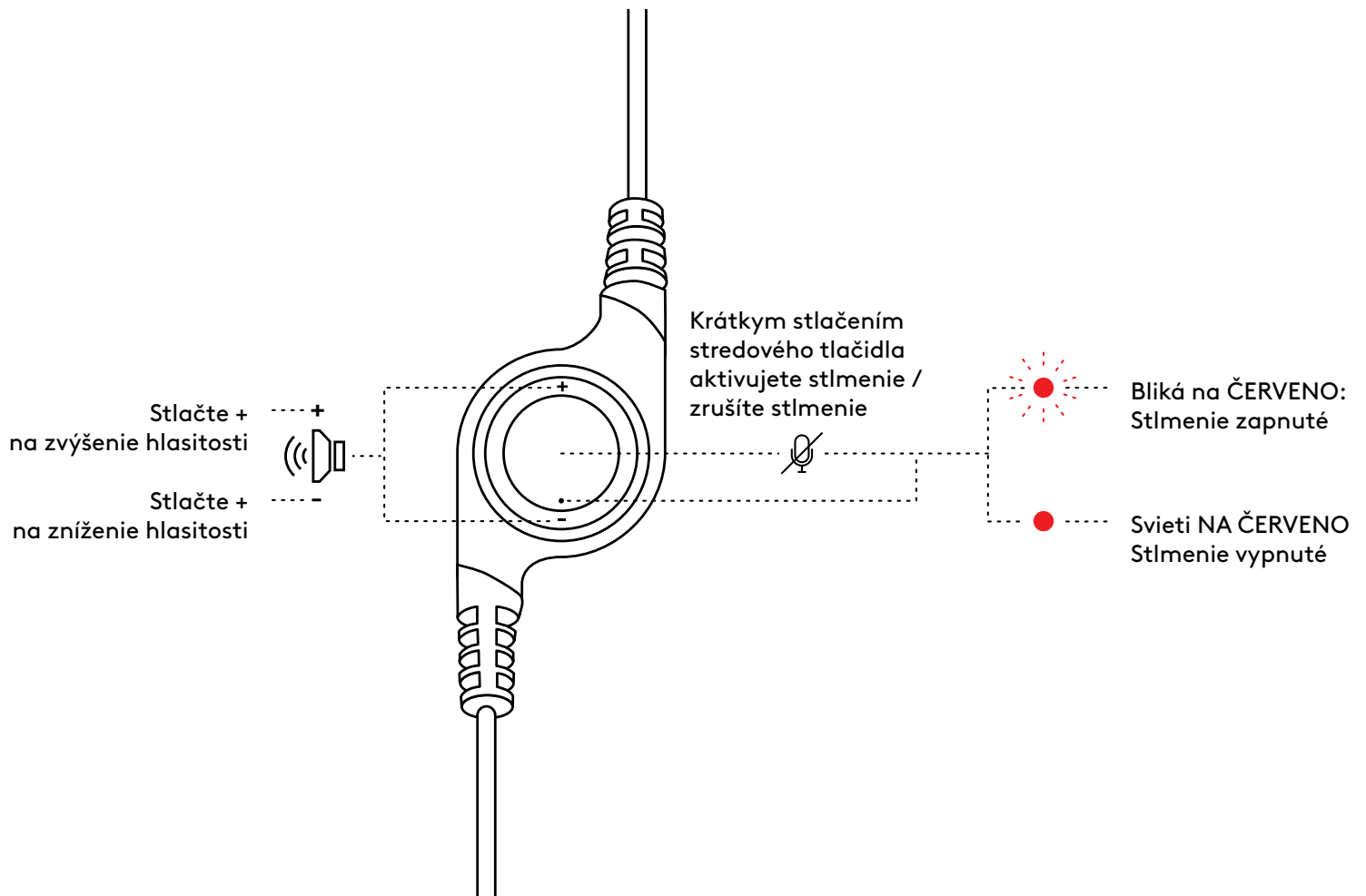

www.logitech.com/support/H390

ОЗНАЙОМЛЕННЯ З ПРОДУКТОМ



ВБУДОВАНИЙ КОНТРОЛЕР

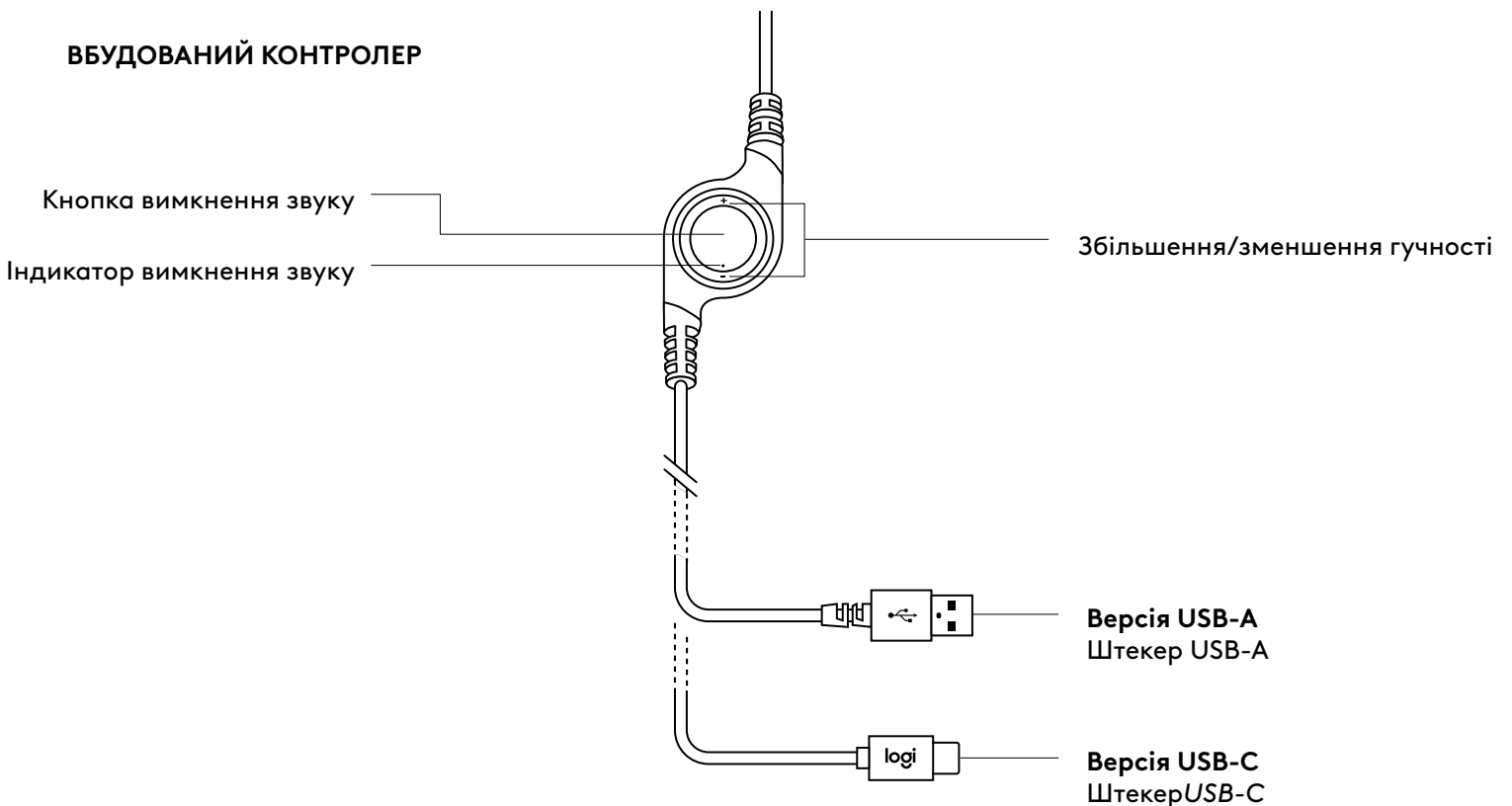

ПІДКЛЮЧЕННЯ ГАРНІТУРИ

Вставте штекер USB у USB-порт комп'ютера.

Версія USB-A

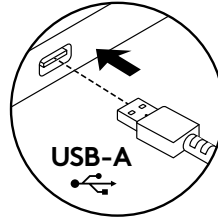

Версія USB-C

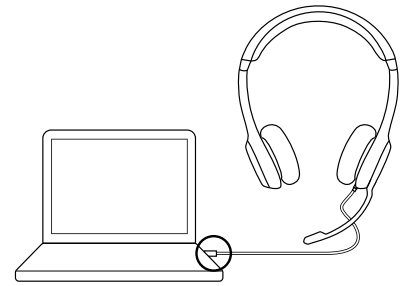
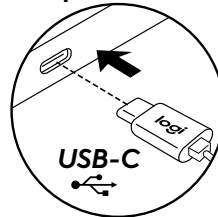

ПОСАДКА ГАРНІТУРИ

1. Щоб відрегулювати висоту наголів'я, рухайте його вгору-вниз, поки гарнітура не сяде як треба.
2. Переміщуйте штатив мікрофона вгору-вниз, поки він не набуде положення, в якому ваш голос передаватиметься максимально чітко.
3. Коли мікрофон не використовується, його можна повернути вбік.

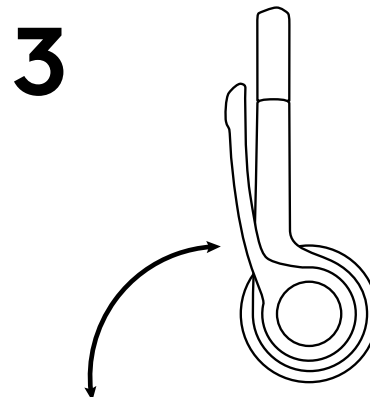
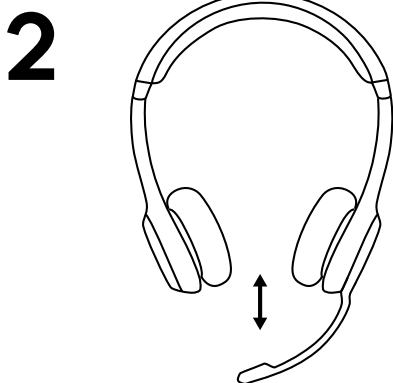
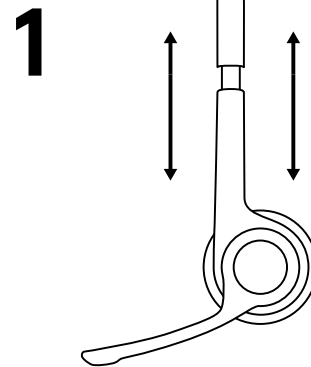

ЕЛЕМЕНТИ КЕРУВАННЯ

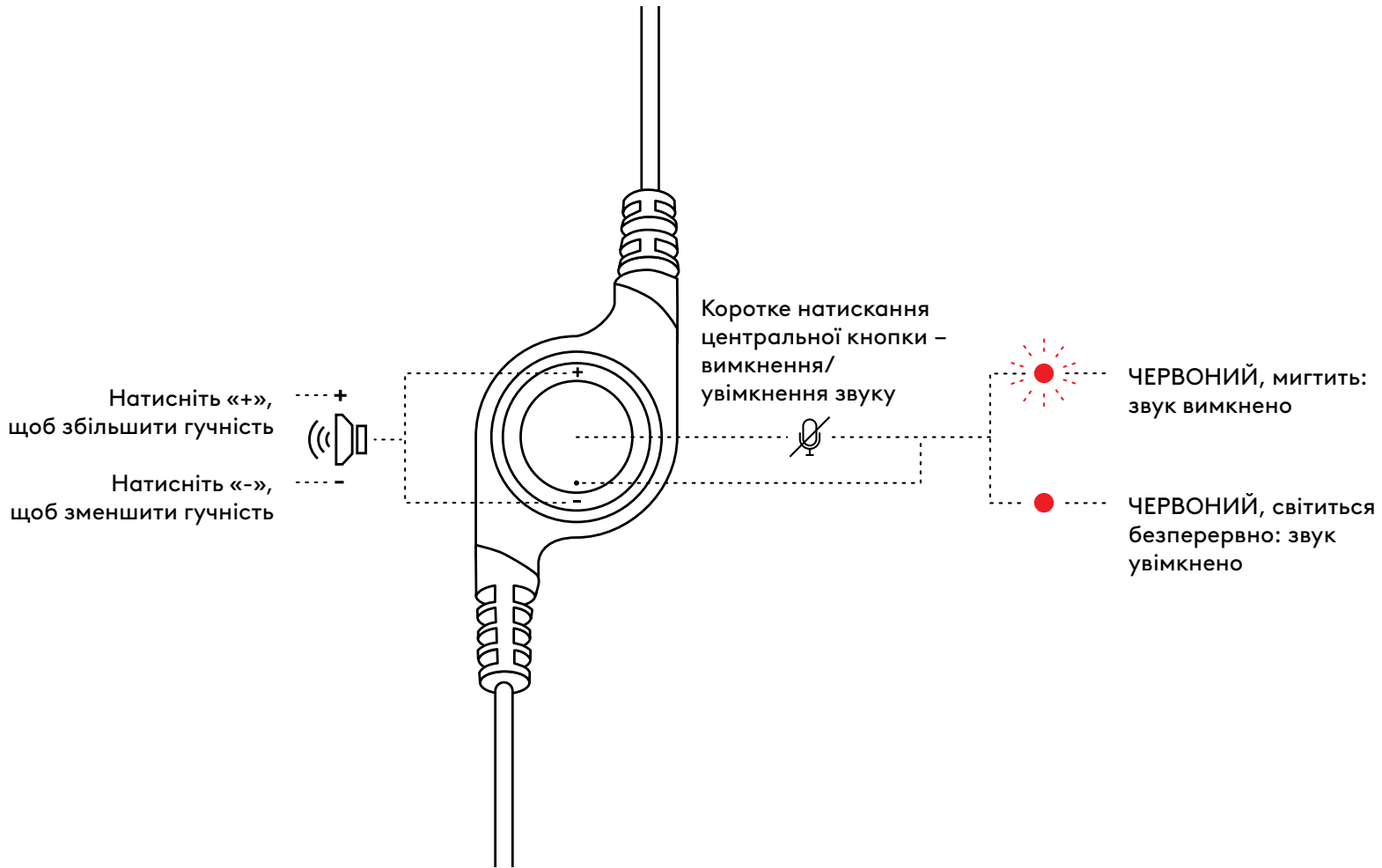

www.logitech.com/support/H390

TOOTE TUTVUSTUS

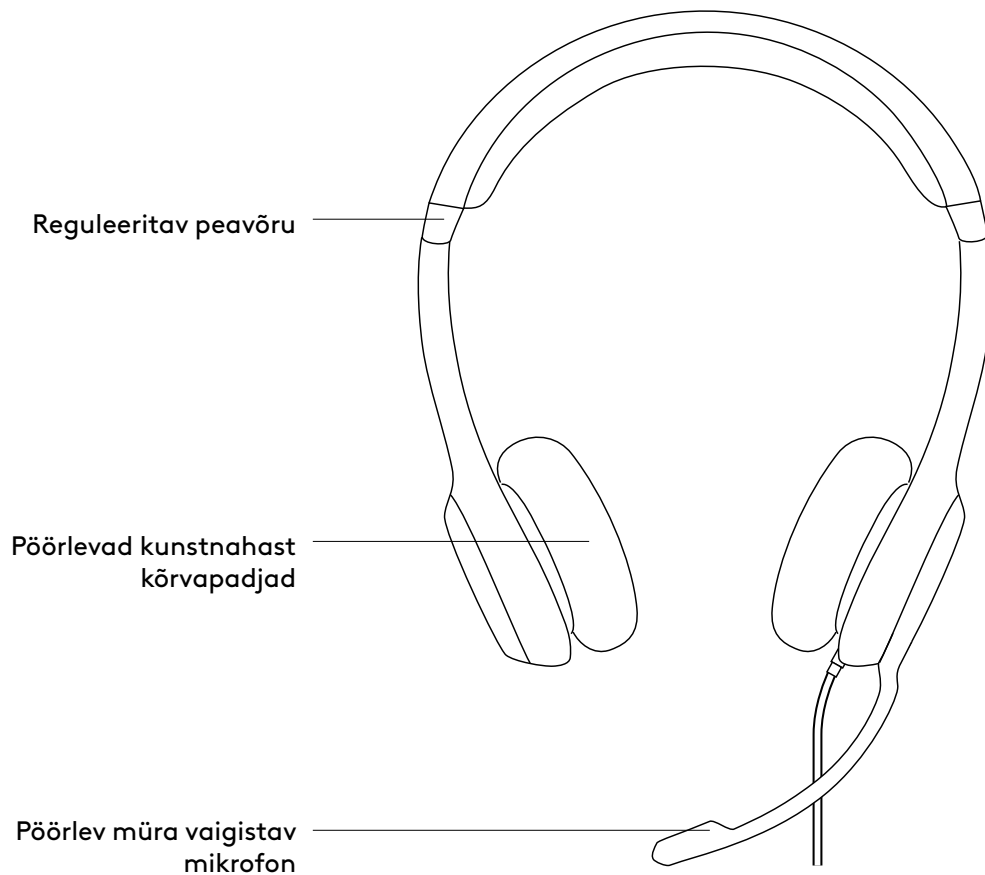

JUHTMEL ASUV KONTROLLER

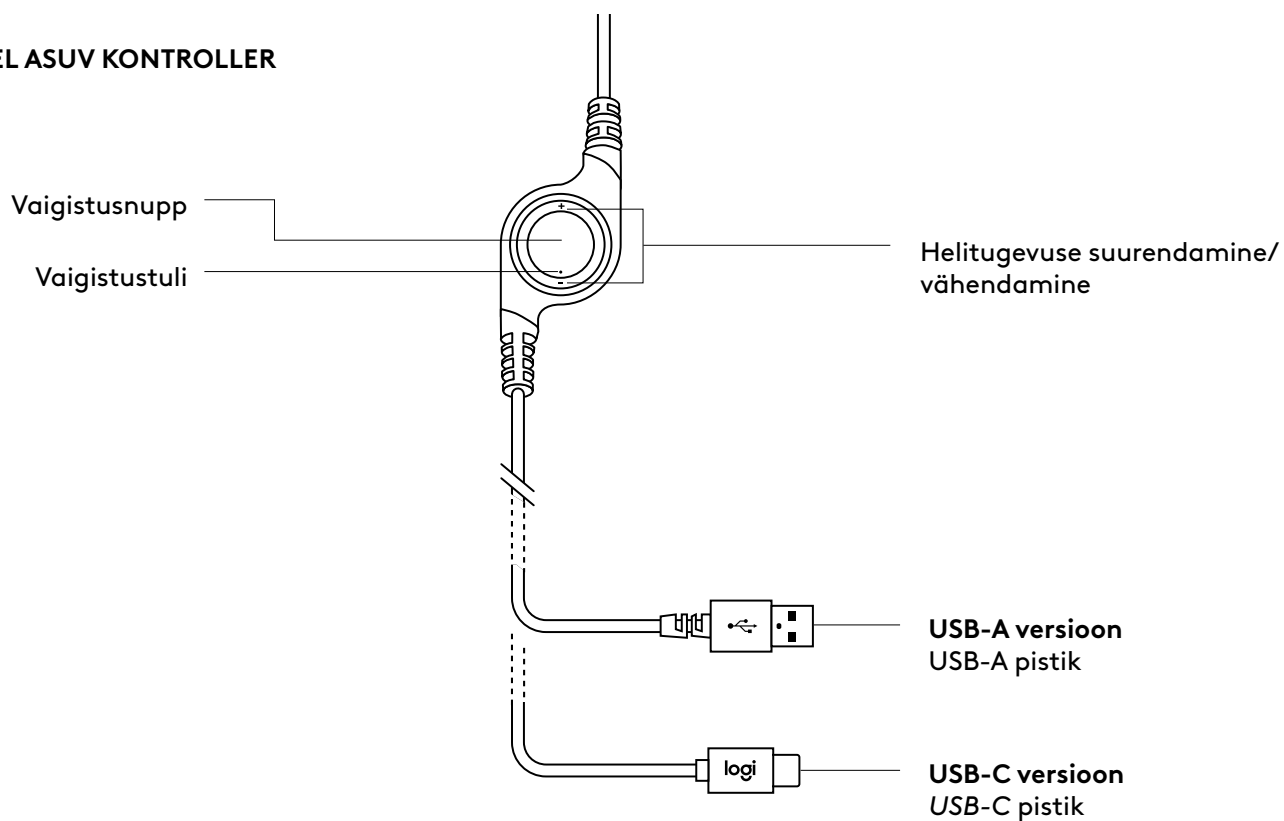

PEAKOMPLEKTI ÜHENDAMINE

Ühendage USB pistik arvuti USB-porti.

USB-A versioon

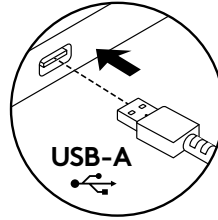

USB-C versioon

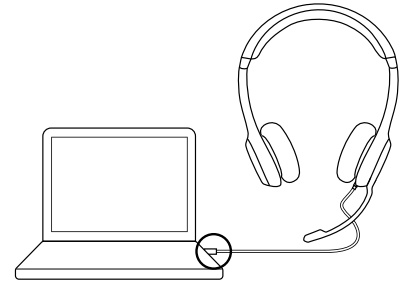
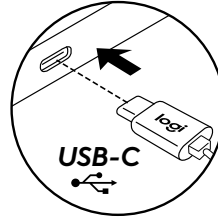

PEAKOMPLEKTI PÄHESOBIVUS

1. Peakomplekti suuruse reguleerimiseks liigutage seda üles ja alla, kuni leiate mugavaima asendi.
2. Parima häälesalvestuse saavutamiseks liigutage mikrofonivart üles või alla, kuni see on suuga sama kõrgel.
3. Kui te mikrofoni ei kasuta, saate selle eest ära keerata.

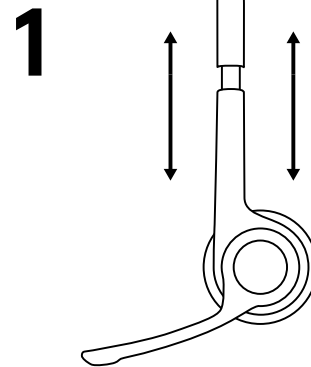

2

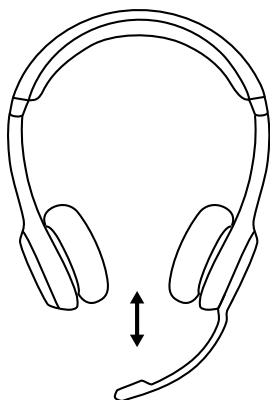

3

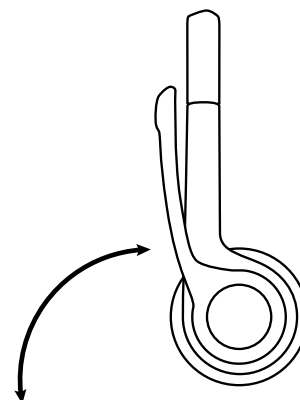

JUHTELEMENDID

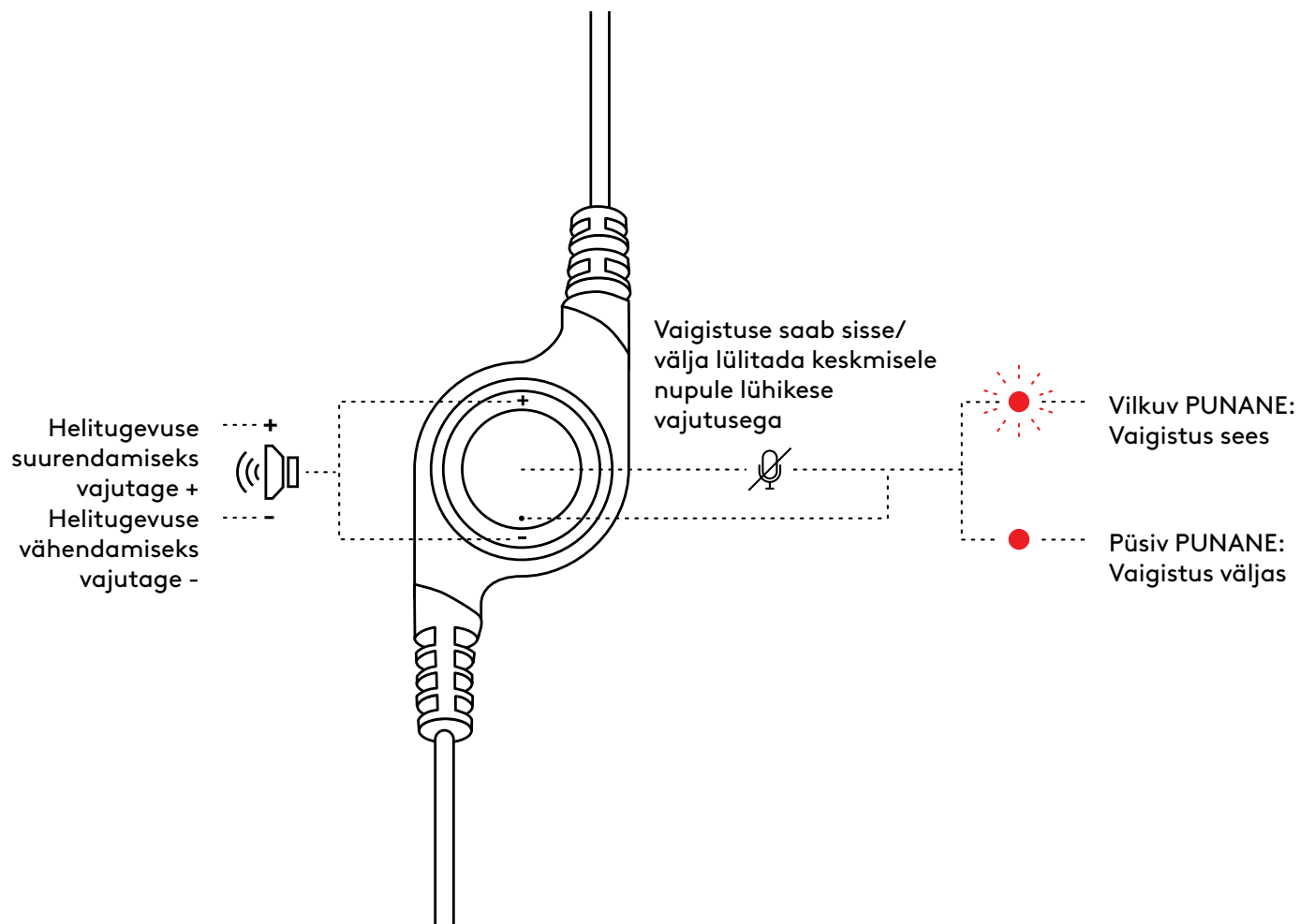

www.logitech.com/support/H390

PĀRZINIET SAVU IERĪCI

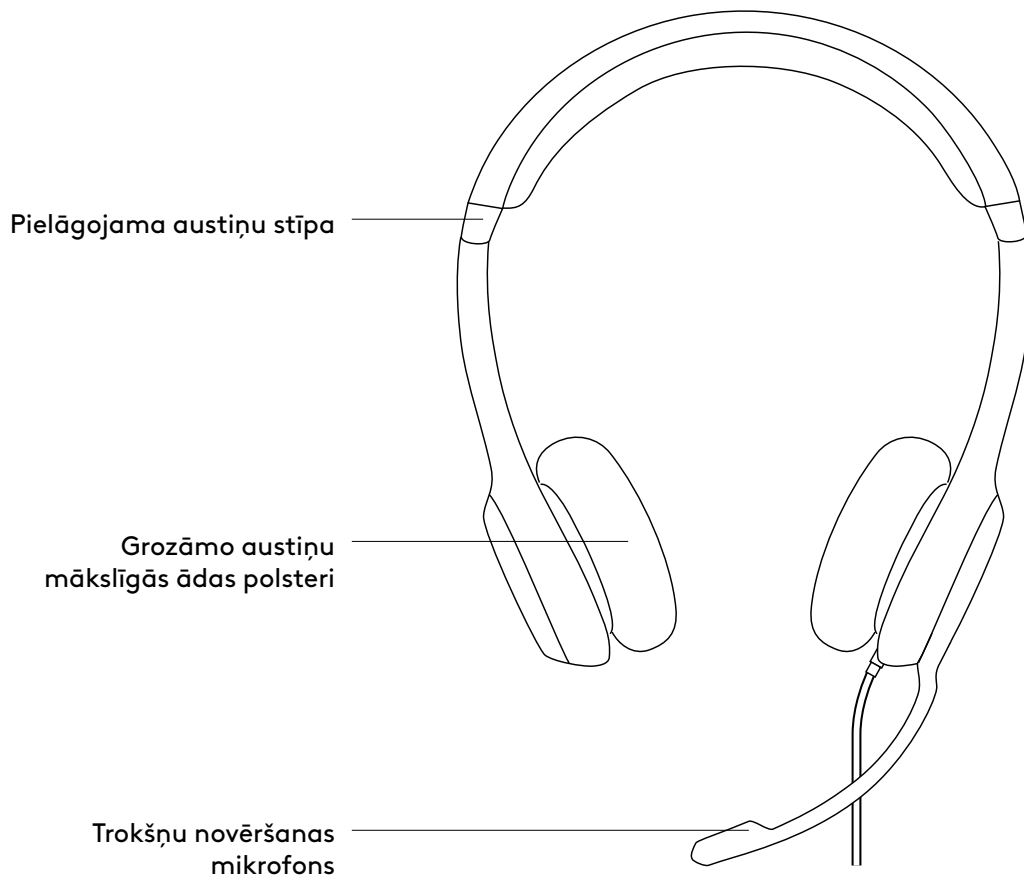

IEBŪVĒTAS VADĪKLAS

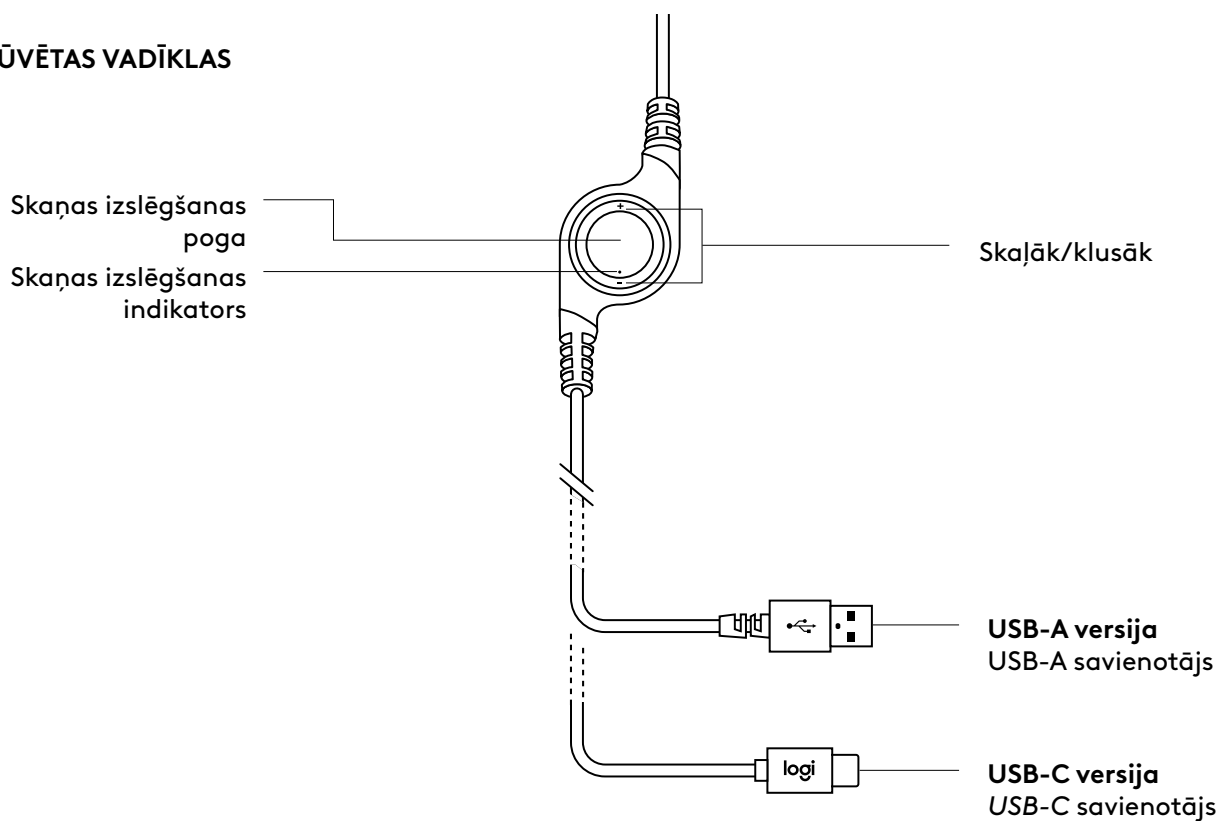

AUSTIŅU PIEVIENOŠANA

Iespraudiet USB savienotāju datora USB pieslēgvietā.

USB-A versija

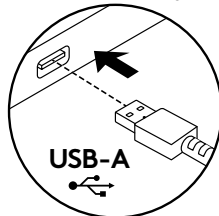

USB-C versija

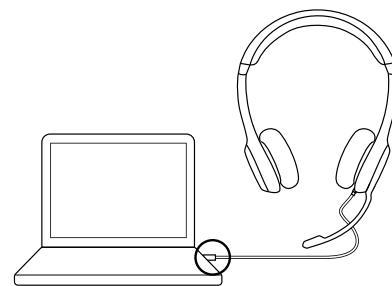
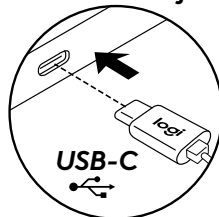

AUSTIŅU REGULĒŠANA

1. Lai noregulētu ausiņu izmēru, pārvietojiet ausiņu stīpu uz augšu vai leju, līdz tā ērti der uz galvas.
2. Pārvietojiet mikroфона kātiņu uz augšu vai uz leju, līdz tas ir vienā līmenī ar jūsu muti, šādi nodrošinot labāku skaņas uztveršanu.
3. Kad neizmantojat mikrofonu, tā kātiņu var pacelt uz augšu, lai tas netraucētu.

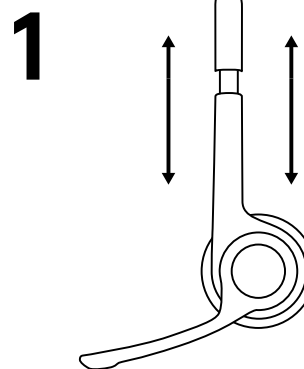

2

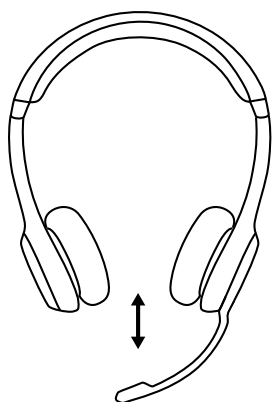

3

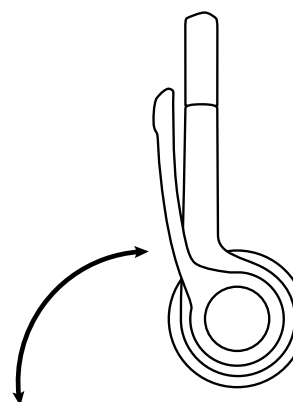

VADĪKLAS

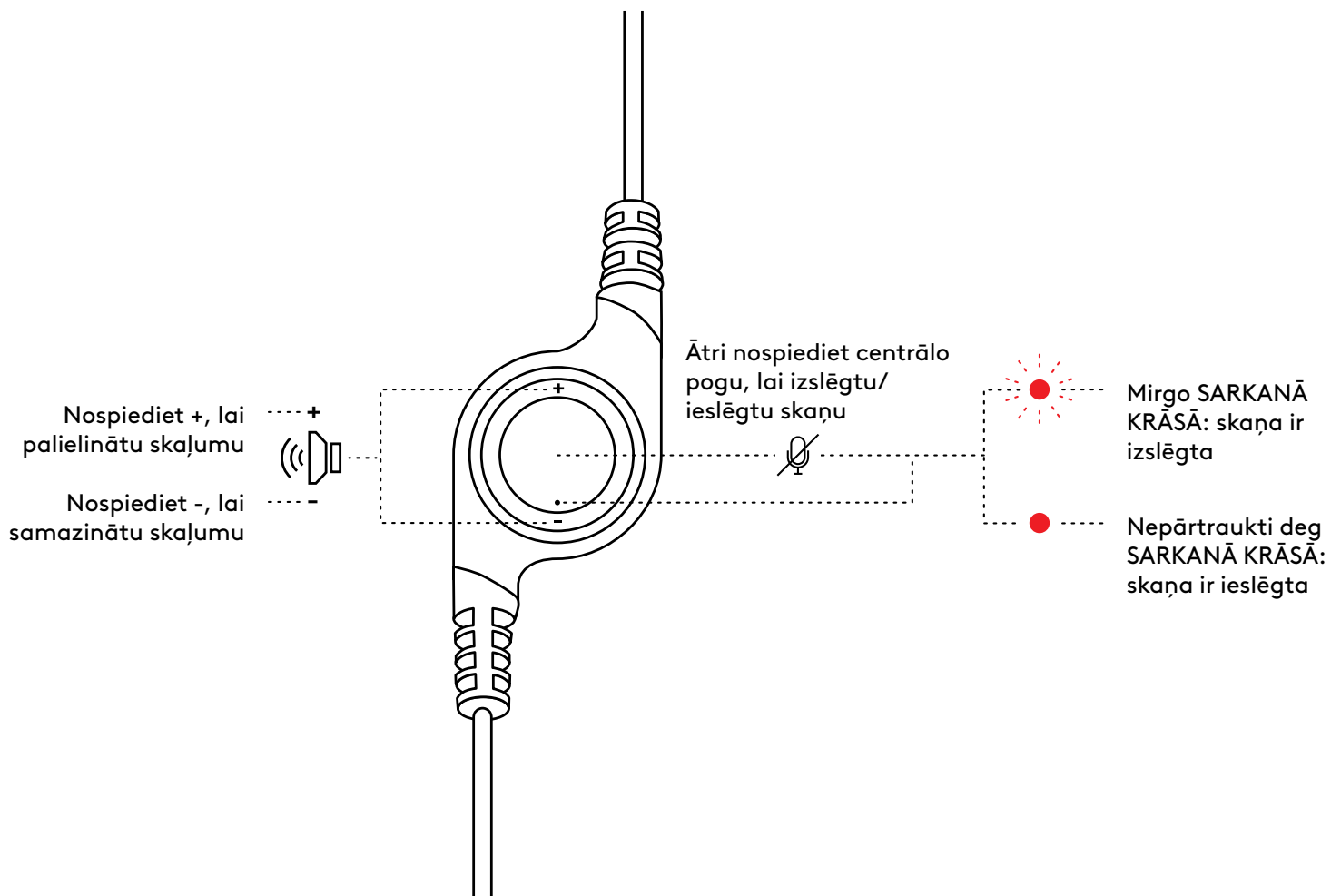

www.logitech.com/support/H390

SUSIPAŽINKITE SU SAVO PRODUKTU

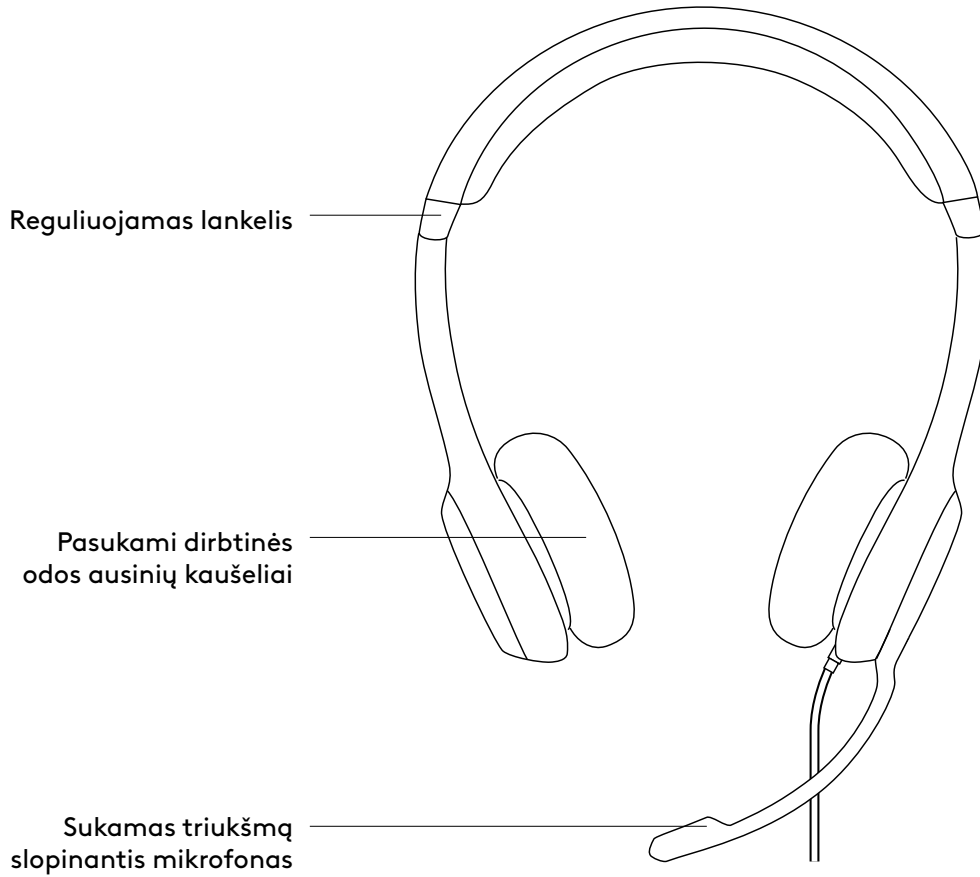

VIENAAILIS VALDIKLIS

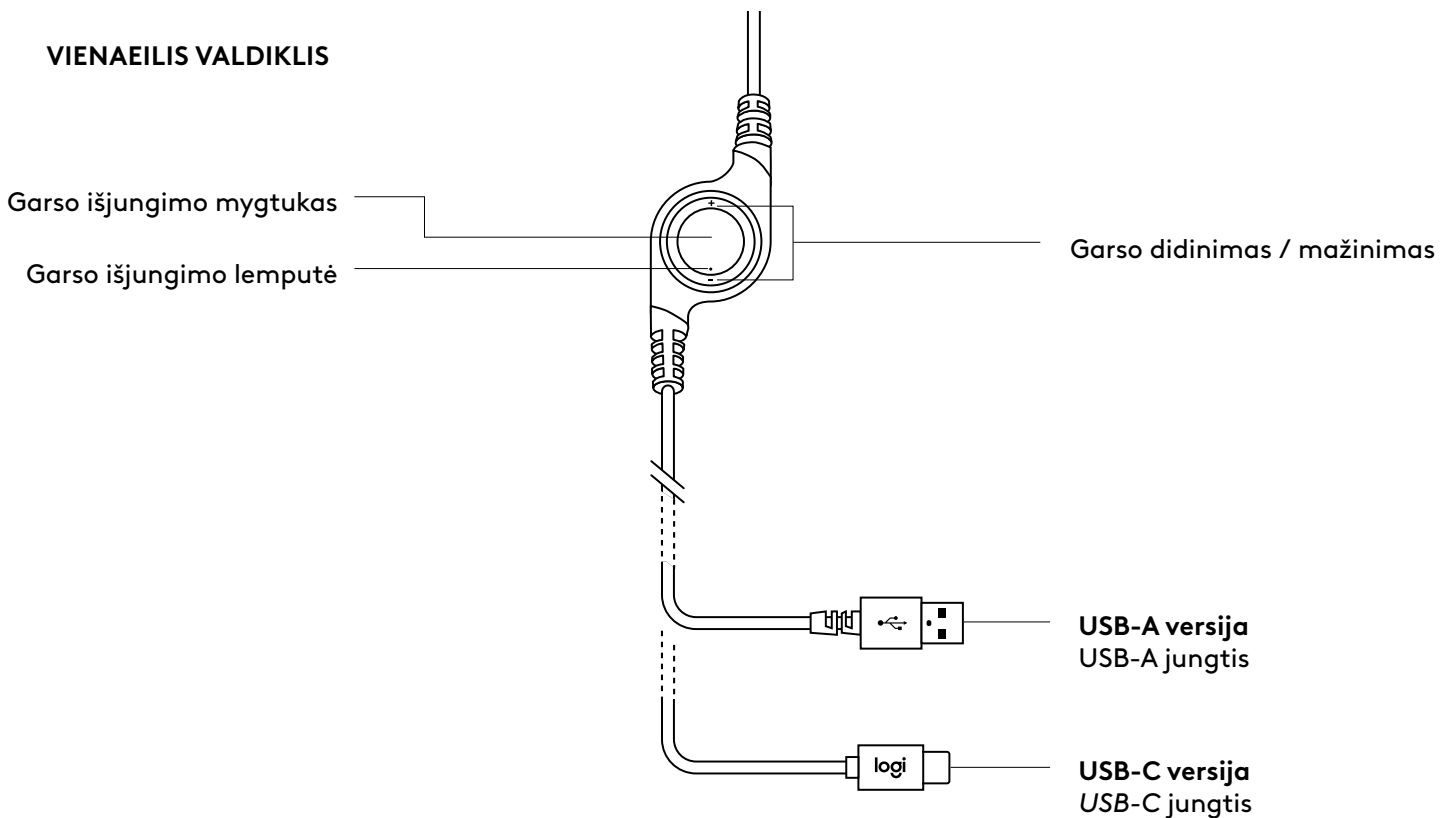

AUSINIŲ PRIJUNGIMAS

Įkiškite USB jungtį į kompiuterio USB prievadą.

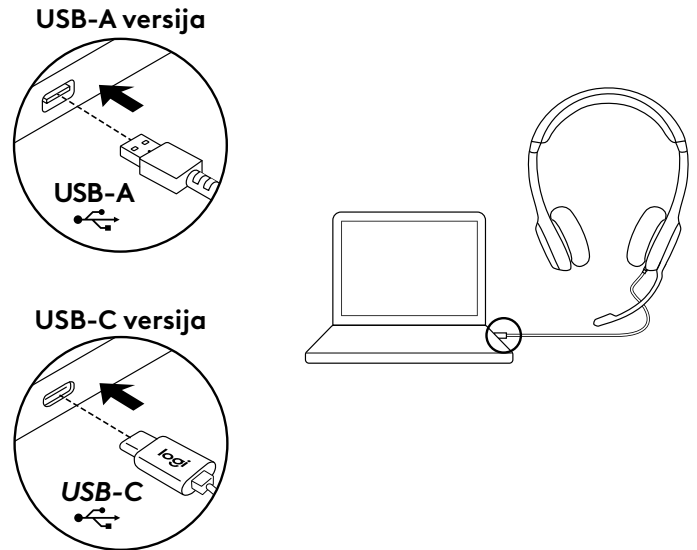

AUSINIŲ SUREGULIAVIMAS

1. Sureguliuokite galvos juostos dydį judindami galvos juostą į viršų ir apačią, kol patogiai tiks.
2. Judinkite mikrofono strėlę į viršų ar apačią, kol ji bus sulig jūsų burna, kad garsas būtų geriau fiksuojamas.
3. Kai nenaudojate, strėlę nusukite toliau.

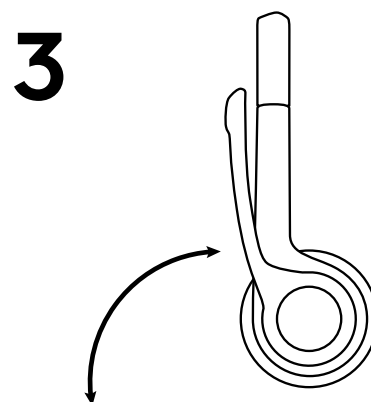
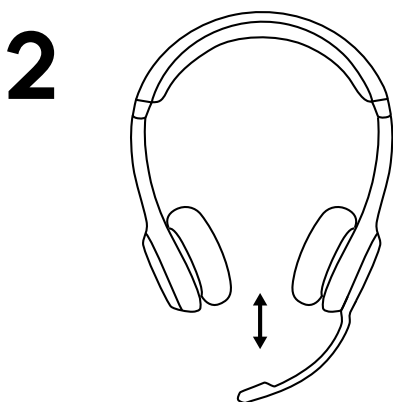
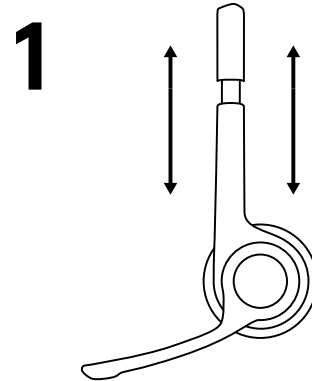

VALDIKLIAI

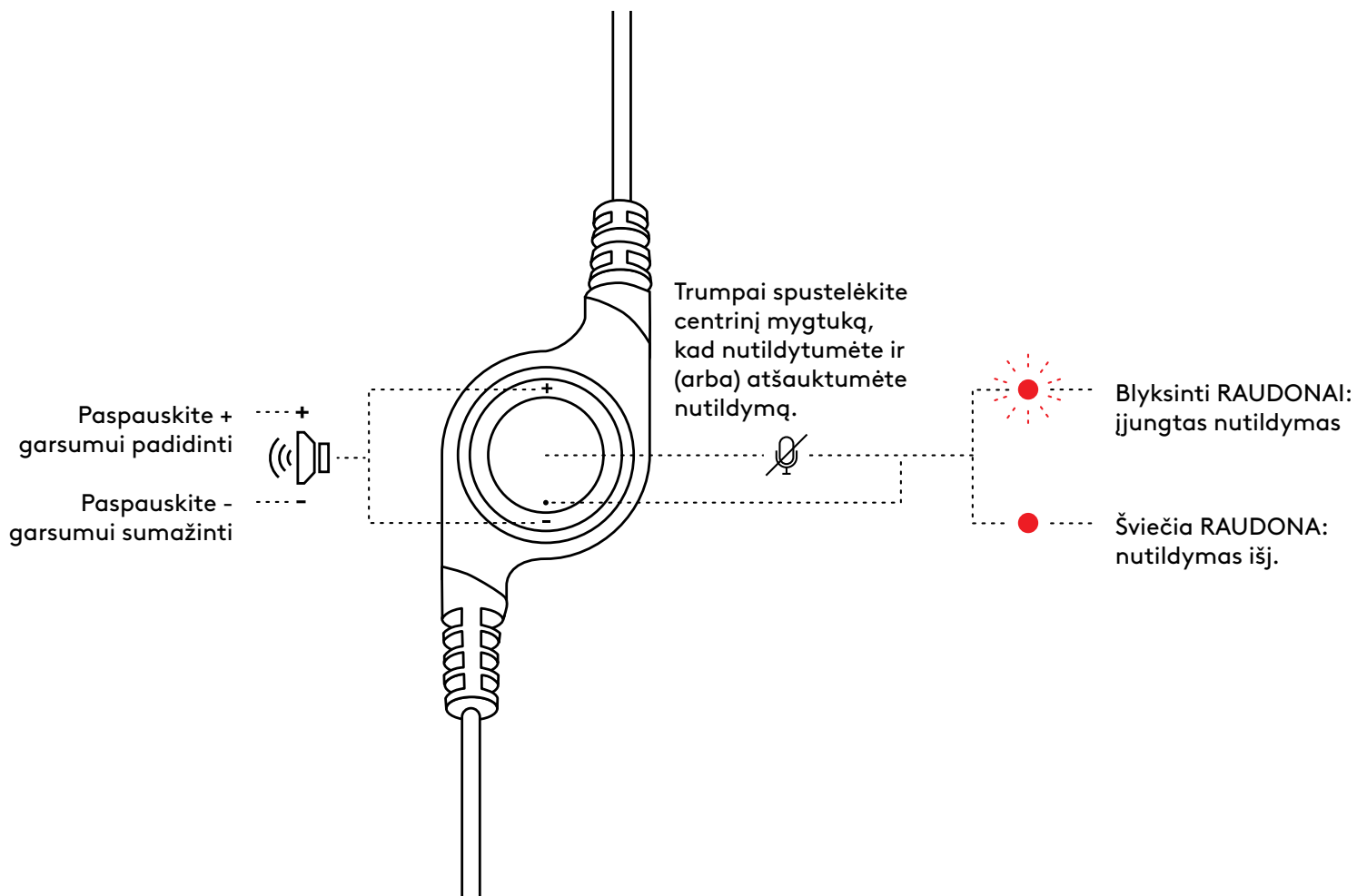

www.logitech.com/support/H390

ЗАПОЗНАЙТЕ СЕ СЪС СВОЯ ПРОДУКТ

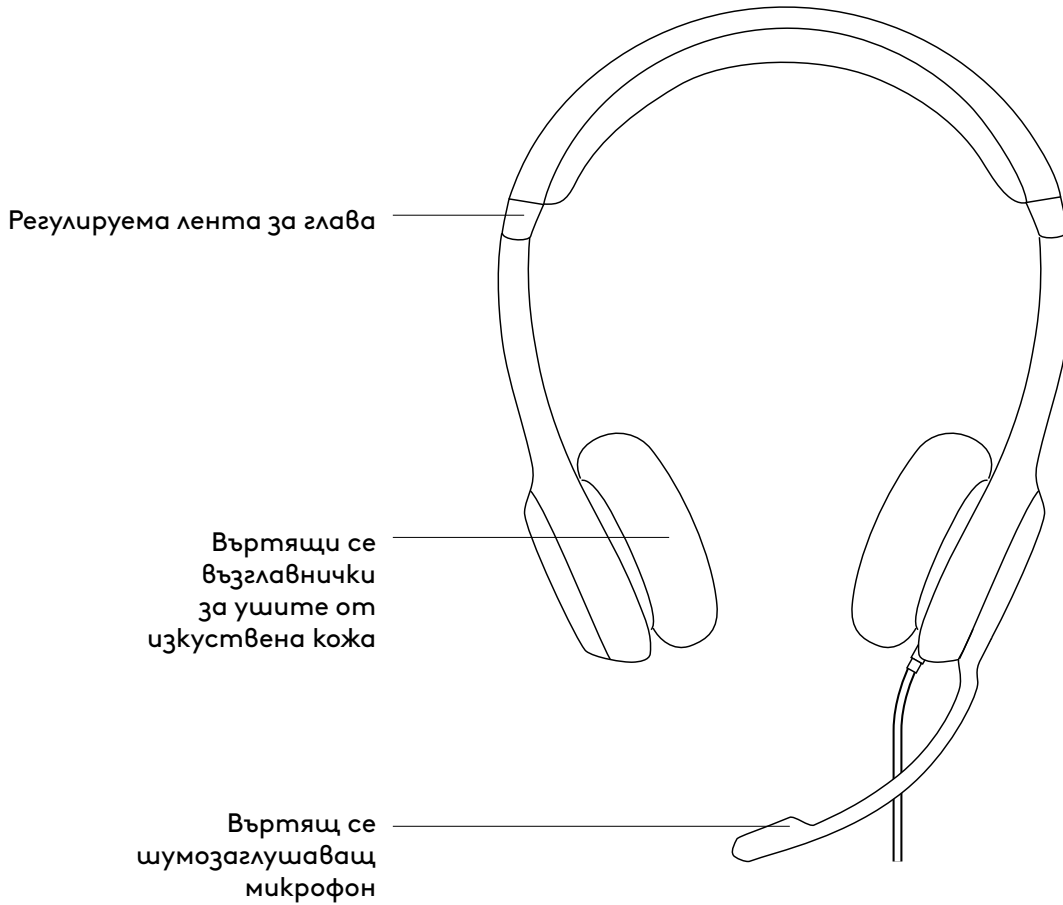

ВГРАДЕН КОНТРОЛЕР

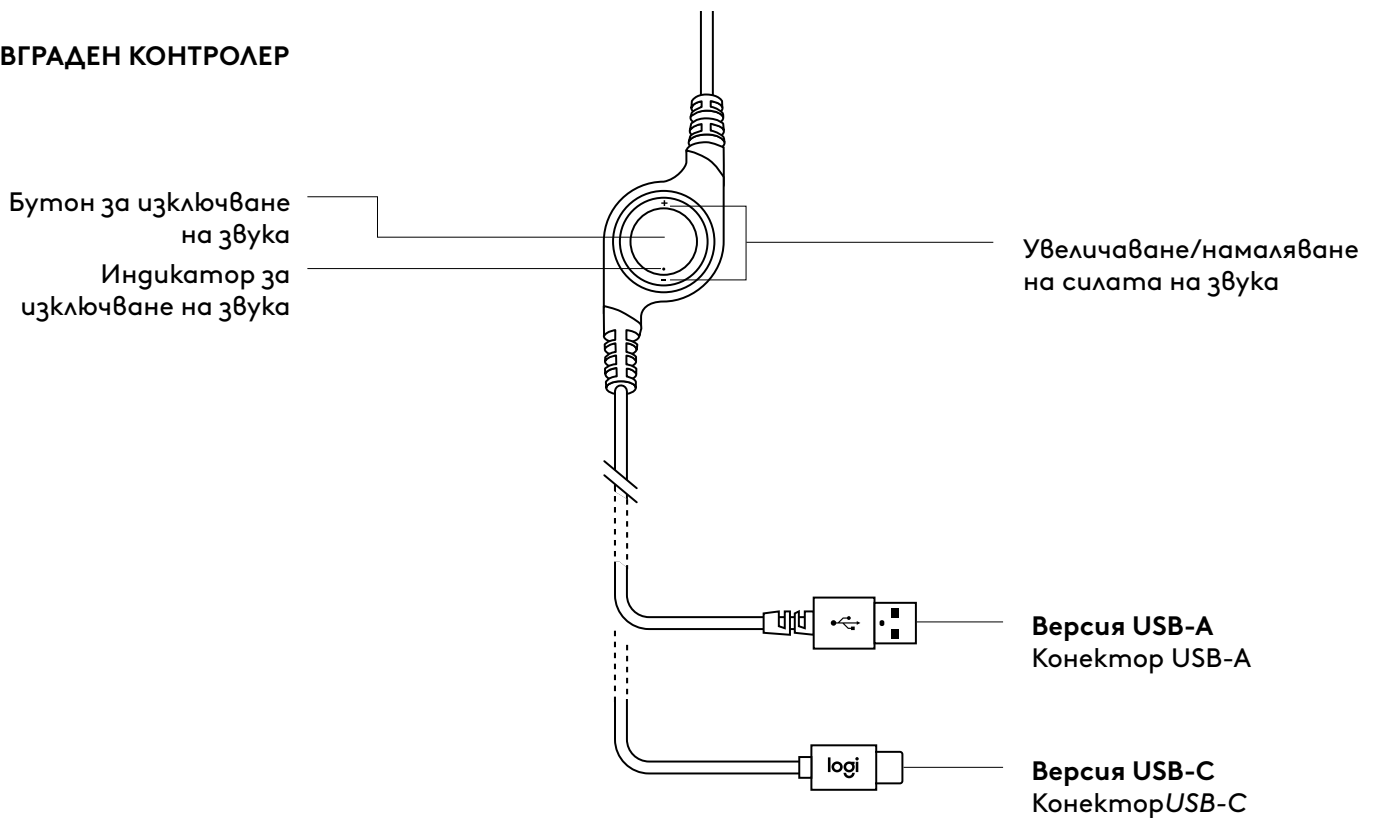

СВЪРЗВАНЕ НА СЛУШАЛКИТЕ

Включете USB конектора към USB порта на компютъра.

USB-A ВЕРСИЯ

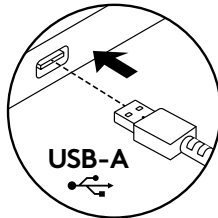

USB-C ВЕРСИЯ

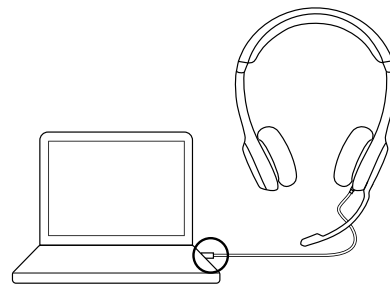
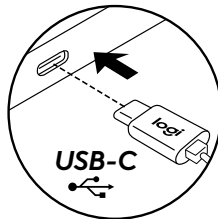

НАПАСВАНЕ НА СЛУШАЛКИТЕ

1. За да регулирате размера на слушалките, движете лентата за глава нагоре и надолу, докато пасне удобно.
2. Движете стойката на микрофона нагоре или надолу, докато не е на нивото на устата ви за по-добро улавяне на гласа.
3. Когато не се използва, стойката на микрофона може да се прибере.

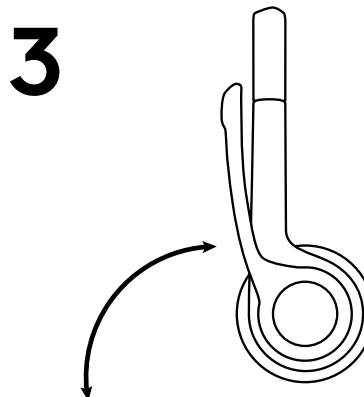
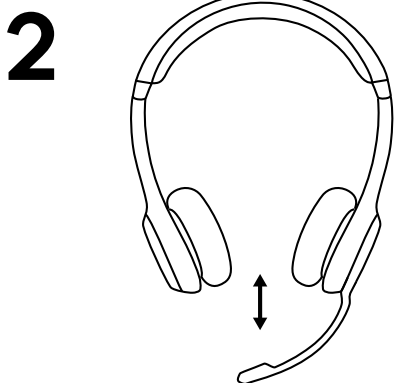
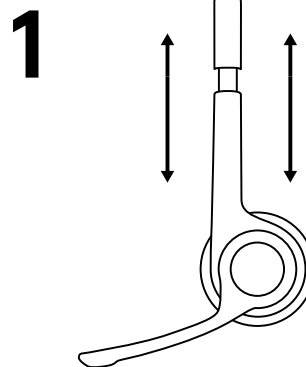

КОНТРОЛИ

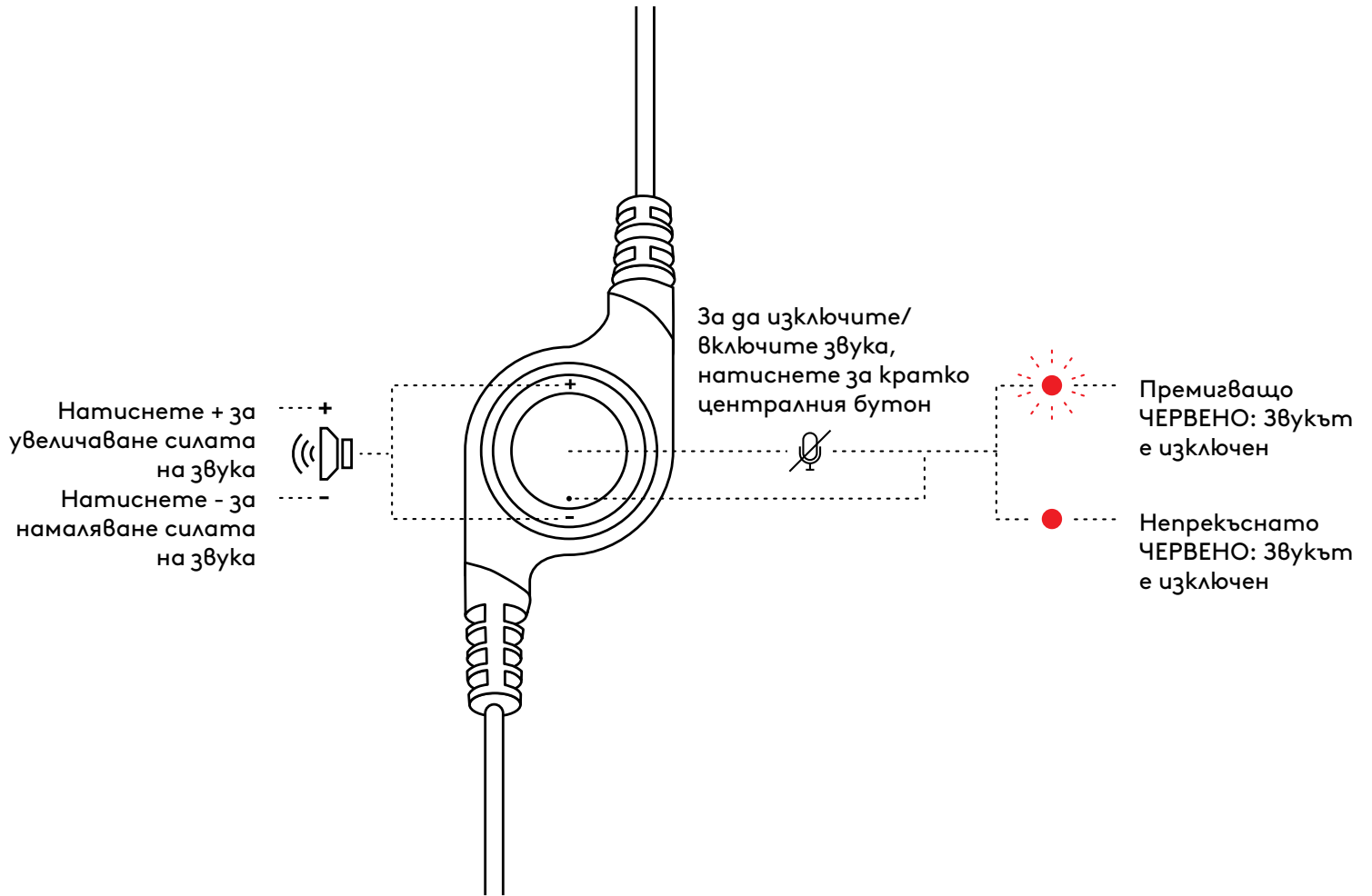

www.logitech.com/support/H390

UPOZNAJTE SVOJ UREĐAJ

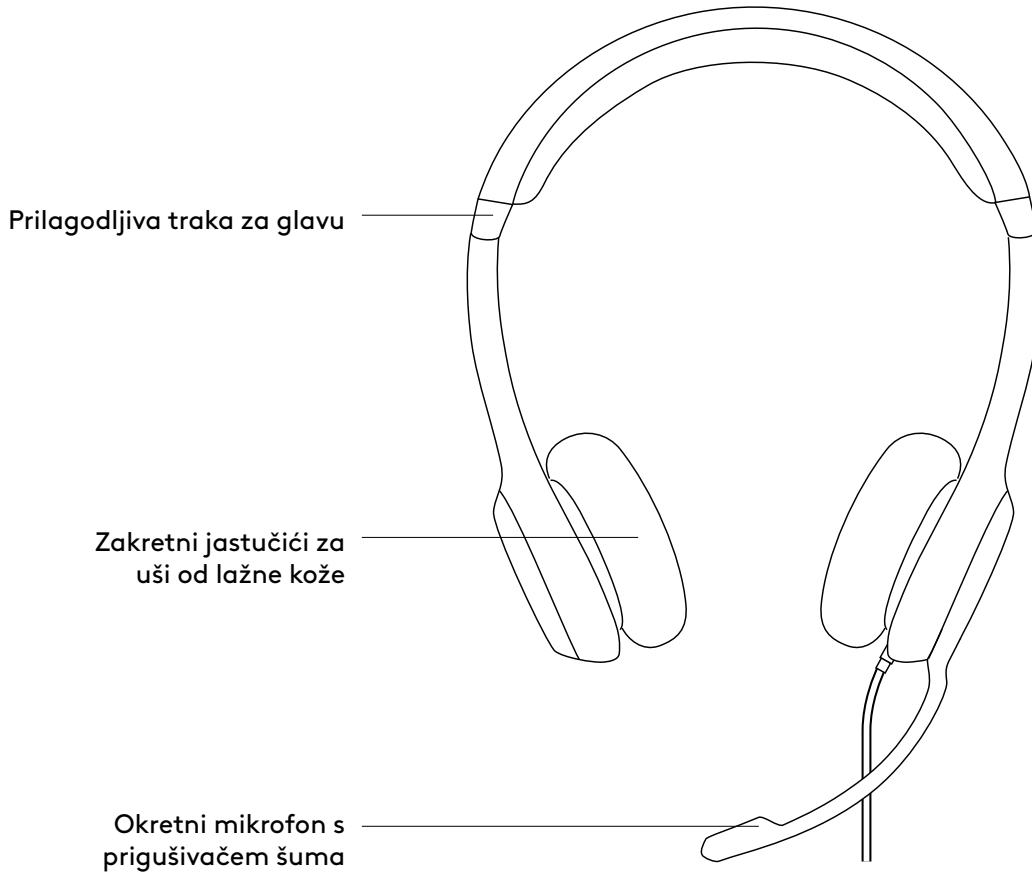

KONTROLER U KABELU

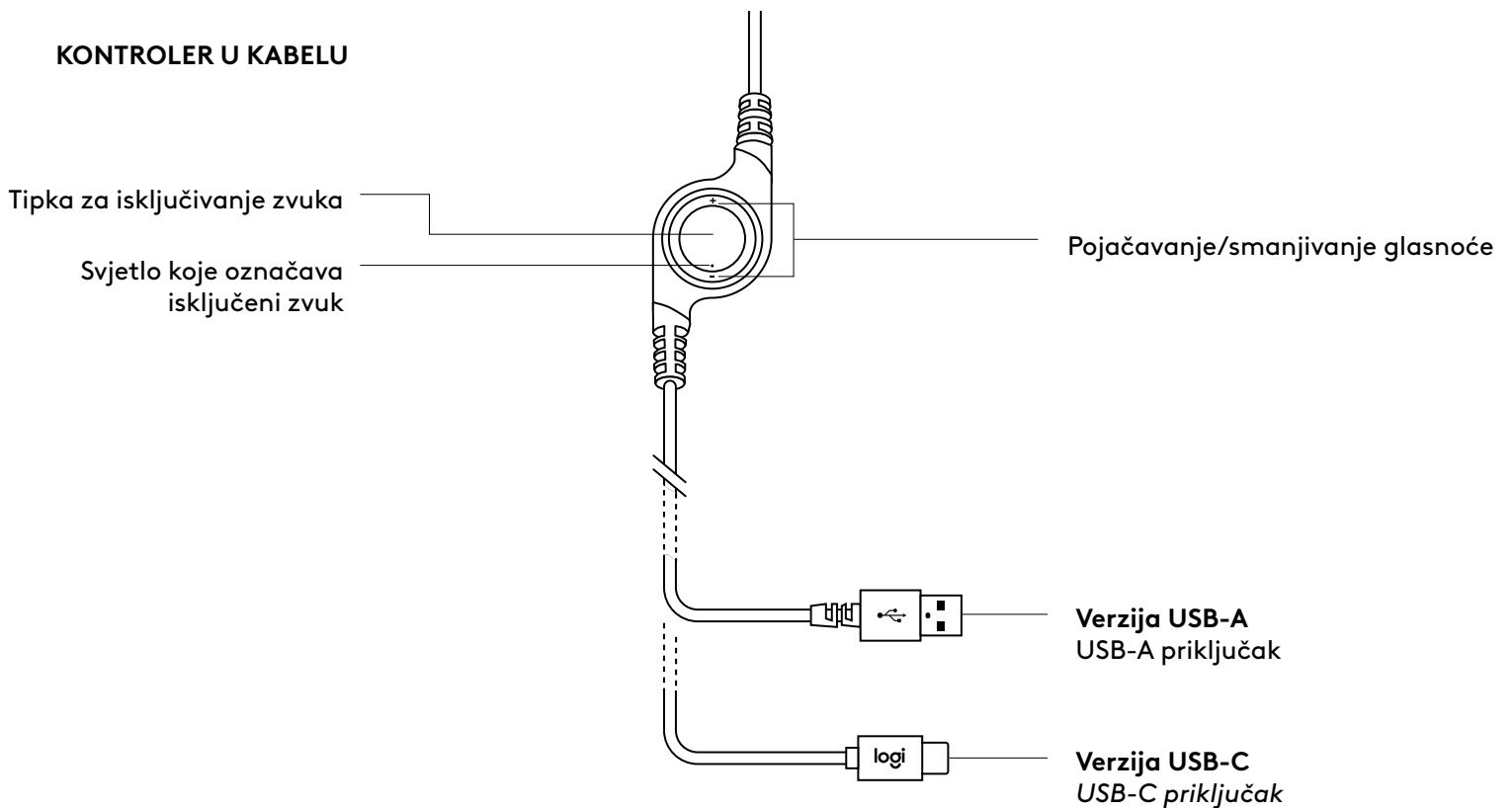

PRIKLJUČIVANJE SLUŠALICA

Ukopčajte USB priključak u USB priključnicu na računalu.

VERZIJA USB-A

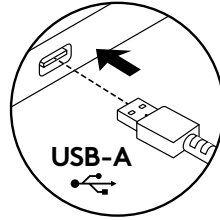

VERZIJA USB-C

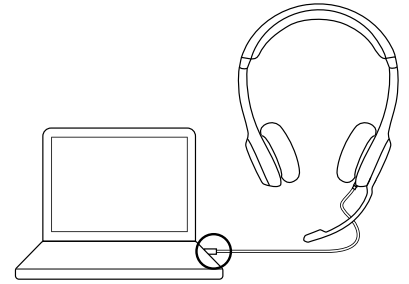
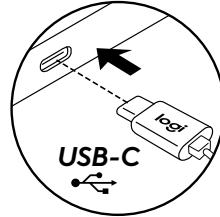

NAMJEŠTANJE SLUŠALICA

1. Ako želite prilagoditi veličinu slušalica, pomičite traku za glavu gore i dolje da vam udobno prisjedaju.
2. Pomaknite ovjes mikrofona gore ili dolje kako bi bio u ravni s vašim ustima za bolje hvatanje glasa.
3. Nosač se može odmaknuti da vam ne smeta kada ga ne upotrebljavate.

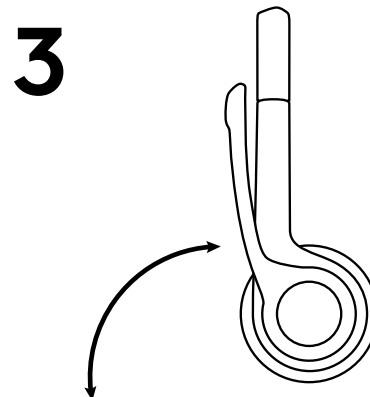
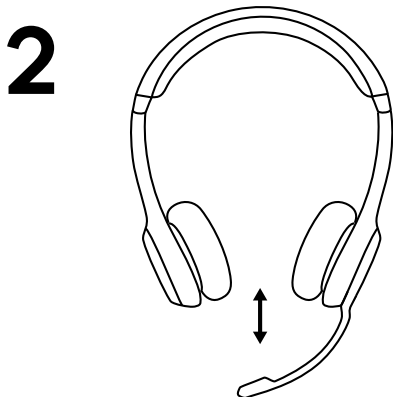
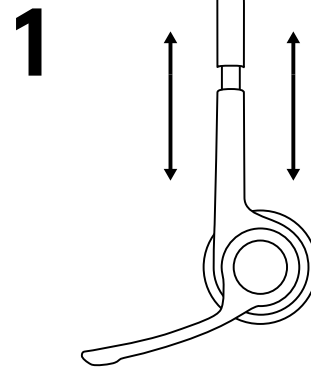

UPRAVLJANJE

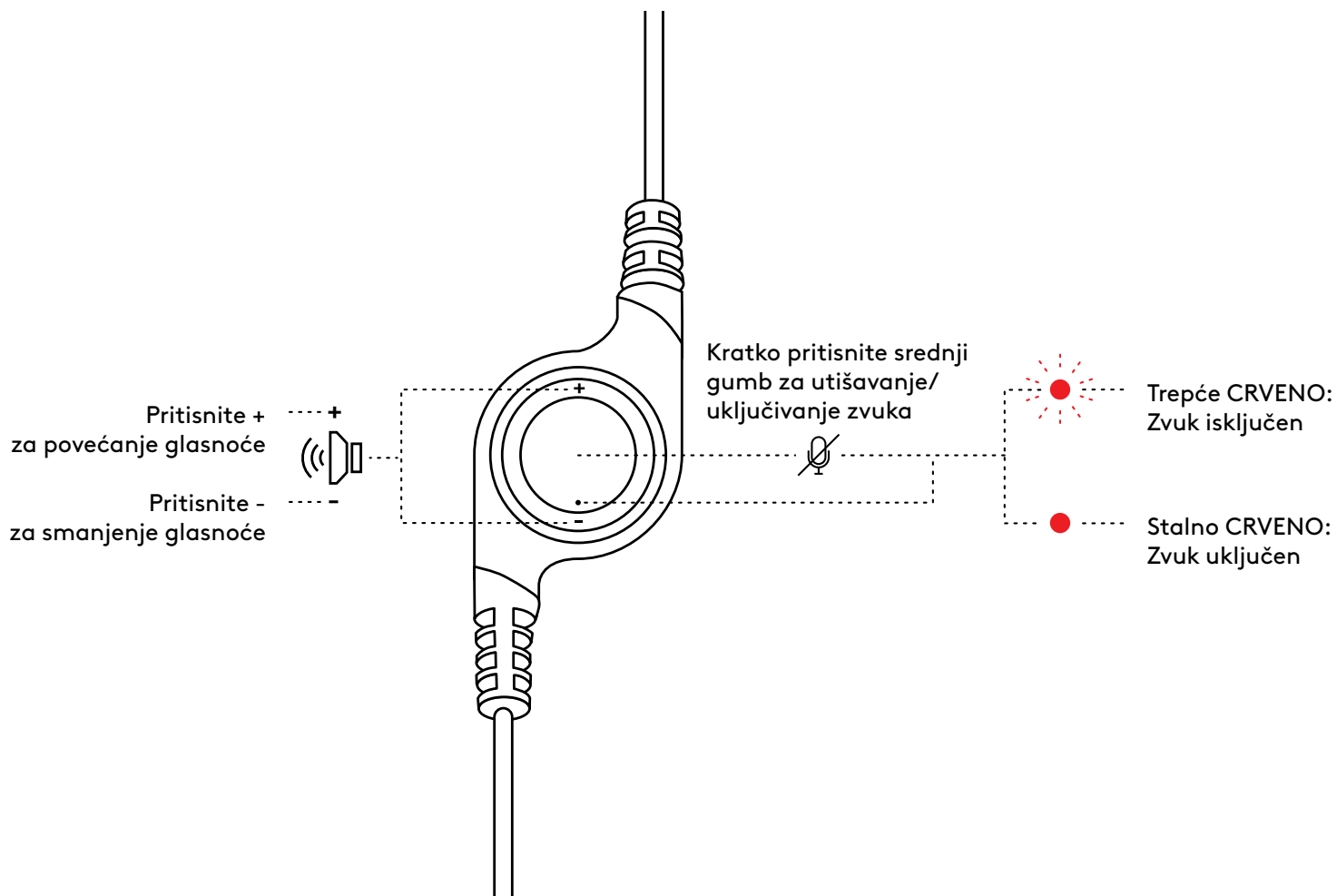

www.logitech.com/support/H390

UPOZNAJTE SVOJ PROIZVOD

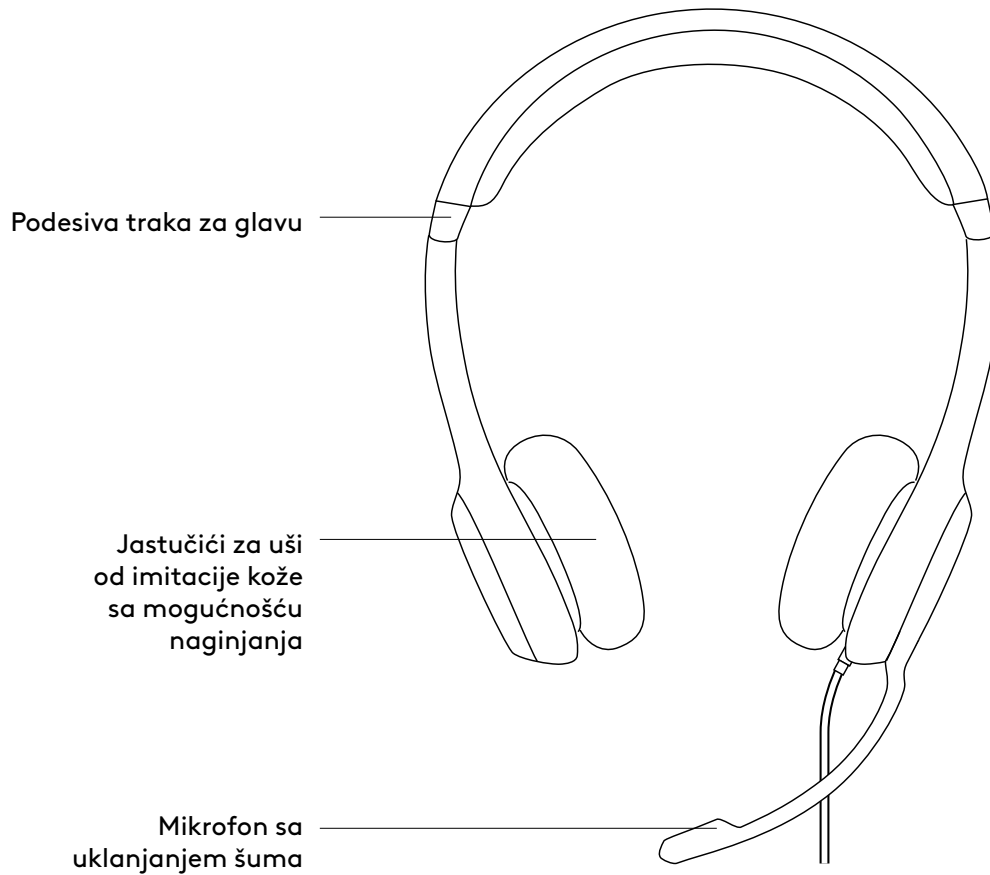

UGRAĐENI KONTROLER

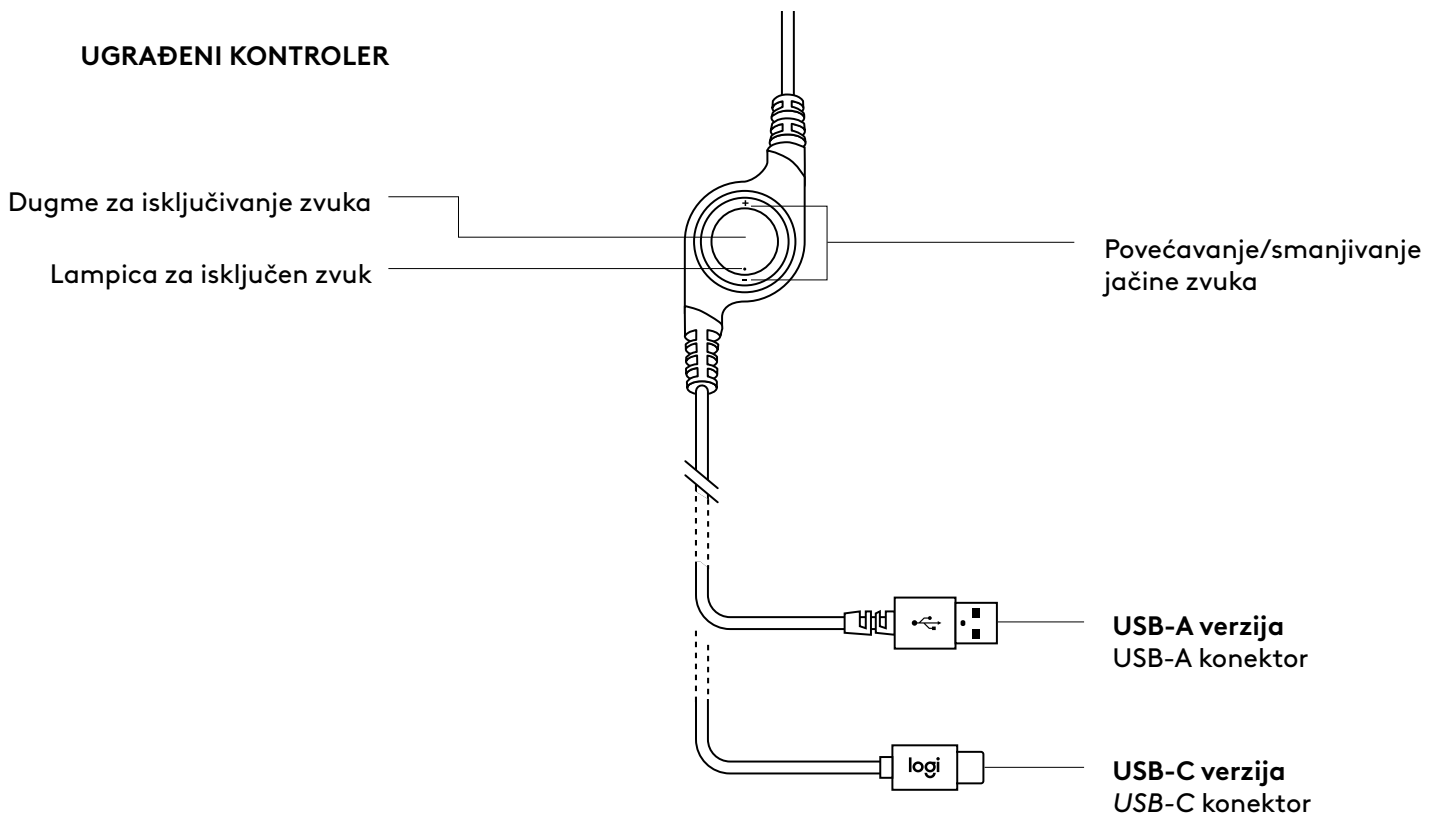

POVEZIVANJE SLUŠALICA

Priključite USB konektor u USB port na računaru.

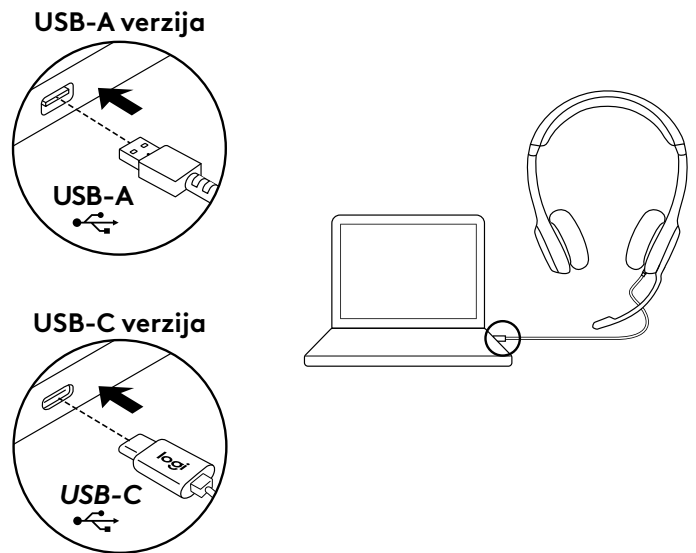

PRILAGOĐAVANJE SLUŠALICA

1. Da biste podesili veličinu slušalica, pomerajte traku za glavu gore-dole dok je ne namestite udobno.
2. Pomerajte krak mikrofona gore-dole dok ne bude u nivou vaših usta, za bolje snimanje zvuka.
3. Držać možete da sklonite ako ga ne koristite.

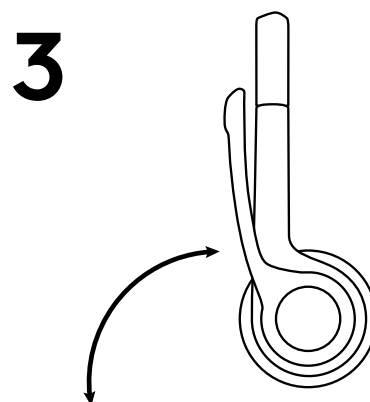
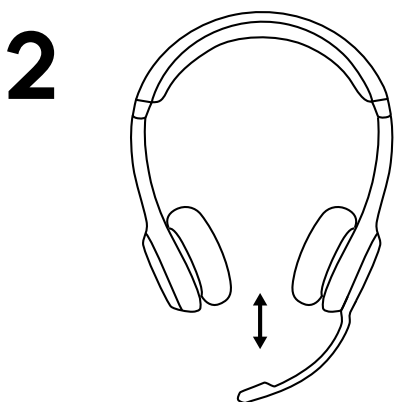
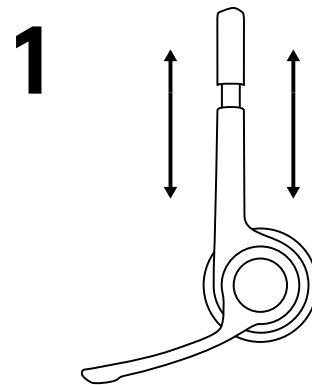

KONTROLE

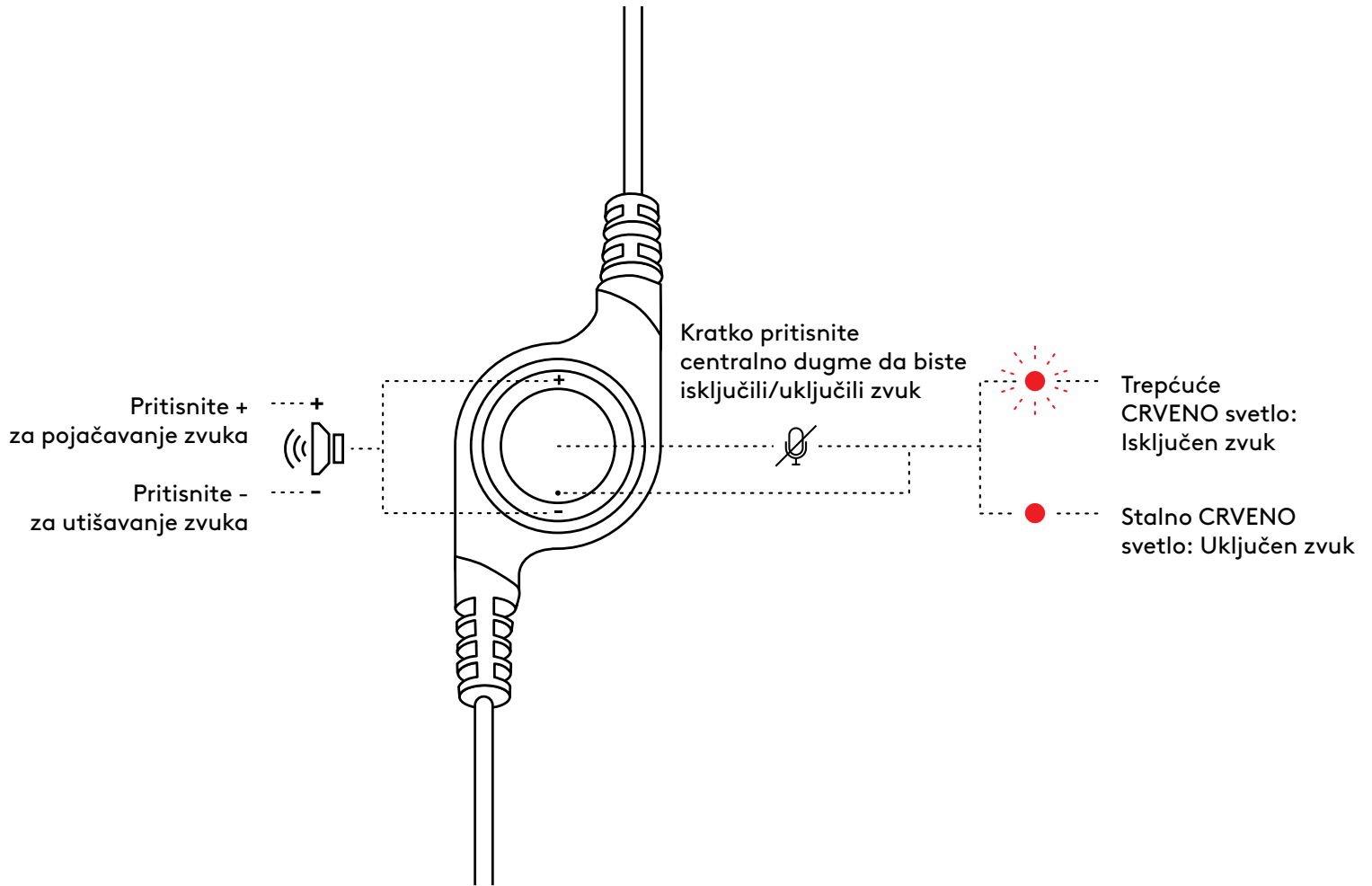

www.logitech.com/support/H390

SPOZNAJTE IZDELEK

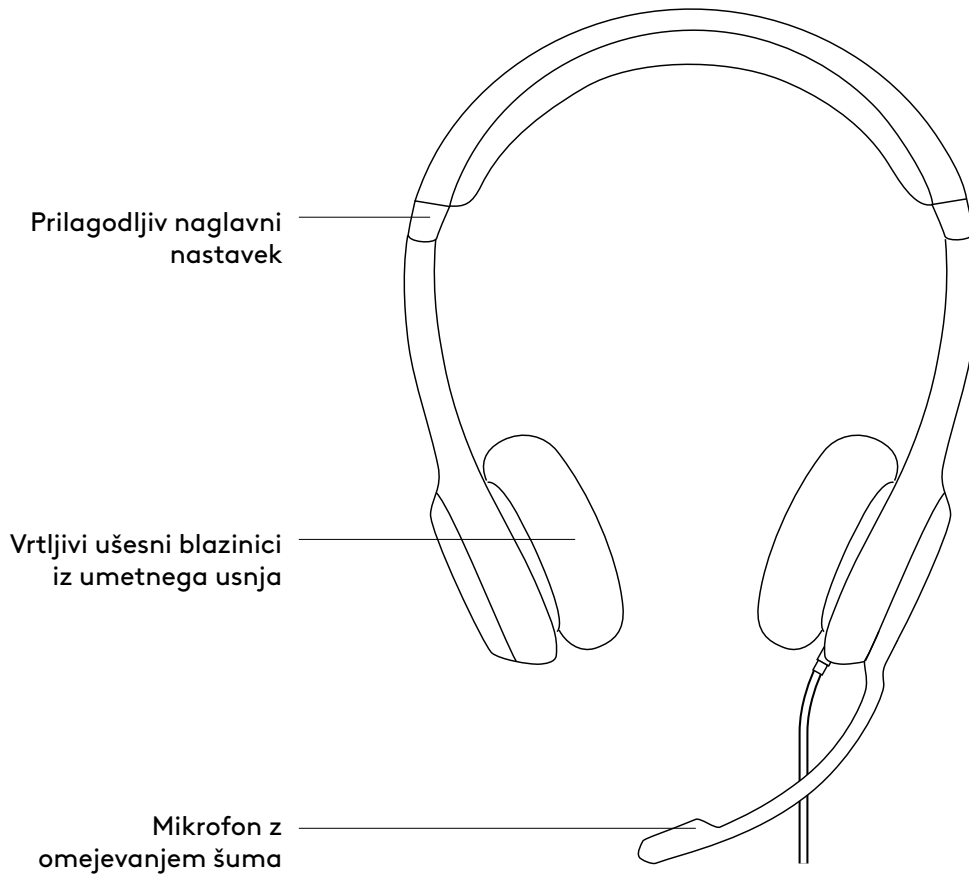

KRMILNIK, VGRAJEN NA KABEL

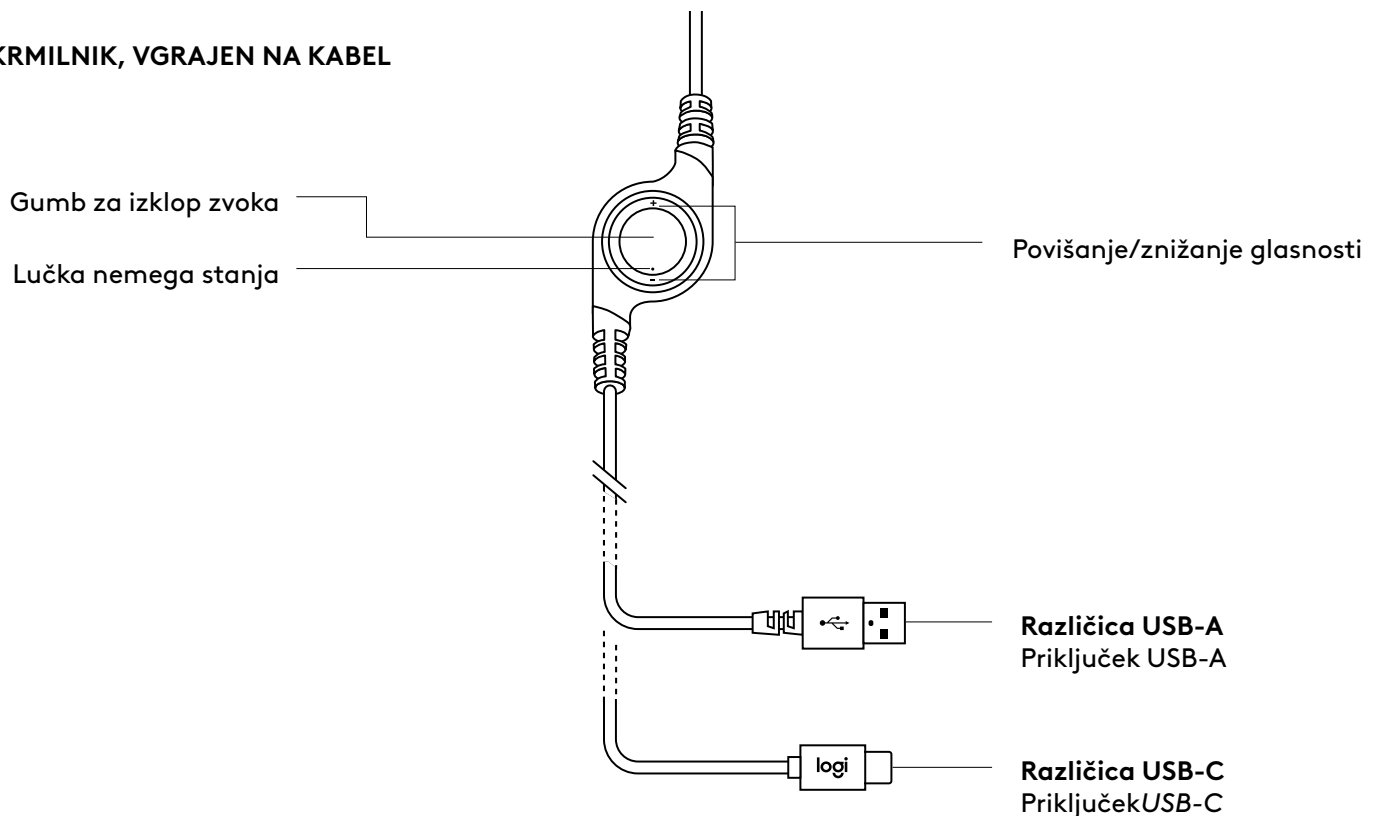

PRIKLJUČITEV SLUŠALK

Priključek USB priključite v vrata USB na računalniku.

Različica USB-A

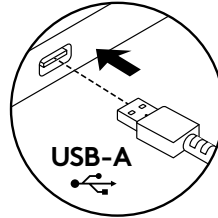

Različica USB-C

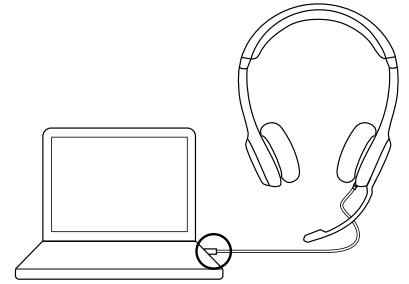
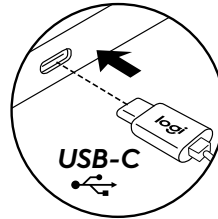

NASTAVITEV SLUŠALK

1. Da prilagodite velikost slušalk, naglavni nastavek pomikajte navzgor ali navzdol, dokler se udobno ne prilega.
2. Da zagotovite boljši zajem glasu, mikrofona pomaknite navzgor ali navzdol, tako da je v višini ust.
3. Ko mikrofona ne uporabljate, lahko držalo zložite, da vam ne bo v napoto.

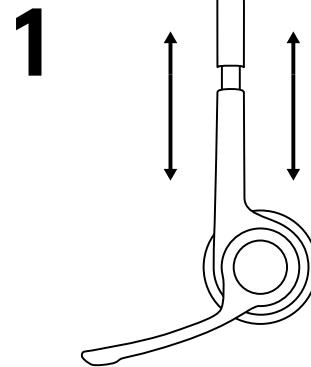

2

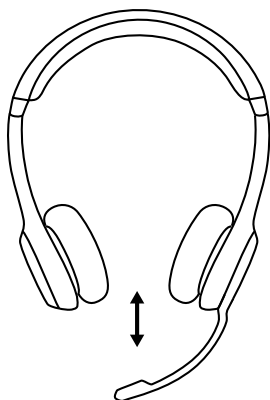

3

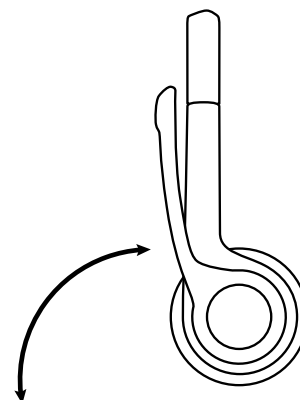

KONTROLNIKI

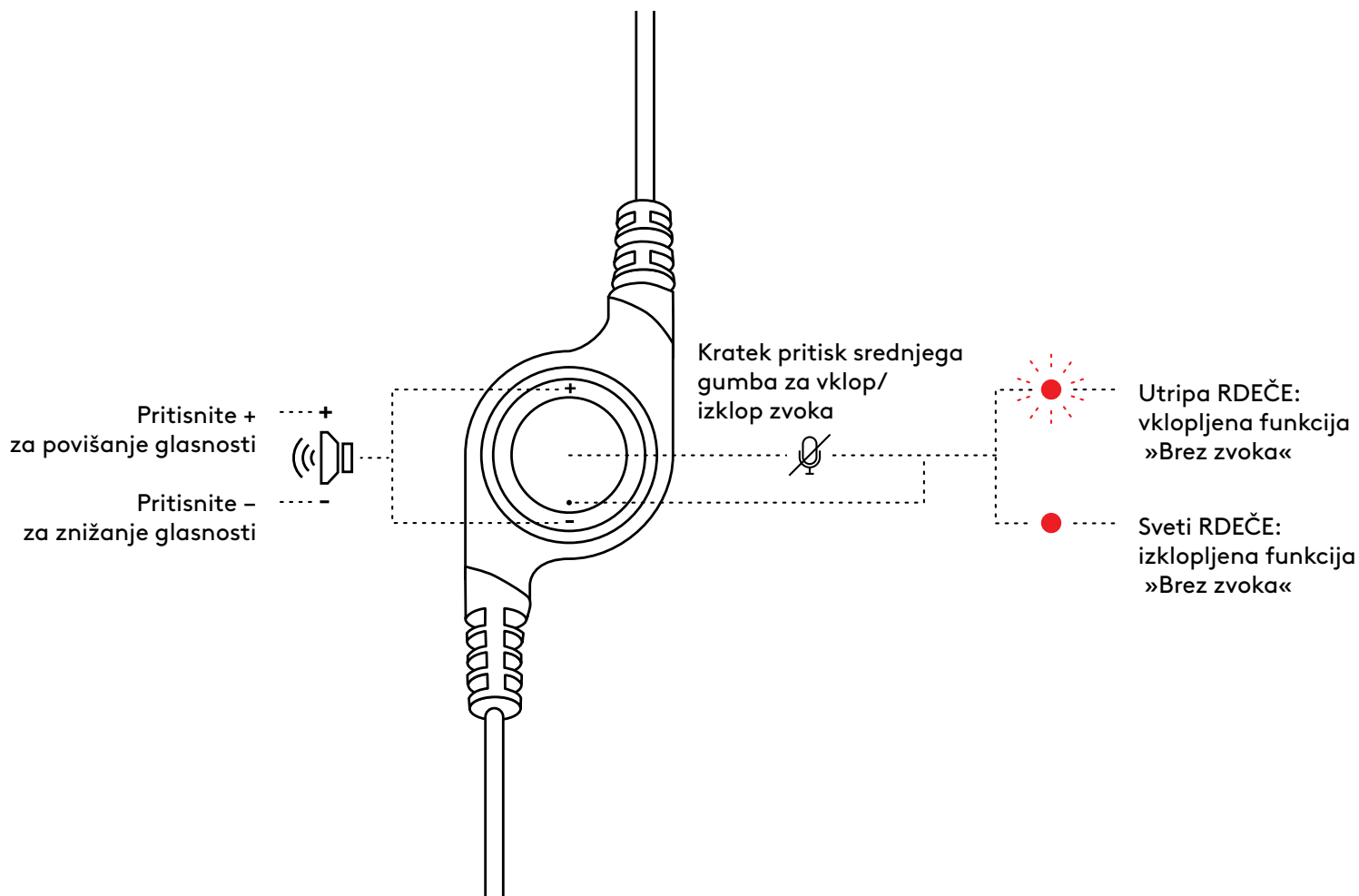

www.logitech.com/support/H390

FAMILIARIZAȚI-VĂ CU PRODUSUL

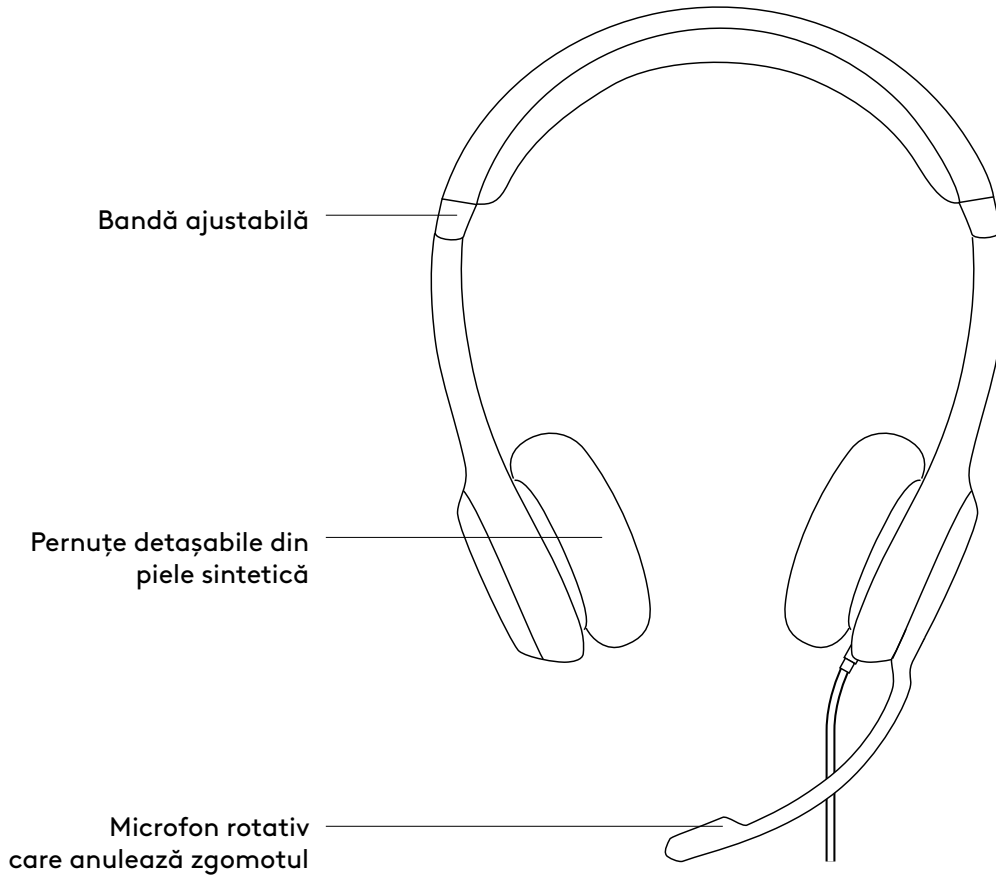

CONTROLER PE FIR

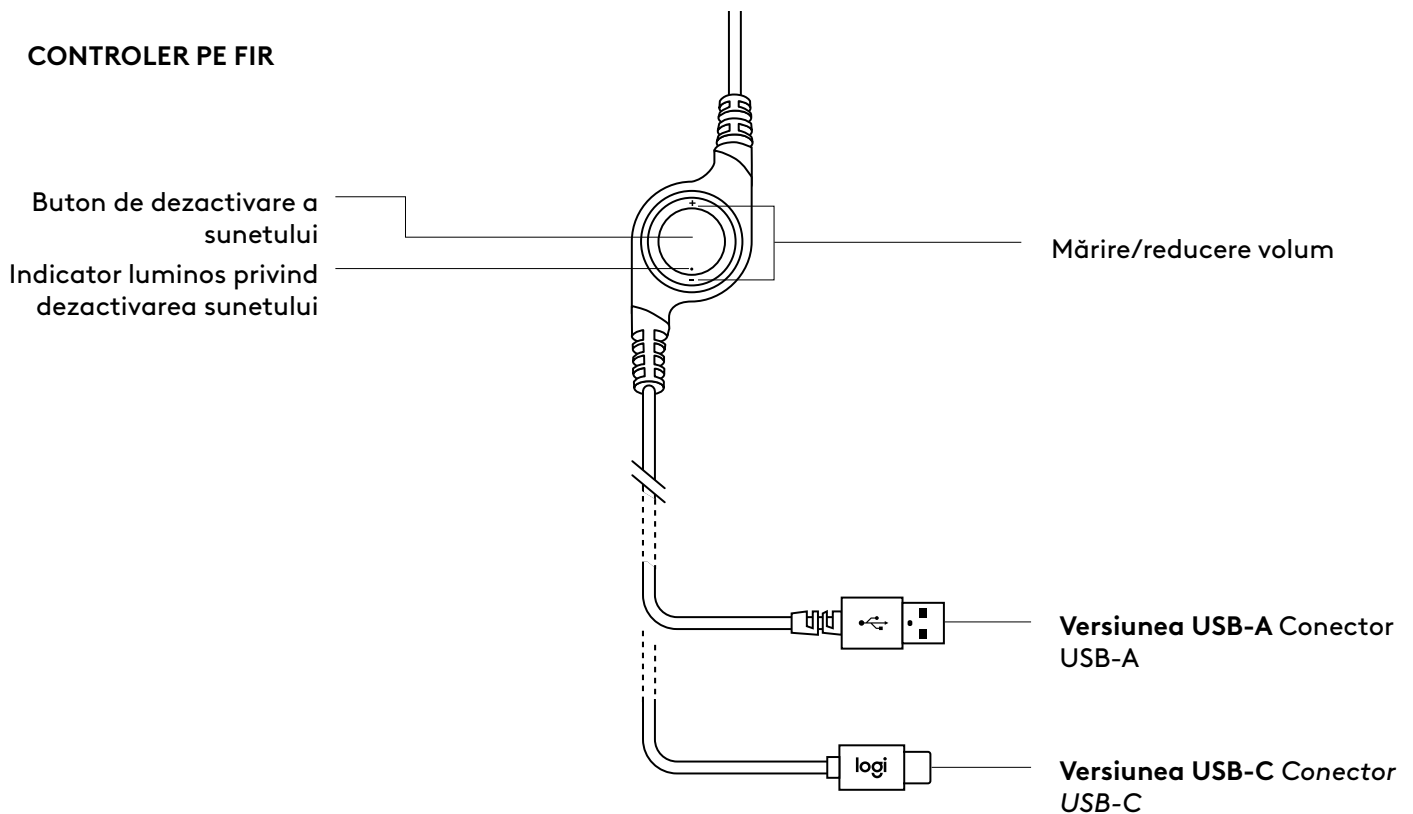

CONECTAREA CĂȘTILOR

Conectați conectorul USB la portul USB al computerului.

Versiunea USB-A

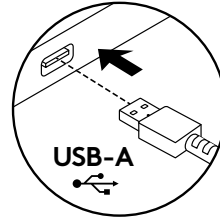

Versiunea USB-C

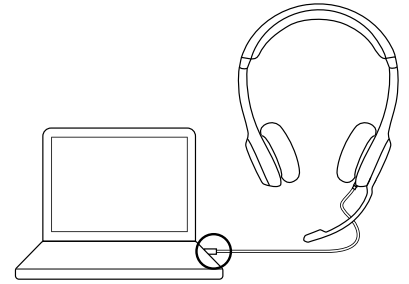
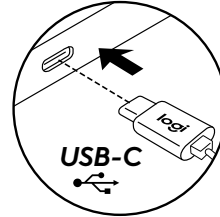

AJUSTAREA CĂȘTILOR

1. Pentru a ajusta dimensiunea căștilor, deplasați-le în sus și în jos până când se poziționează confortabil.
2. Mutați brațul microfonului în sus sau în jos până când ajunge în dreptul gurii, pentru a capta mai bine vocea.
3. Brațul microfonului poate fi îndepărtat când nu îl folosiți.

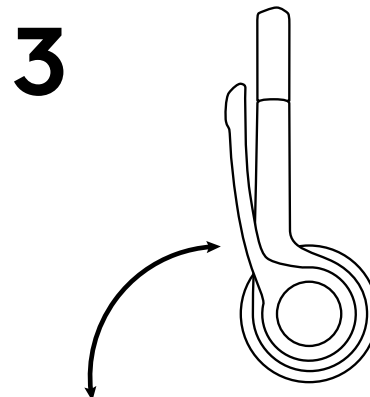
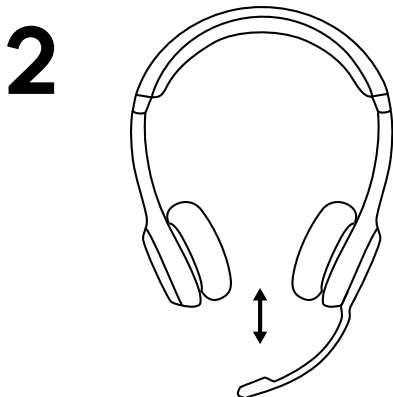
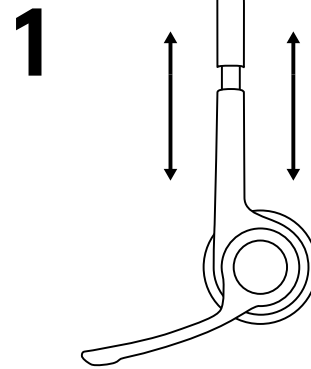

COMENZI

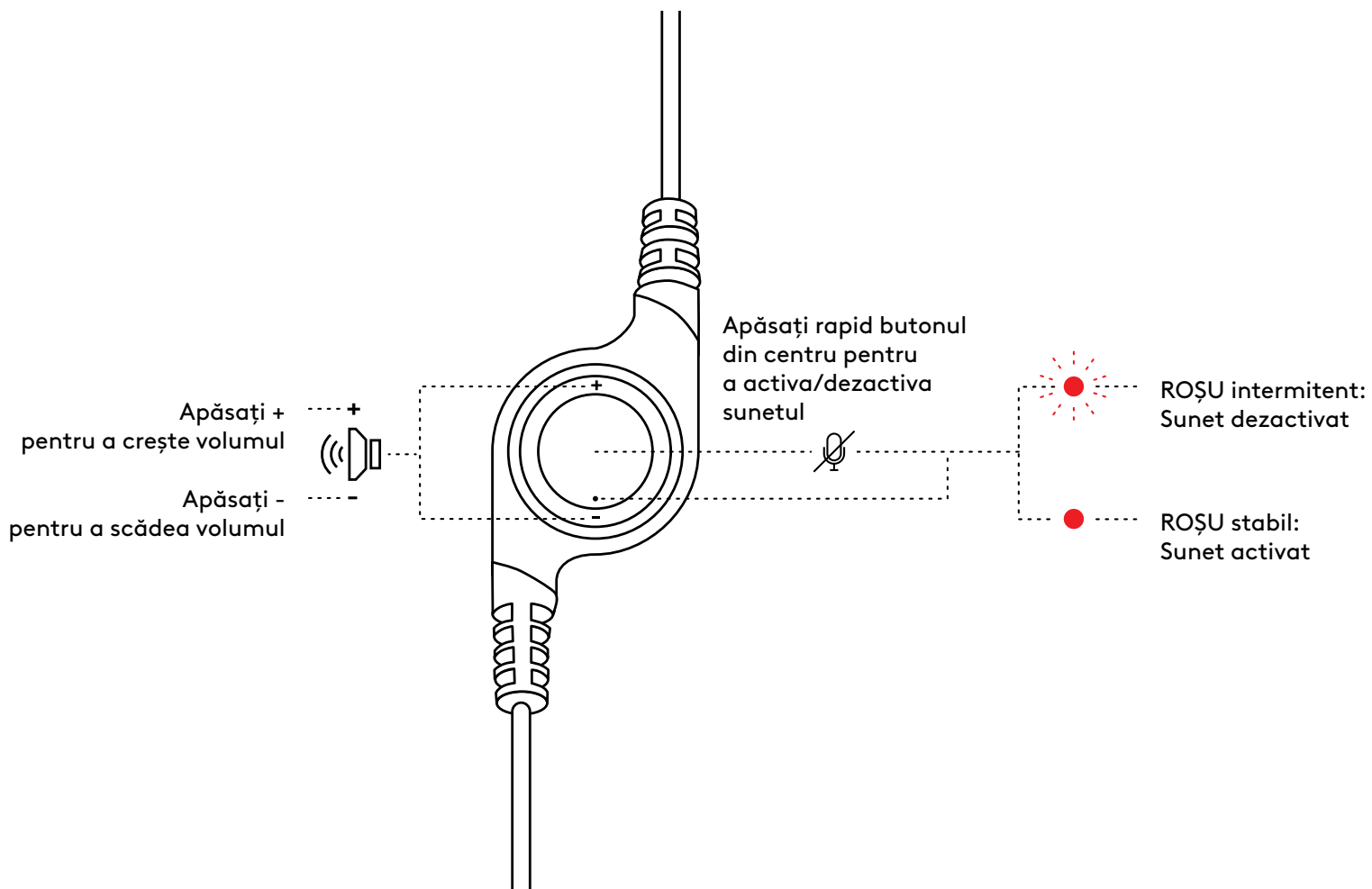

www.logitech.com/support/H390

ÜRÜNÜNÜZÜ TANIYIN

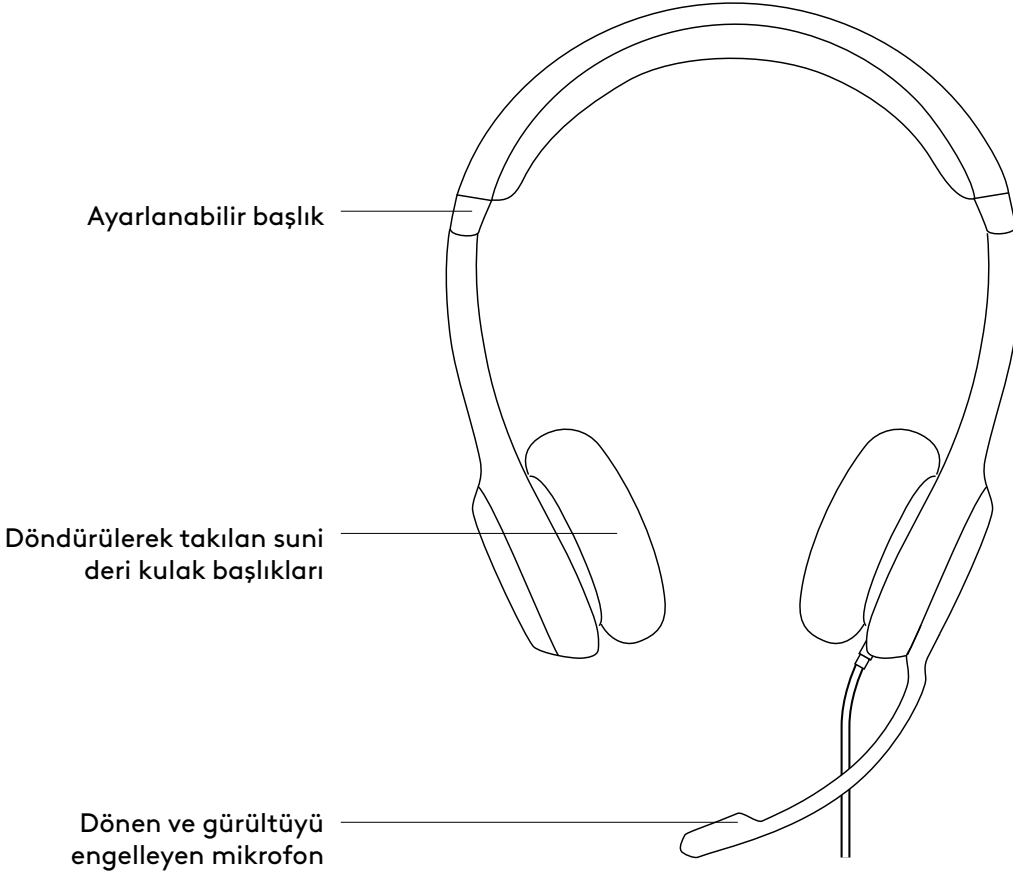

KABLO ÜZERİ DENETLEYİCİ

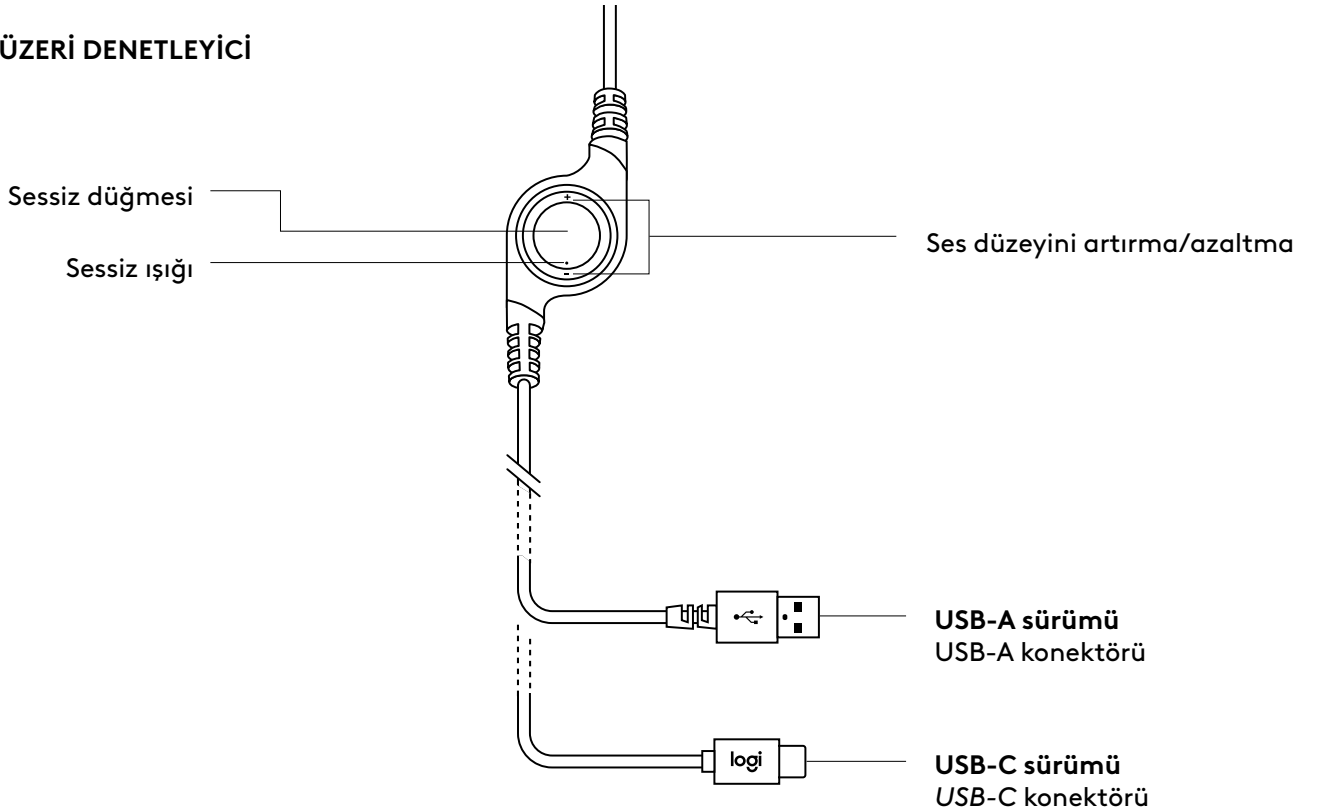

KULAKLIĞI BAĞLAMA

USB-A konektörünü bilgisayarın USB bağlantı noktasına takın.

USB-A sürümü

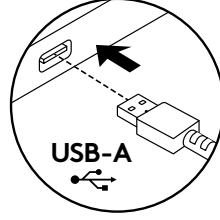

USB-C sürümü

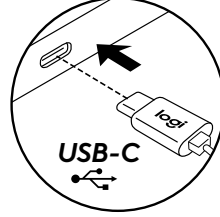

KULAKLIĞI YERLEŞTİRME

1. Kulaklık boyutunu ayarlamak için, başlığı aşağı ve yukarı oynatıp rahat şekilde oturacağı konumu bulun.
2. Daha iyi ses yakalayabilmesi için mikrofon kolunu aşağı ve yukarı oynatarak ağız seviyesine getirin.
3. Mikrofon kolu, kullanmadığınız zamanlarda önünüzü kapatmaması için gizlenebilir.

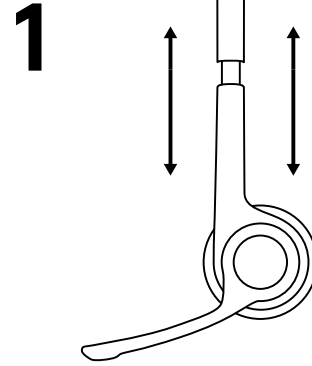

2

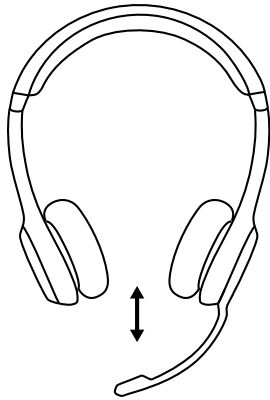

3

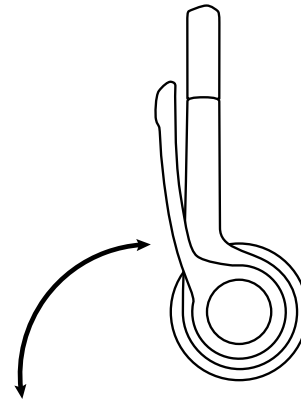

DENETİMLER

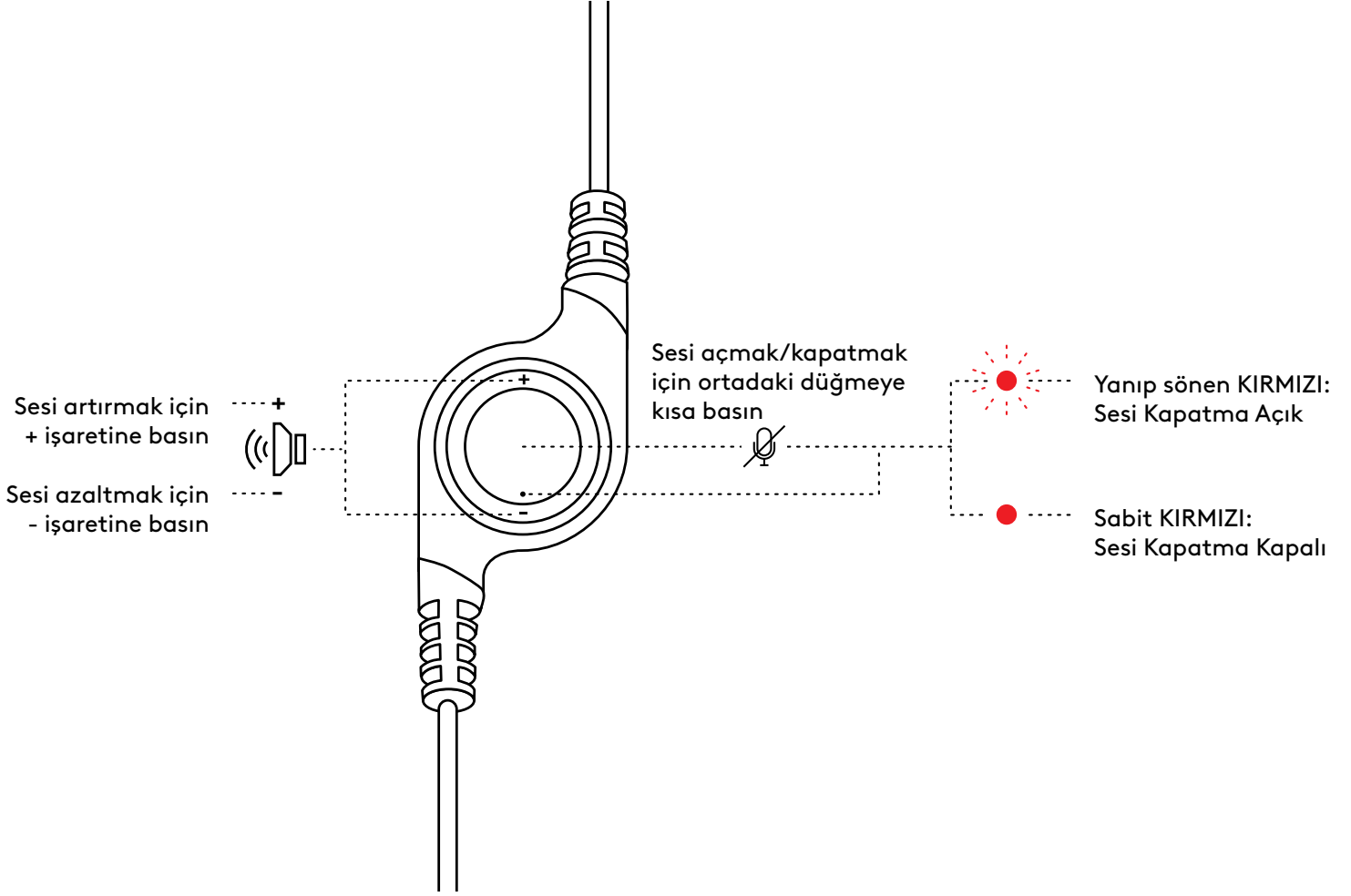

www.logitech.com/support/H390

تعرف على المنتج



وحدة تحكم داخلية

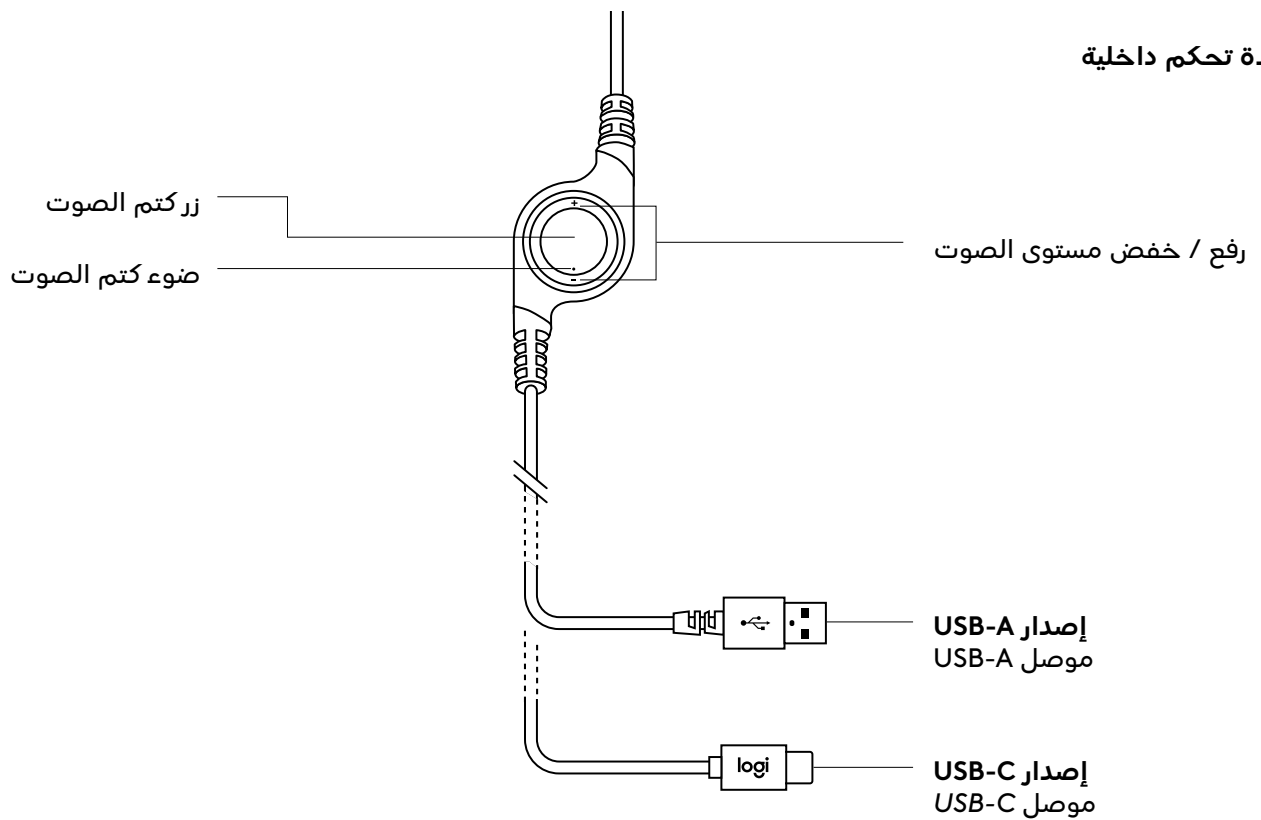

توصيل سماعة الرأس

أدخل موصل USB في منفذ USB بجهاز الكمبيوتر.

إصدار USB-A

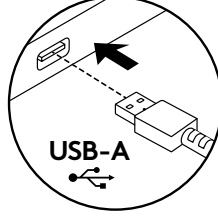

إصدار USB-C

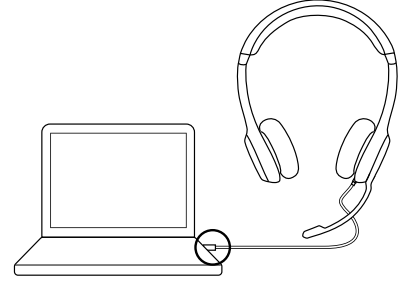
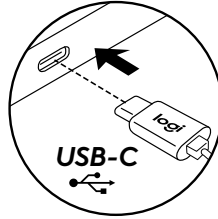

تكييف سماعة الرأس

1. لضبط حجم سماعة الرأس، حرّك عصابة الرأس لأعلى ولأسفل حتى تصبح مريحة.
2. حرّك رأس الميكروفون لأعلى أو لأسفل وللداخل أو للخارج حتى يكون مستويًا عند الفم لالتقاط الصوت بشكل أفضل.
3. يمكن طي الذراع عند عدم استخدامه.

1

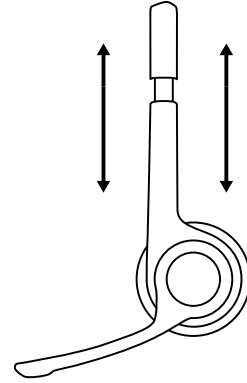

2

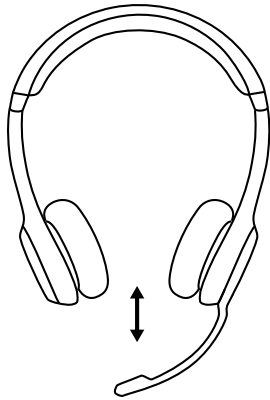

3

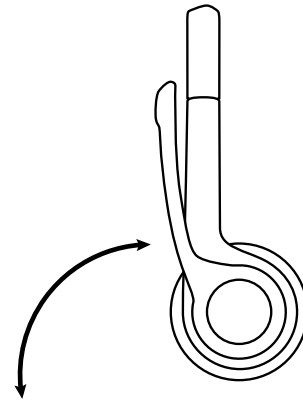

عناصر التحكم

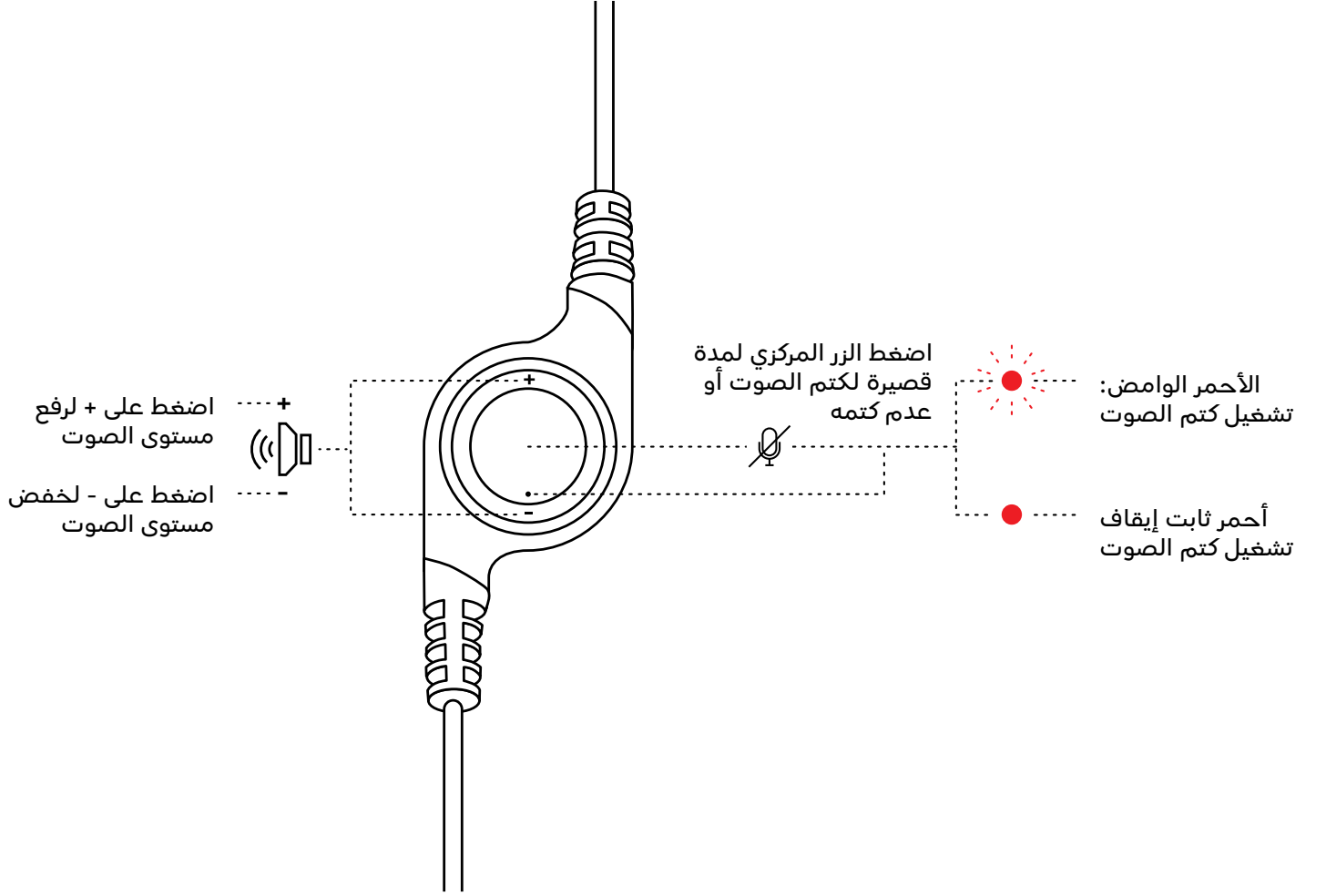

www.logitech.com/support/H390



בקר פנימי

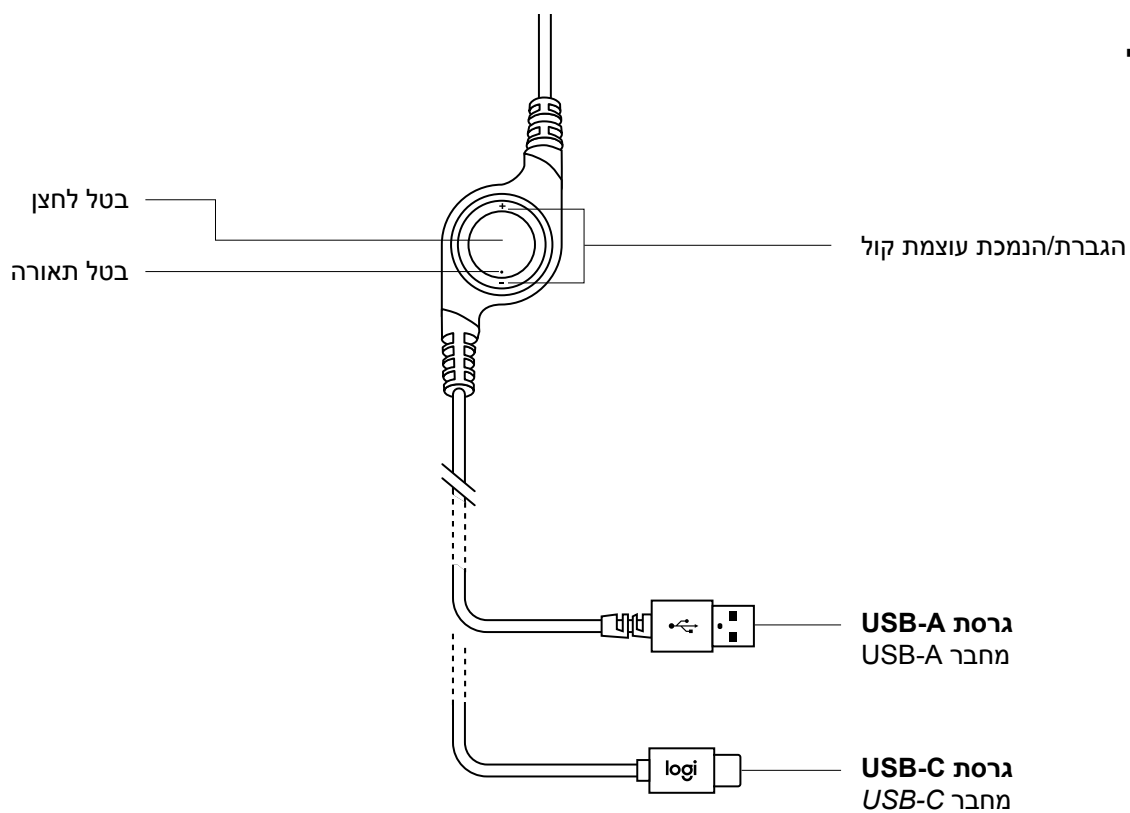

חיבור האוזניות

חבר את מחבר ה-USB ליציאת ה-USB של המחשב.

גרסת USB-A

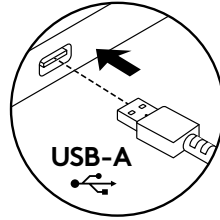

גרסת USB-C

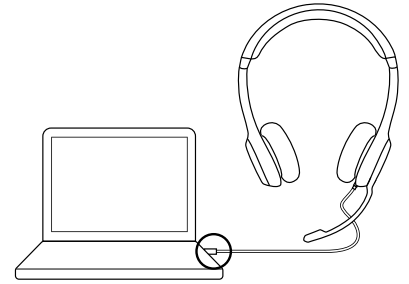
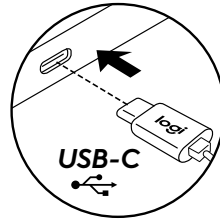

התאמת האוזניות

1. הזז את רצועת הראש כלפי מעלה ומטה על מנת לכוון את גודל האוזניה, עד אשר תותאם בנוחות.
2. הזז את הבום של המיקרופון כלפי מעלה ומטה עד אשר הוא מאוזן אל מול הפה ללכידת שמע טובה יותר.
3. כאשר לא נעשה שימוש בבום ניתן לקפל אותו.

1

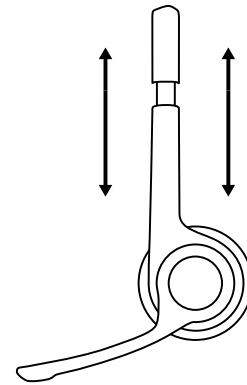

2

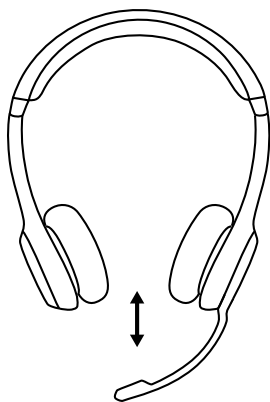

3

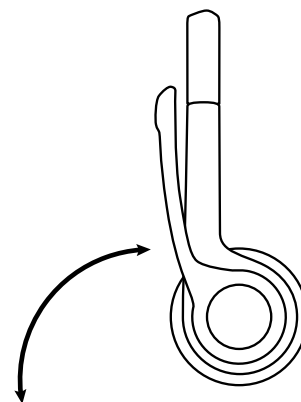

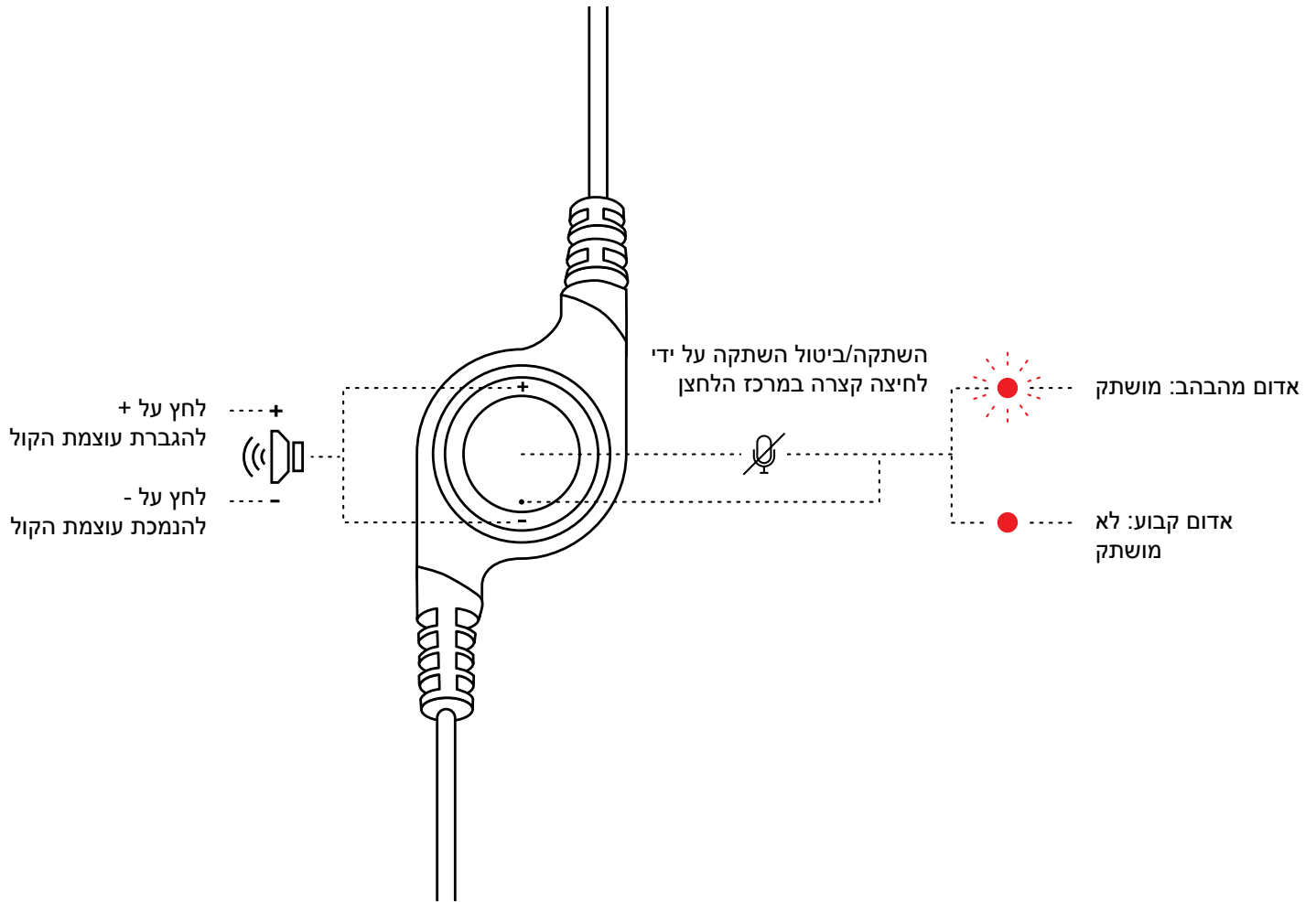

www.logitech.com/support/H390